

HIDROBOX MVD-W140RN3

Owner's manual

MAXI MVD V6R

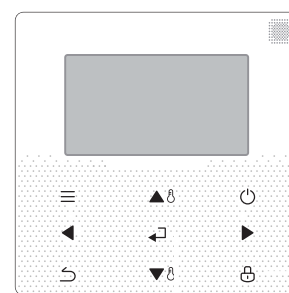

FR: "Manual d'utilisation et d'installation" voir www.mundoclima.com/fr
DE: "Benutzer- und Installationshandbuch" sehen www.mundoclima.com/de
PT: "Manual de instalação e do utilizador" ver www.mundoclima.com/pt



CONTENTS

1 GENERAL SAFETY PRECAUTIONS

- 1.1 About the documentation 01
- 1.2 For the user 01

2 A GLANCE OF THE USER INTERFACE

- 2.1 The appearance of the wired controller..... 02
- 2.2 Status icons 02

3 USING HOME PAGES..... 03

4 MENU 08

5 BASIC APPLICATION

- 5.1 Unlocking the screen 08
- 5.2 Enabling/Disabling mode and setting temperature 09

6 FUNCTIONS

- 6.1 Heat mode 12
- 6.2 Domestic hot water (DHW) 15
- 6.3 Schedule function 17
- 6.4 Options 20
- 6.5 Child lock 22
- 6.6 Service information 23
- 6.7 Operation parameters 24
- 6.8 User settings 27
- 6.9 On-site for serviceman settings 28

7 MENU STRUCTURE: OVERVIEW

- 7.1 Structure 31

8 MAINTENANCE

- 8.1 Error codes 33

ANNEX

1 GENERAL SAFETY PRECAUTIONS

1.1 About the documentation

The precautions described in this document cover very important topics, follow them carefully.

DANGER

Indicates a situation that results in death or serious injury.

DANGER: RISK OF ELECTROCUTION

Indicates a situation that could result in electrocution.

DANGER: RISK OF BURNING

Indicates a situation that could result in burning because of extreme hot or cold temperatures.

WARNING

Indicates a situation that could result in death or serious injury.

CAUTION

Indicates a situation that could result in minor or moderate injury.

NOTE

Indicates a situation that could result in equipment or property damage.

INFORMATION

Indicates useful tips or additional information.

1.2 For the user

If you are not sure how to operate the unit, contact your installer.

The appliance is not intended for use by persons, including children, with reduced physical, sensory or mental capabilities, or lack of experience and knowledge, unless they have been given supervision or instruction concerning use of the appliance by a person responsible for their safety. Children must be supervised to ensure that they do not play with the product.

CAUTION

DO NOT rinse the unit. This may cause electric shocks or fire.

Unit are marked with the following symbol:



This means that electrical and electronic products can not be mixed with unsorted household waste. Do NOT try to dismantle the system yourself: the dismantling of the system, treatment of the refrigerant, of oil and of other parts must be done by an authorized installer and must comply with applicable legislation. Units must be treated at a specialized treatment facility for reuse, recycling and recovery. By ensuring this product is disposed of correctly, you will help to prevent potential negative consequences for the environment and human health. For more information, contact your installer or local authority.

ATTENTION:

- Placed in a location away from radiation.
- Min. water pressure: 1 bar .
- Max. water pressure: 3 bar.
- Min. water temperature: 5°C.
- Max. water temperature: 80 °C.
- Please release pressure before disassembly, Gastightness Test 3.1Mpa for R134a loop, 4.0MPa for R410a loop.
- For appliances intended for use at altitudes exceeding 2000 m, the maximum altitude of use shall be stated.

2 A GLANCE OF THE USER INTERFACE

2.1 The appearance of the wired controller

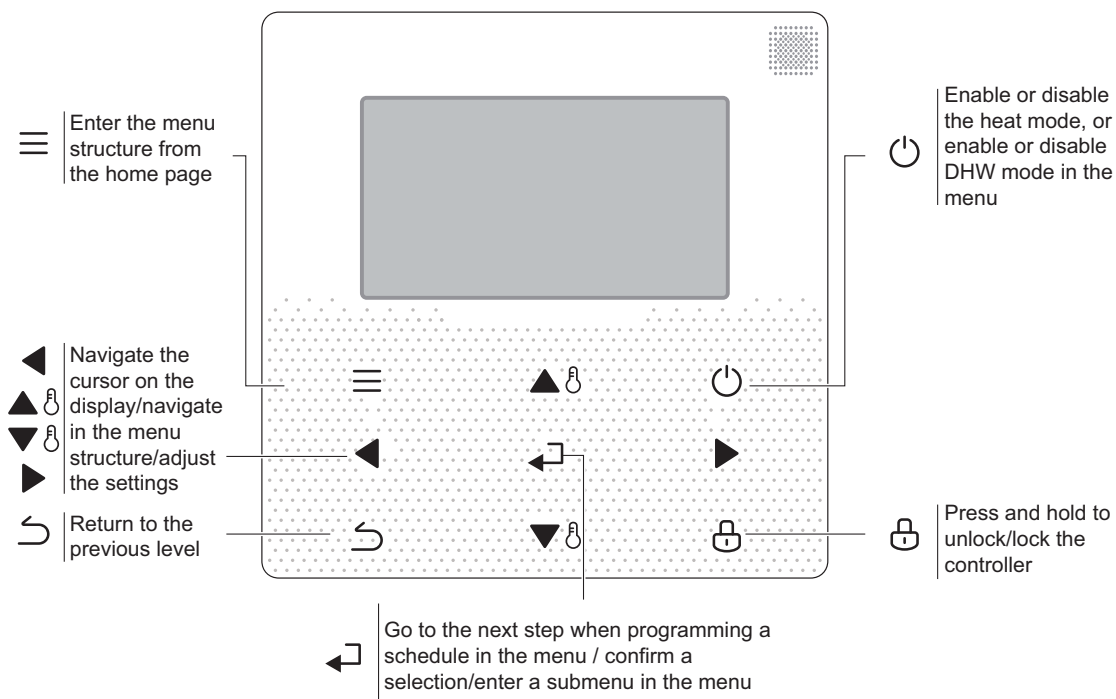

2.2 Status Icons

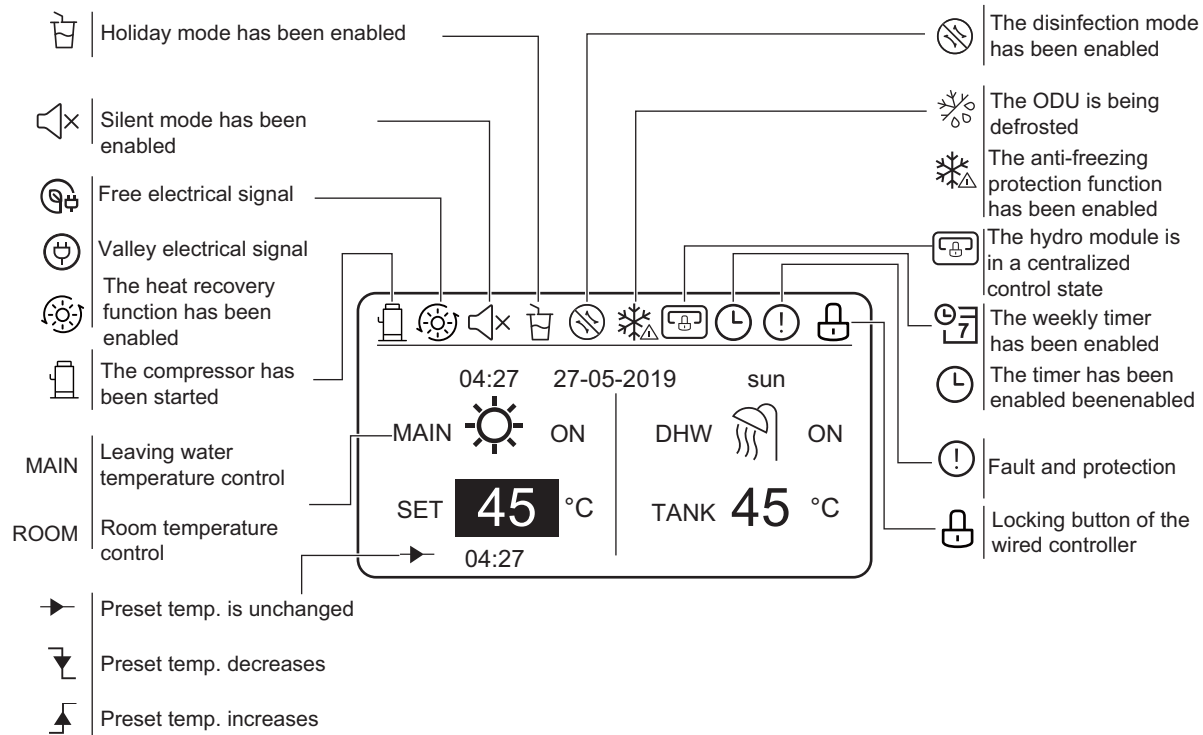

3 USING HOME PAGES

The hydro module features the heating function and DHW function, which can be classified into the hydro module that supports heat mode only ("FOR SERVICEMAN" > "Heat mode setting" > "HEAT MODE=YES" and "FOR SERVICEMAN" > "DHW mode setting" > "DHW MODE=NON"), the hydro module that supports DHW mode only (FOR SERVICEMAN" > "Heat mode setting" > "HEAT MODE=NON" and "FOR SERVICEMAN" > "DHW mode setting" > "DHW MODE=YES"), and the hydro module that supports both heat mode and DHW mode ("FOR SERVICEMAN" > "Heat mode setting" > "HEAT MODE=YES" and "FOR SERVICEMAN" > "DHW mode setting" > "DHW MODE=YES"). The heat mode is classified into leaving water temperature control ("FOR SERVICEMAN" > "Heat mode setting" > "LEAVING WATER TEMP.=YES") and room temperature control ("FOR SERVICEMAN" > "Heat mode setting" > "ROOM TEMP.=YES"). The leaving water temperature control and room temperature control is either-or. In leaving water temperature control mode, the hydro module sets the desired leaving water temperature and operates according to the defined desired temperature. In room temperature control mode, the hydro module sets the desired room temperature and conducts control according to the room temperature collected by the wired controller.

The wired controller interfaces are subject to on-site settings. Definitions of symbols of the wired controller:

ROOM---Room temperature control

MAIN---Leaving water temperature control

DHW--- Domestic hot water mode

Scenario 1

Only heating mode is available and the hydro module is operating in leaving water temperature control mode. (For more information, please read the Installation Manual.)

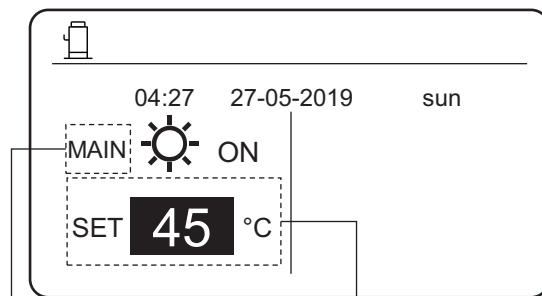
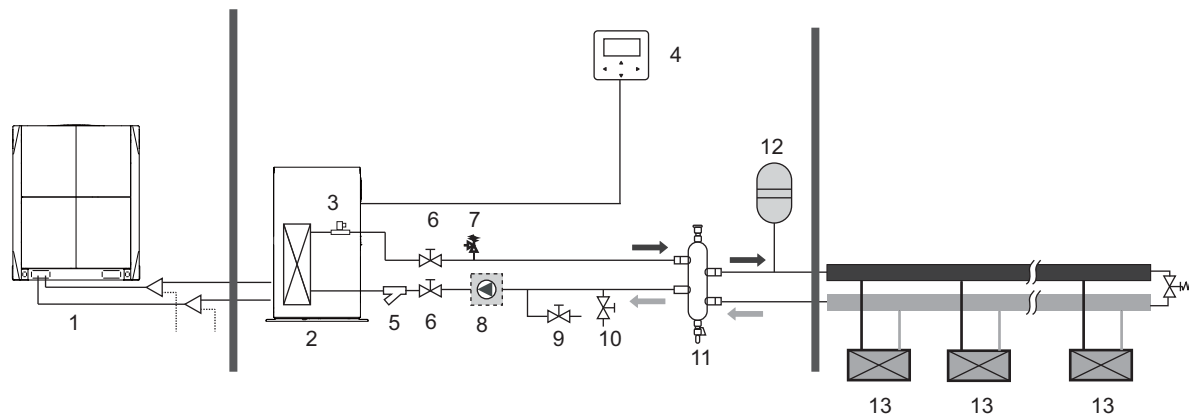

Indicates that the hydro module operates in leaving water temperature control mode.

Sets the desired leaving water temperature, ranging from 25°C to 80°C.

Scenario 2

Only heat mode is available and the hydro module operates in room temperature control mode. (For more information, please read the Installation Manual.)

Note: The wired controller must be installed indoors, where heating is required. The wired controller is equipped with a temperature sensor for detecting room temperature.

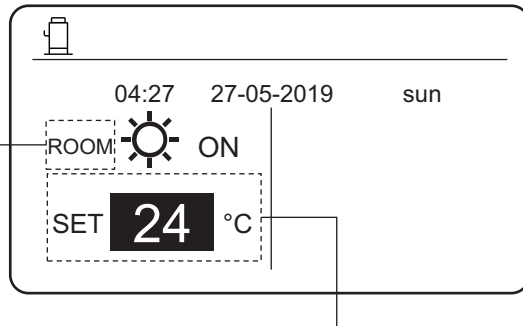
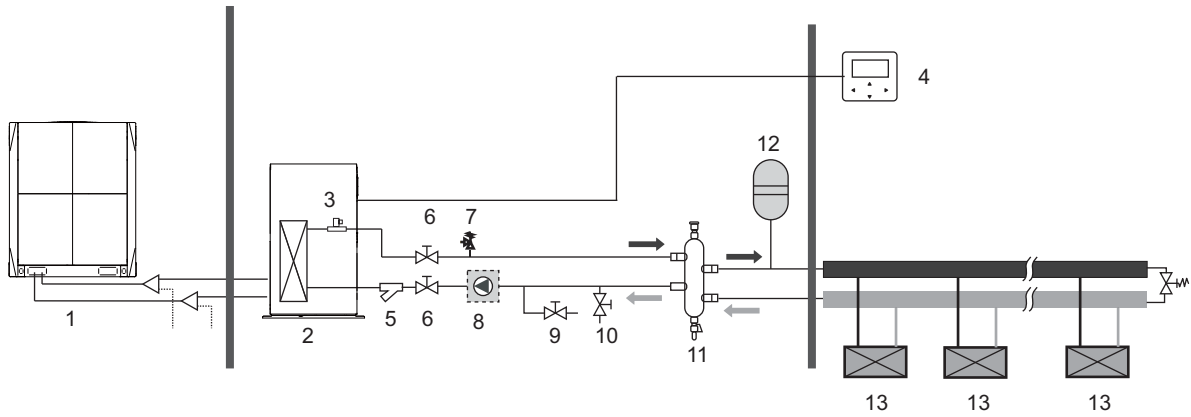

Indicates that the hydro module operates in room temperature control mode.

Sets the desired room temperature, ranging from 17°C to 30°C

Scenario 3

Only DHW mode is available. (For more information, please read the Installation Manual.)

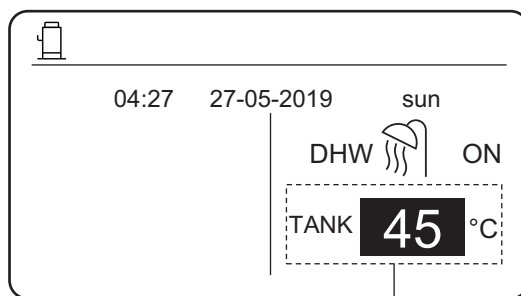
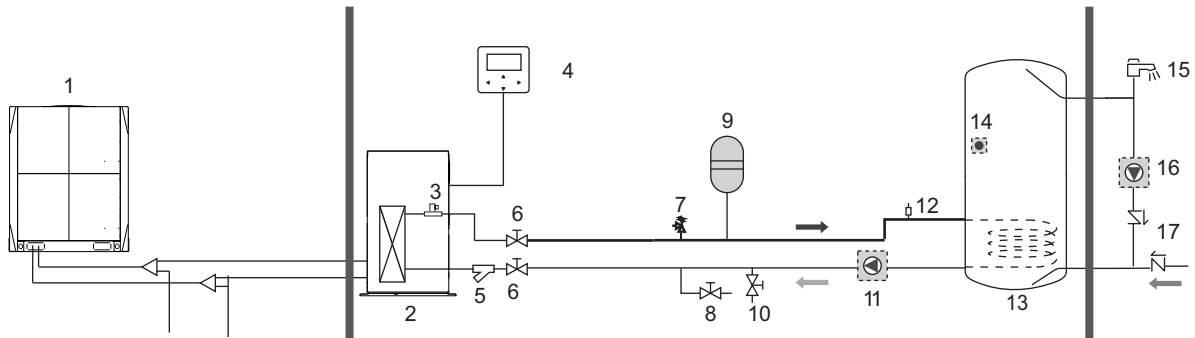

Sets the desired water tank temperature, ranging from 25°C to 80°C

Scenario 4

Both heat mode and DHW mode are available. (For more information, please read the Installation Manual.)

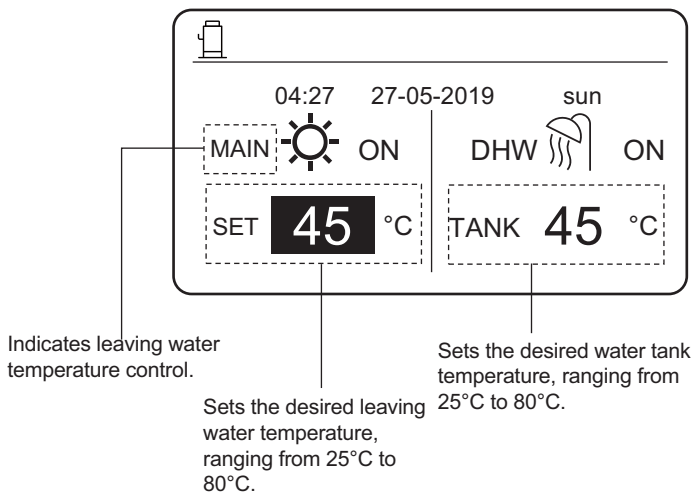
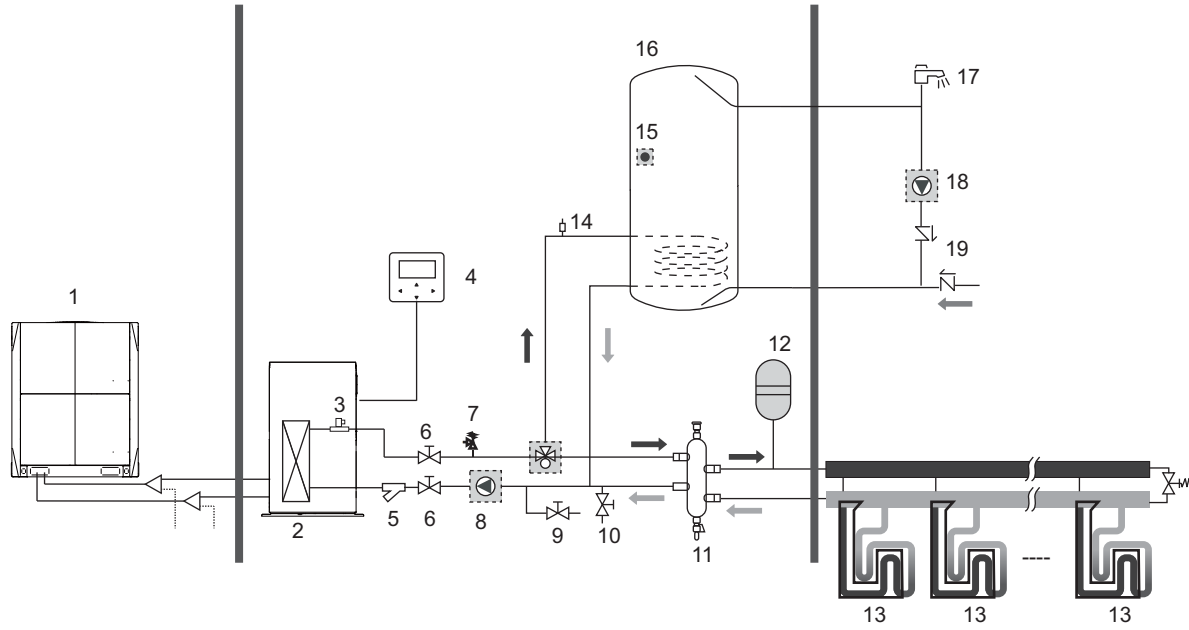

Scenario 5

Only heat mode is available and there are multiple set points for the heat mode. (For more information, please read the Installation Manual and see "Multiple Set Points" on Page 14 in this document.)

The settings of multiple set points do not affect the main interface. The temperature of multiple set points is set through the menu of the wired controller, while only the space 0 room temperature is set on the main interface.

Note: The temperature of multiple set point 2 is lower than the temperature of multiple set point 1 and the temperature of multiple set point 1 is lower than the temperature set on the main interface.

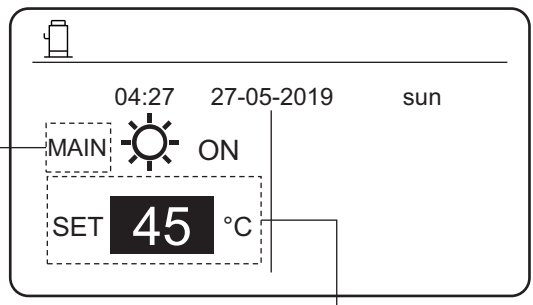
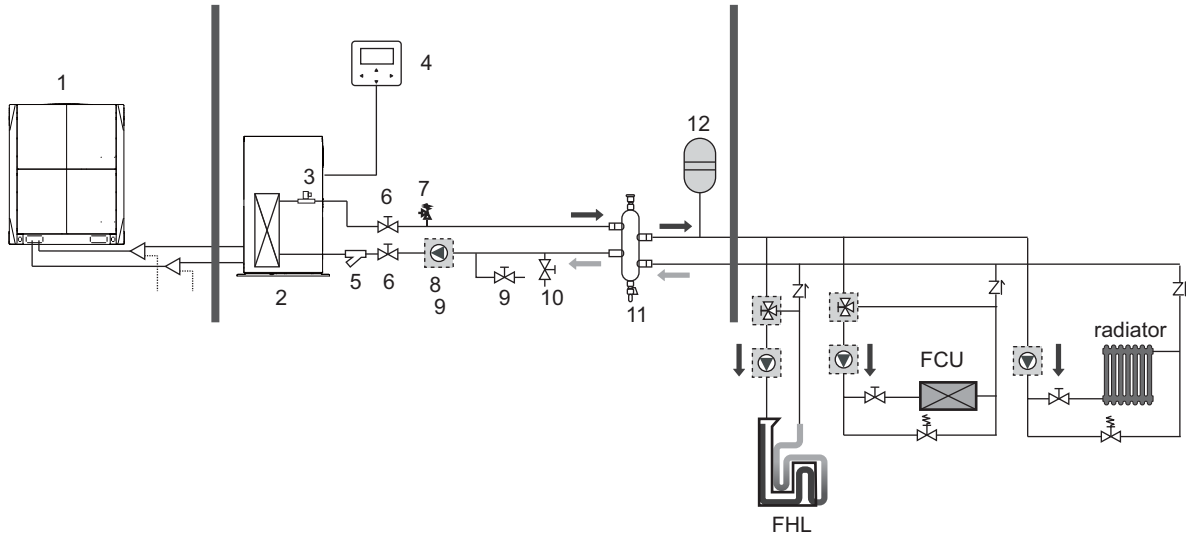

MAIN: Leaving water temperature control

Sets the desired temperature of the main set point.

ROOM: Room temperature control

Scenario 6

Group control of the hydro module.

When multiple hydro modules heat water in one water tank, the group control function of the hydro module should be used. (For more information, please read the Installation Manual.) The group control function is only valid for the DHW mode.

Notes:

1. The group control function of the hydro module is valid for the DHW mode only.
2. Master and slave hydro modules should be set. For instructions on how to set master and slave hydro modules, see the Installation Manual.
3. The master hydro module must be connected to a wired controller. The main wired controller can be used to set temperature.
4. The slave hydro module can be connected to or not connected to a wired controller. The slave wired controller provides limited functions, such as parameter query.
5. The circulating pump and water tank temperature sensor should be connected to the master hydromodule.

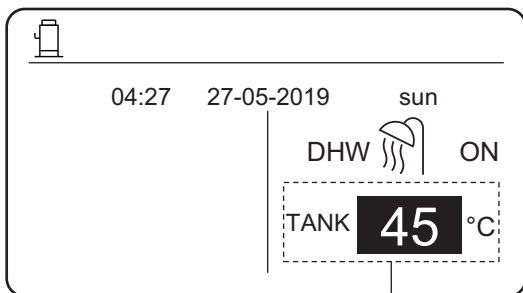
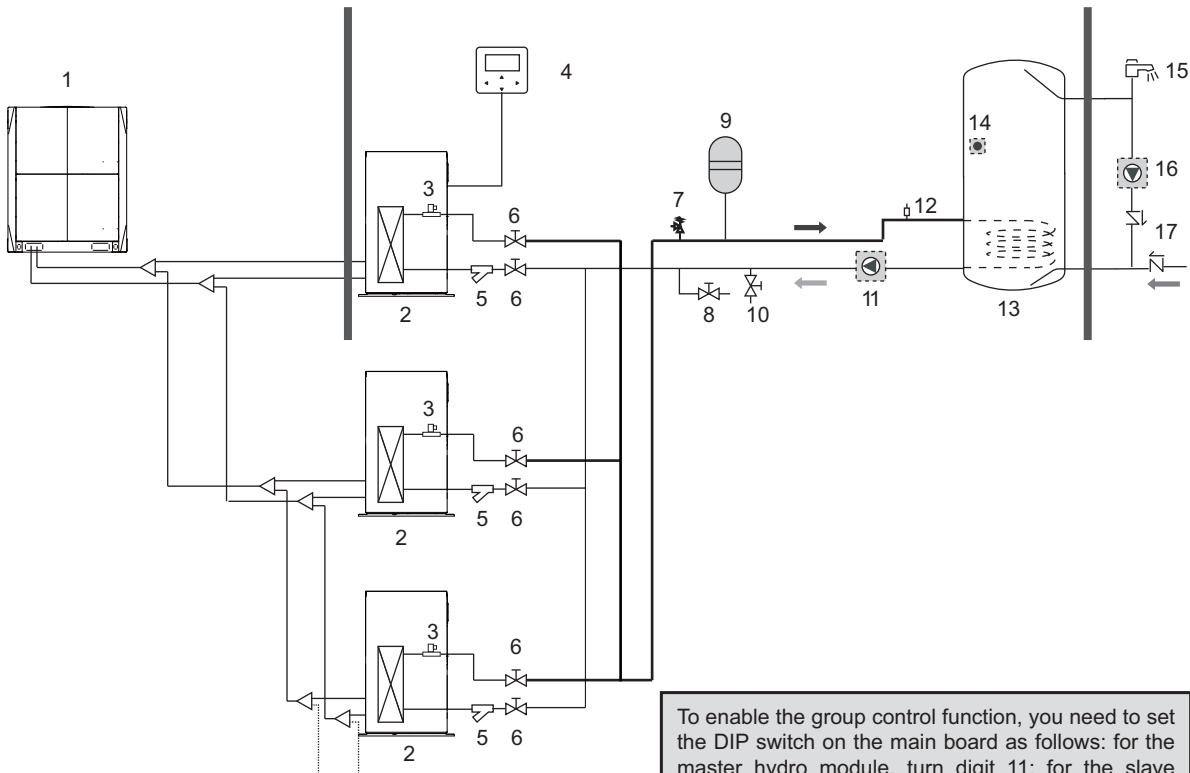

Sets the desired water tank temperature, ranging from 25°C to 80°C.

To enable the group control function, you need to set the DIP switch on the main board as follows: for the master hydro module, turn digit 11; for the slave hydro module, turn digit 10:

Group control function setting:
 00 and 01: Group control function is unavailable.
 11: Group control function is available. This hydro module is a master hydro module.
 10: Group control function is available. This hydro module is a slave hydro module.
 (By default, the value is 00, indicating that a controlled group contains only one master unit.)
 ON=1, OFF=0

Notes:

1. The master unit must be connected to a wired controller. The wired controller is used to set the desired water tank temperature.
2. The slave unit can be connected to or not connected to a wired controller. The wired controller of the slave unit provides the query function only.
3. The pump is controlled by the master unit. The temperature sensor of the water tank is connected to the master unit.
4. The wired controller connected to the master unit is used to set the desired water tank temperature.

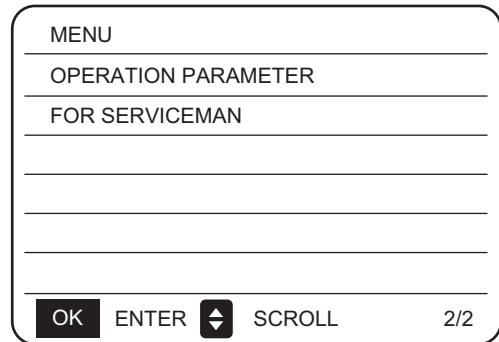
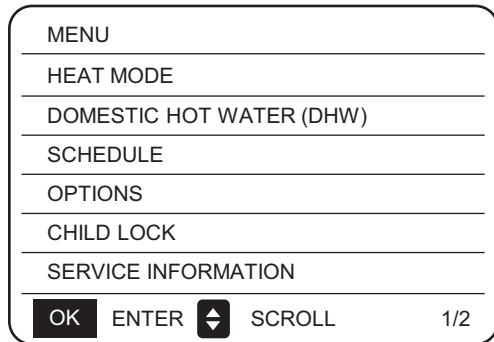

4 MENU

On the main interface, press **MENU**. The following interface is displayed.



5 BASIC APPLICATION

5.1 Unlocking the Screen

If the  icon is displayed on the screen, it indicates that the wired controller has been locked. If you press any key, the  icon blinks. Press and hold the **UNLOCK** key, the  icon will disappear. In this case, you can operate using the wired controller interface.

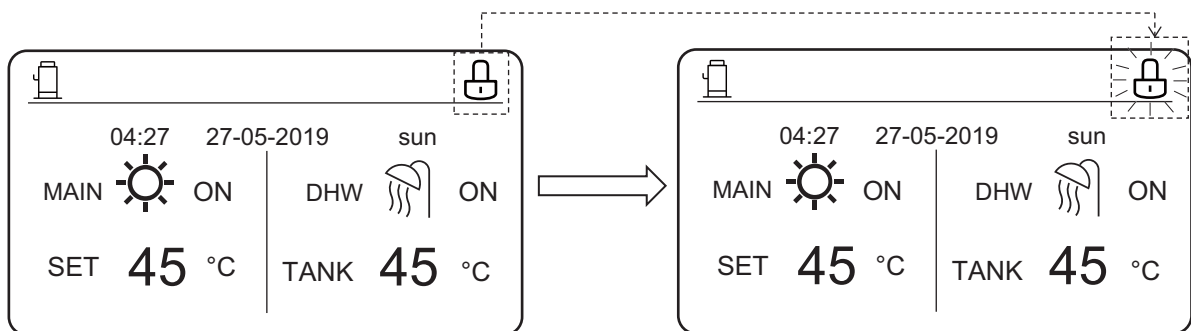

If you do not operate the wired controller for a long time (by default, 120s, which can be set on the wired controller. For details, see section 6.7 "Service Information"), the wired controller will lock automatically. If the wired controller is unlocked, press and hold the **UNLOCK** key, and the wired controller will be locked.

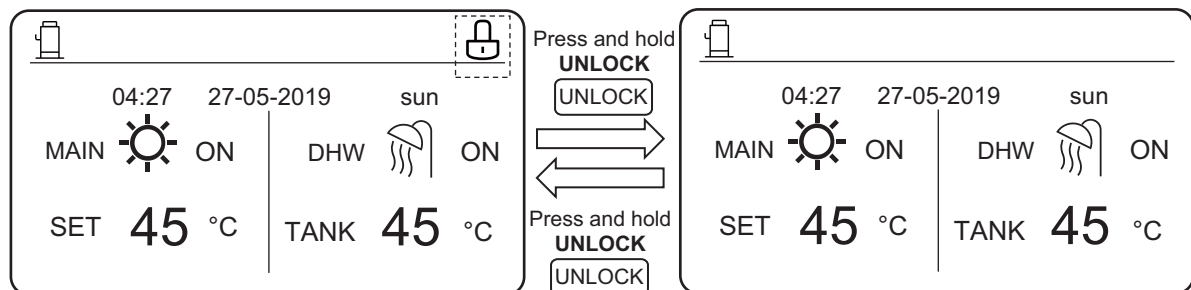

On the main interface, if you press the **ON/OFF** key, you cannot enable/disable any function, and the following prompt is displayed:

Press **▲** to enter main interface settings. Press **▶** or **◀** to select the mode to be set.

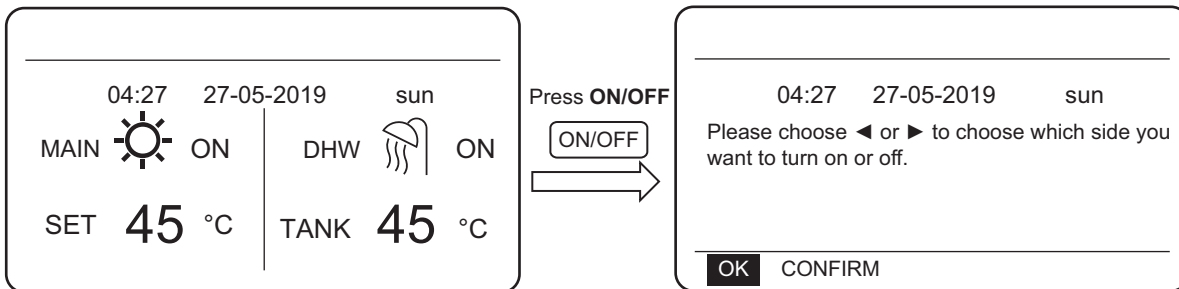

5.2 Enabling/Disabling Mode and Setting Temperature

Both heat mode and DHW mode can be enabled and disabled through the wired controller.

5.2.1 Heat Mode

There are two control methods for the heat mode:

- Leaving water temperature control
- Room temperature control

Leaving water temperature control

In leaving water temperature control mode, the hydro module operates according to the defined leaving water temperature so that the water outlet temperature reaches the desired leaving water temperature. The water outlet temperature can be set manually, or through the timer function.

- Steps for setting the leaving water temperature control mode of the hydro module: **MENU > FOR SERVICEMAN > HEAT MODE > LEAVING WATER TEMP.**
- Set **LEAVING WATER TEMP.** to **YES**.
- The desired leaving water temperature ranges from 25°C to 80°C.
- Sets the mode to leaving water temperature control and heating main interface to MAIN.

Notes:

If **LEAVING WATER TEMP.** is set to YES, **ROOM TEMP.** is automatically set to **NON**. If **ROOM TEMP.** is set to **YES**, **LEAVING WATER TEMP.** is automatically set to **NON**.

After setting, take the following steps to enable/disable the heat mode and adjust the desired water outlet temperature.

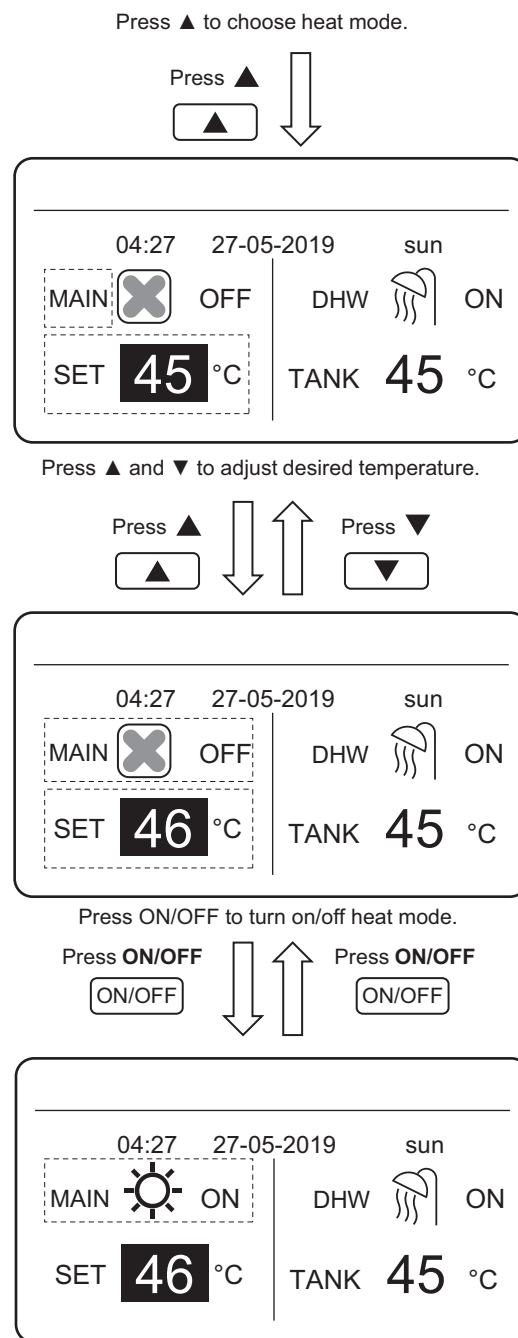
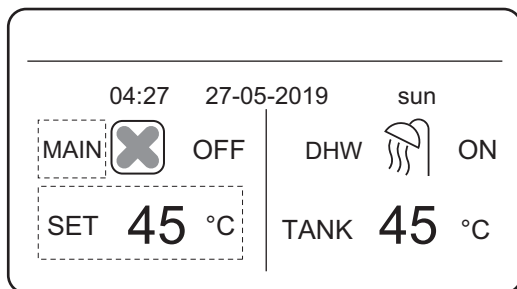

Room temperature control

In room temperature control mode, set the desired room temperature. The hydro module will control the operating of the hydro module according to the room temperature collected by the wired controller. The desired room temperature can be set manually, or through the timer function and weather temperature curve.

- Take the following steps to set room temperature control mode: **MENU > FOR SERVICEMAN > HEAT MODE > ROOM TEMP.**
- Set **ROOM TEMP.** to **YES**.
- Room temperature ranges from 17 C to 30 C.
- Sets the mode to water outlet temperature control and heating main interface to ROOM.

Notes:

1. The wired controller should be installed where heating is needed.

If **LEAVING WATER TEMP.** is set to **YES**, **ROOM TEMP.** is automatically set to **NON**. If **ROOM TEMP.** is set to **YES**, **LEAVING WATER TEMP.** is automatically set to **NON**.

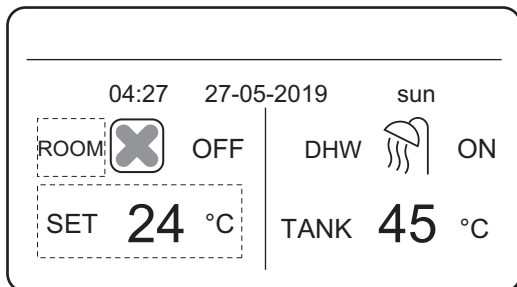

Press ▲ to choose heat mode.

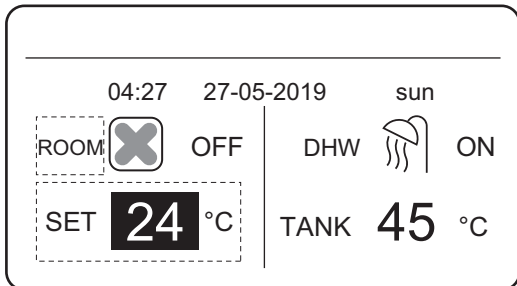

Press ▲ and ▼ to adjust desired temperature.

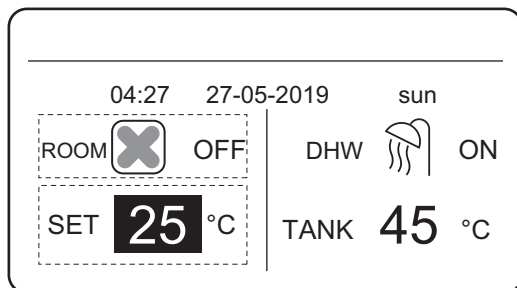

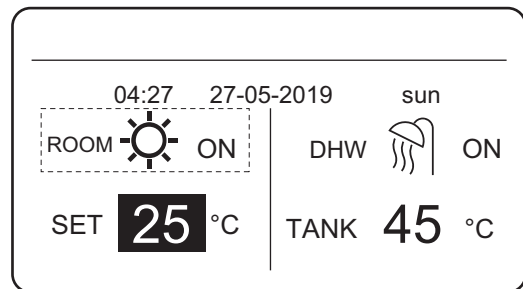
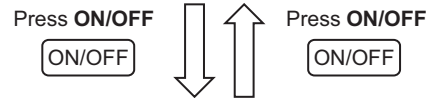

Press ON/OFF to turn on/off heat mode.

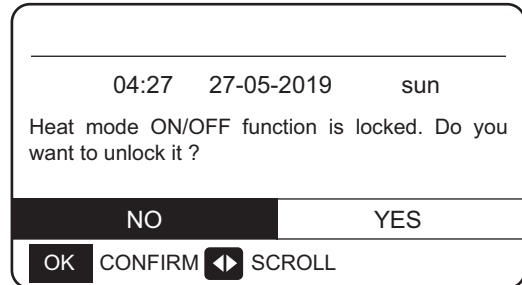
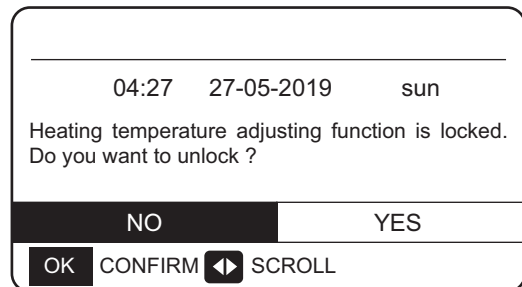

Assume that the temperature adjustment function in heat mode or mode on/off function are locked on the wired controller. If you adjust temperature or enable/disable a mode, the following interface is displayed:

If you press **NO**, you will return to the main interface. If you press **YES**, you will enter the **CHILD LOCK** interface.



If temperature adjustment function or mode on/off function are locked on the centralized controller, the  icon on the top will be lit. If you adjust temperature or enable/disable a mode on the wired controller, the following interface is displayed:

In this case, the hydro module can be only unlocked on the centralized controller.

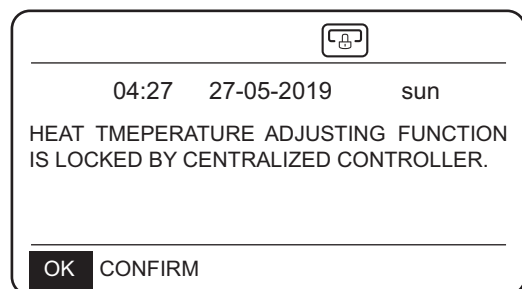

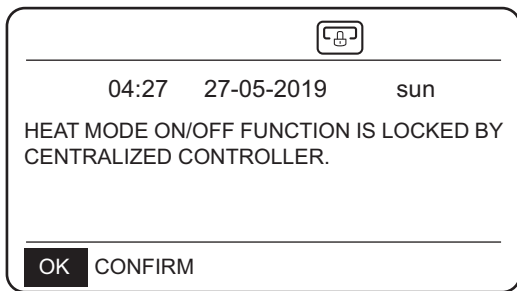

5.2.2 DHW Mode

- Take the following steps to set the DHW mode: **MENU > FOR SERVICEMAN > DHW MODE.**
- Set **DHW MODE** to **YES**.
- The water tank temperature ranges from 25°C to 80°C

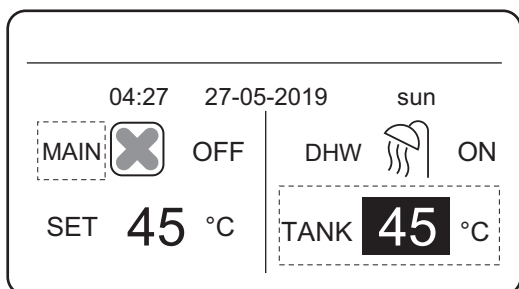

Press ▲ and ▼ to adjust desired temperature.

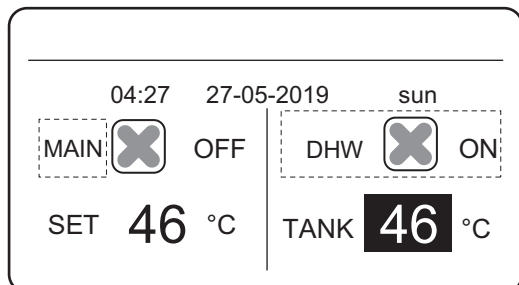
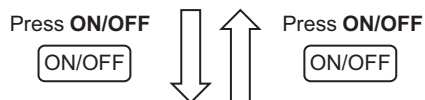
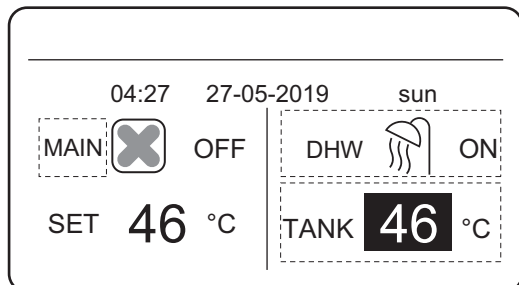
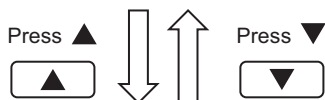

Press ON/OFF to turn on/off heat mode.

Assume that the temperature adjustment function in DHW mode or mode on/off function are locked on the wired controller. If you adjust temperature or enable/disable a mode, the following interface is displayed:

If you press **NO**, you will return to the main interface. If you press **YES**, you will enter the **CHILD LOCK** interface.

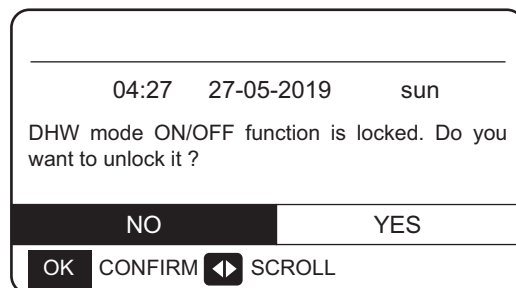
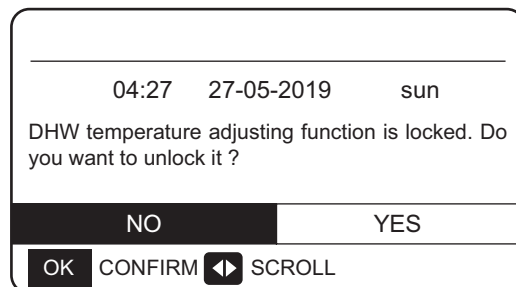

If temperature adjustment function or mode on/off function are locked on the centralized controller, the lock icon on the top will be lit. If you adjust temperature or enable/disable a mode on the wired controller, the following interface is displayed:

In this case, the hydro module can be only unlocked on the centralized controller.

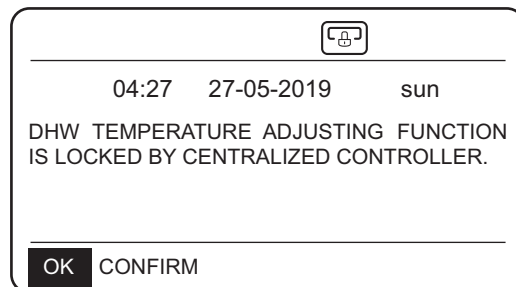
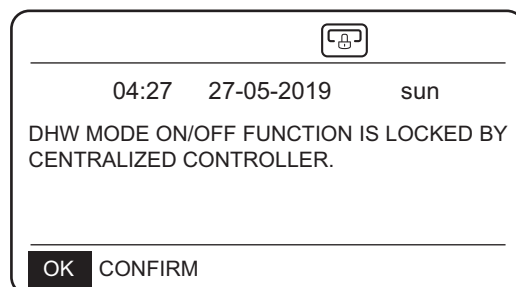

6 FUNCTIONS

6.1 HEAT MODE

In heat mode, PRESET TEMP., WEATHER TEMP., SET, MULTIPLE SET POINT are available.

6.1.1 PRESET TEMP.

PRESET TEMP. is used to set different desired water outlet temperatures at different times.

- PRESET TEMP. = PRESET TEMPERATURE
- The PRESET TEMP. function will be automatically disabled in the following conditions:
 - 1) Timer is set.
 - 2) Weekly schedule is set.

Take the following steps to enable PRESET TEMP.:
MENU > PRESET TEMPERATURE > PRESET TEMP.
 Press **OK**.

The following interface is displayed:

HEAT MODE		
PRESET TEMP.	WEATHER TEMP. SET	MULTIPLE SET POINT
No.	TIME	TEMP.
1	<input type="checkbox"/>	00:00 45°C
2	<input type="checkbox"/>	00:00 45°C
3	<input type="checkbox"/>	00:00 45°C

SCROLL 1/2

HEAT MODE		
PRESET TEMP.	WEATHER TEMP. SET	MULTIPLE SET POINT
No.	TIME	TEMP.
4	<input type="checkbox"/>	00:00 45°C
5	<input type="checkbox"/>	00:00 45°C
6	<input type="checkbox"/>	00:00 45°C

SCROLL 2/2

use "▲", "▼", "▶", "◀" to scroll and use "▲", "▼" to adjust the time and the temperature. When the cursor is on "■", as in the following page:

HEAT MODE		
PRESET TEMP.	WEATHER TEMP. SET	MULTIPLE SET POINT
No.	TIME	TEMP.
1	<input checked="" type="checkbox"/>	00:00 45°C
2	<input type="checkbox"/>	00:00 45°C
3	<input type="checkbox"/>	00:00 45°C

OK SELECT SCROLL 1/2

HEAT MODE		
PRESET TEMP.	WEATHER TEMP. SET	MULTIPLE SET POINT
No.	TIME	TEMP.
1	<input checked="" type="checkbox"/>	00:00 45°C
2	<input checked="" type="checkbox"/>	00:00 45°C
3	<input checked="" type="checkbox"/>	00:00 45°C

OK CANCEL SCROLL 1/2

Press "OK", and the "■" becomes "▣". The timer 1 is selected. Press "OK" again, and "▣" becomes "■". The timer 1 is unselected.

use "▲", "▼", "▶", "◀" to scroll and use "▲", "▼" to adjust the time and the temperature. Six temperatures can be set.

For example:

The time is 8:00 and temperature is 60°C. If PRESET TEMP. is set as follows, the hydro module will operate according to the following curve.

HEAT MODE		
PRESET TEMP.	WEATHER TEMP. SET	MULTIPLE SET POINT
No.	TIME	TEMP.
1	<input type="checkbox"/>	00:00 45°C
2	<input type="checkbox"/>	00:00 45°C
3	<input type="checkbox"/>	00:00 45°C
4	<input type="checkbox"/>	00:00 45°C
5	<input type="checkbox"/>	00:00 45°C
6	<input type="checkbox"/>	00:00 45°C

04:27 27-05-2019 sun
 MAIN ON
 SET 45 °C
 04:27

No.	TIME	TEMP.
1	8:00	70°C
2	12:00	60°C
3	15:00	70°C
4	18:00	60°C
5	20:00	70°C
6	23:00	60°C

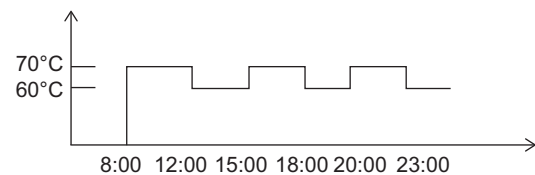

Notes:

1. When the multiple set point function is enabled, the PRESET TEMP. function is valid to space0 only.
2. If the hydro module is powered off, the preset temperature at the current time is invalid. The hydro module will be started at the time point where the next preset temperature is set.
3. When the timer function is valid, if you move the cursor to **PRESET TEMP.** and press the **OK** key, the following prompt is displayed:

HEAT MODE		
PRESET TEMP.	WEATHER TEMP. SET	MULTIPLE SET POINT
TIMER function is on.		
Do you want to turn off the timer function ?		
NO		YES
OK CONFIRM SCROLL		

4. The preset temperature is only valid for the water outlet temperature control of heat mode. If **ROOM TEMP.** is set to **YES** on the wired controller, the following information is displayed:

HEAT MODE		
PRESET TEMP.	WEATHER TEMP. SET	MULTIPLE SET POINT
SCROLL		

6.1.2 WEATHER TEMP. SET

- WEATHER TEMP. SET=WEATHER TEMPERATURE
- On the **WEATHER TEMP.SET** page, you cannot set the desired water outlet temperature. The desired water outlet temperature is calculated according to the outside ambient temperature. The higher the outside ambient temperature, the lower the desired water temperature.
- During the operation of the weather temperature curve, you can set the shift value of the weather temperature curve with the range of [-5,+5]. The shift value is the difference between the calculation value and the actual operation value. Example: +5°C indicates that the actual operation value is 5°C greater than the calculation value.
- Take the following steps to set the weather temperature curve: **MENU > PRESET TEMPERATURE > WEATHER TEMP. SET**. Press **OK**. The following interface is displayed:

HEAT MODE		
PRESET TEMP.	WEATHER TEMP. SET	MULTIPLE SET POINT
WEATHER TEMP. SET		OFF
SHIFT VALUE		0°C
SCROLL		

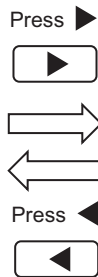

HEAT MODE		
PRESET TEMP.	WEATHER TEMP. SET	MULTIPLE SET POINT
WEATHER TEMP. SET		OFF
SHIFT VALUE		0°C
SCROLL		

Press ON/OFF button to turn on/off weather temperature function.



HEAT MODE		
PRESET TEMP.	WEATHER TEMP. SET	MULTIPLE SET POINT
WEATHER TEMP. SET		OFF
SHIFT VALUE		0°C
SCROLL		

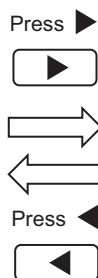

HEAT MODE		
PRESET TEMP.	WEATHER TEMP. SET	MULTIPLE SET POINT
WEATHER TEMP. SET		OFF
SHIFT VALUE		0°C
SCROLL		

Press "▲" or "▼" to adjust the shift value.

You can set the following 4 parameters in FOR SERVICEMAN. (See "FOR SERVICEMAN".)

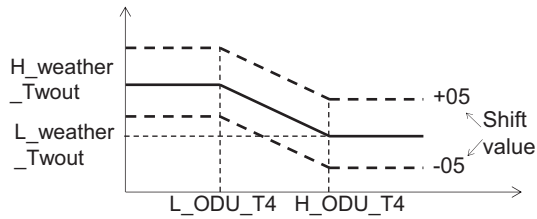

H_ODU_T4 : high outdoor temperature (indicates the high temperature point among outdoor ambient temperature)

L_ODU_T4 : low outdoor temperature (indicates the low temperature point among outdoor ambient temperature)

$L_weather_Twout$: the desired leaving water temperature when the outdoor temperature equals or drops below the low ambient temperature (indicates that the desired water outlet temperature is lower than the low temperature point of the outdoor ambient temperature)

$H_weather_Twout$: the desired leaving water temperature when the outdoor temperature equals or rises above the high ambient temperature (indicates the desired water outlet temperature is higher than the high temperature point of the outside ambient temperature)

If Weather TEMP.SET is enabled, you cannot set the desired water outlet temperature. If you press ▼ or ▲, the following interface is displayed.

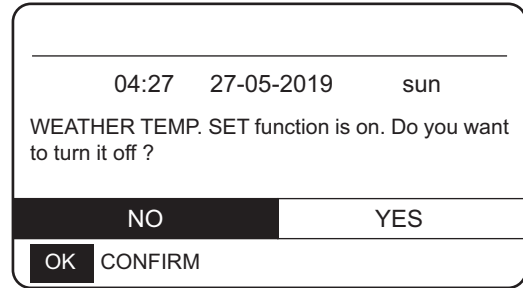

Press **OK** at **NO** to return to the main interface. Move the cursor to **YES**, and then press **OK**. The weather temperature curve setting interface is displayed as follows.

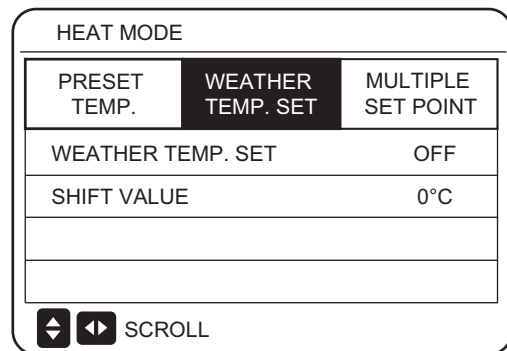

6.1.3 Multiple Set Point Function

When the hydro module is connected to multiple terminals that raise different water temperature requirements, you need to use the multiple set point function. The multiple set point function is used to set the desired water outlet temperature of space1 and space2. (For more information, please read the Installation Manual.)

The hydro module will calculate the space that requires energy and operate at the highest water temperature among the water outlet temperature requirements.

Note: For space 0, water temperature is set on the main interface.

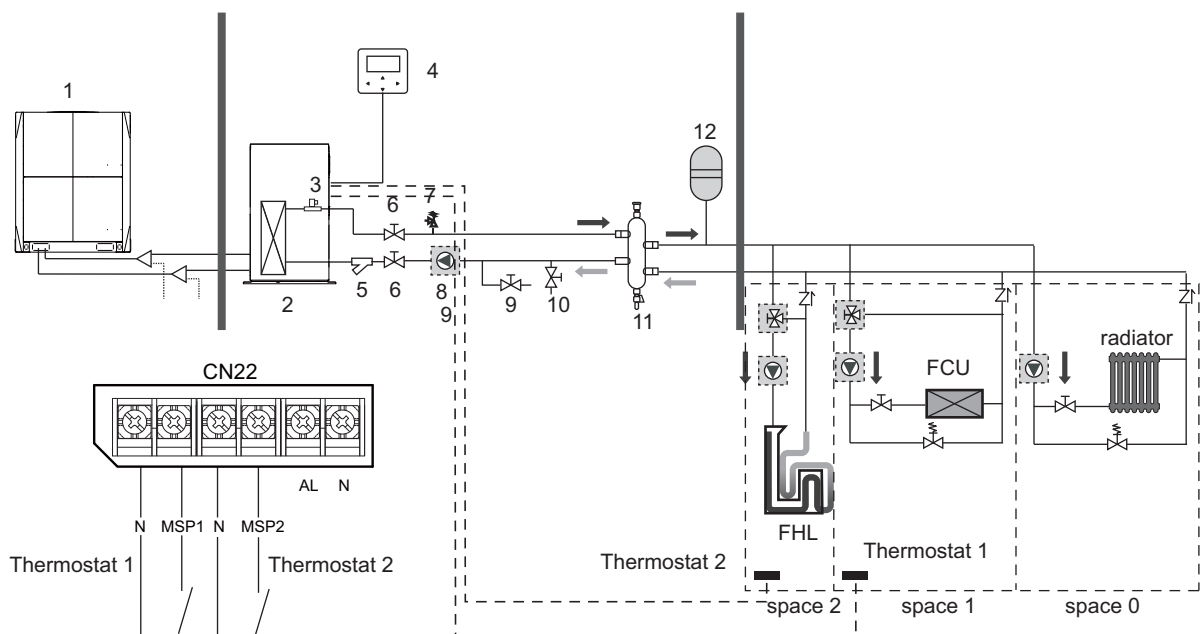

Notes:

1. The hydro module can meet the control requirements at different water temperatures. You must connect an external third-party temperature reduction device to the circuits of space1 and space2.

2. The multiple set point switch can be set on the FOR SERVICEMAN interface of the wired controller. If multiple set point 1=YES or multiple set point 2=YES, this indicates that multiple set points exist.

3. On the wired controller, multiple set point 1 required temp. is corresponding to the required water temperature of multiple set point 1, while multiple set point 2 required temp. is corresponding to the required water temperature of multiple set point 2.

4. The energy demand of space 1 is determined according to the thermostat 1. If thermostat 1 is on, it indicates that there is an energy demand, while if thermostat 1 is off, it indicates that energy is not demanded.

5. The energy demand of space 2 is determined according to the thermostat 2. If thermostat 2 is on, it indicates that there is an energy demand, while if thermostat 2 is off, it indicates that energy is not demanded.

HEAT MODE		
PRESET TEMP.	WEATHER TEMP. SET	MULTIPLE SET POINT
SPACE 1 DESIRED TEMP.		45 °C
SPACE 2 DESIRED TEMP.		30 °C
SCROLL		

	Desired temperature	Thermo status (energy demand status)			
		OFF	ON	OFF	OFF
space 0	a	OFF	ON	OFF	OFF
space 1	b	OFF	ON/OFF	ON	OFF
space 2	c	OFF	ON/OFF	ON/OFF	ON
Resulting desired temp.	OFF	a	b	c	

6.2 DOMESTIC HOT WATER (DHW)

DOMESTIC HOT WATER (DHW) has DISINFECT/DHW PUMP 2 items.

6.2.1 Disinfection Mode

In disinfection mode, legionella bacteria can be killed. In disinfection mode, the water tank temperature will forcedly rise to 70°C to 80°C. The disinfection temperature can be set on the FOR SERVICEMAN interface.

Choose **MENU > DOMESTIC HOT WATER > DISINFECT**. Press **OK**. The following interface is displayed.

DOMESTIC HOT WATER (DHW)	
DISINFECT	DHW PUMP
CURRENT STATE	OFF
OPERATION DAY	FRI.
START	23:00
SCROLL	



DOMESTIC HOT WATER (DHW)	
DISINFECT	DHW PUMP
CURRENT STATE	OFF
OPERATION DAY	FRI.
START	23:00
SCROLL	



DOMESTIC HOT WATER (DHW)	
DISINFECT	DHW PUMP
CURRENT STATE	ON
OPERATION DAY	FRI.
START	23:00
SCROLL	

Use “◀”, “▶”, “▼”, “▲” to scroll and use “▼”, “▲” to adjust the parameters when setting "OPERATE DAY" and "START". If the OPERATE DAY is set to FRIDAY and the START is set 23:00, the disinfect function will activate at 23:00 on Friday. If the disinfect function is running, the following page will appear:

23:00	27-05-2019	sun
ROOM ON	DHW ON	
SET 25 °C	TANK 45 °C	

Note:
When the hydro module operates in disinfection mode, if you press the **On/Off** key, the pressing is invalid and the following interface is displayed.

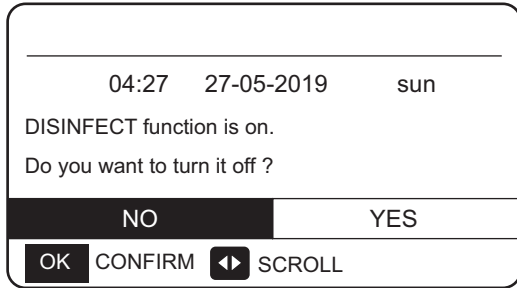

In disinfection mode, the hydro module will operate according to the following figure. The water temperature of the water tank will keep the disinfection temperature $T_{\text{tank_DI}}$.

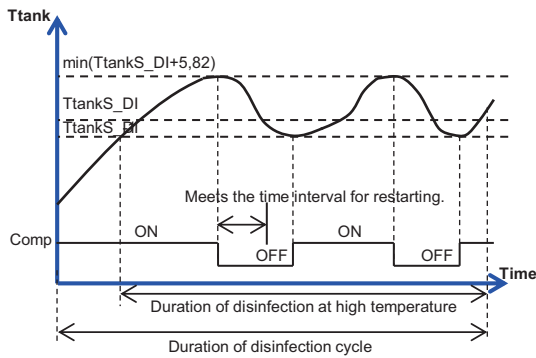

6.2.2 DHW PUMP

The DHW PUMP function is used to control the start time of the water tank and pump so that hot water can flow out of the tap at any time.

Choose **MENU > DOMESTIC HOT WATER > DHW PUMP**. Press **OK**. The following interface is displayed.

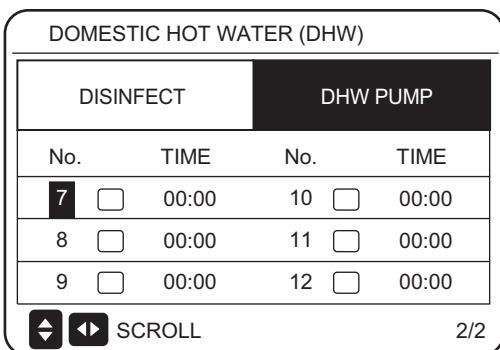
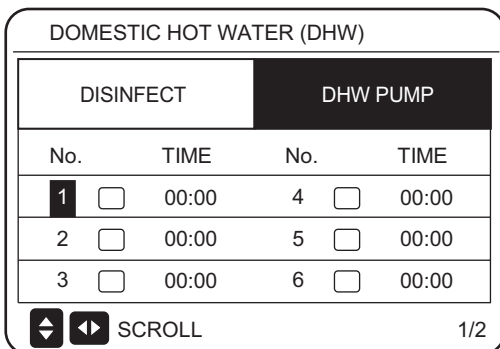

Move to "■", press "OK" to select or unselect. (☑ the timer is selected. ☐ the timer is unselected.)

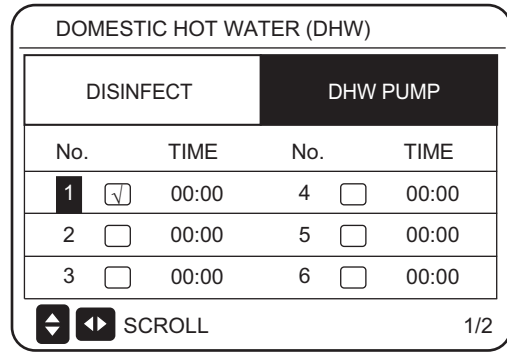

Use "◀", "▶", "▼", "▲" to scroll and use "▼", "▲" to adjust the parameters.

For example: You have set the parameter about the DHW PUMP (See "FOR SERVICEMAN" > "DHW MODE SETTING" on "Installation manual"). PUMP RUNNING TIME is 30 minutes.

Set as follows:

No.	START
1	06:00
2	07:00
3	08:00
4	09:00

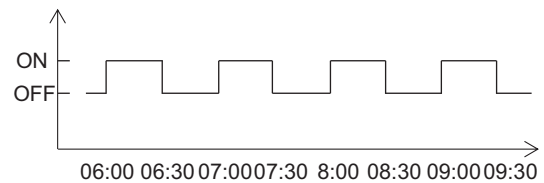

Notes:

1. If DHW MODE=NON, choose **MENU > DOMESTIC HOT WATER**. Press **OK**. The following interface is displayed.

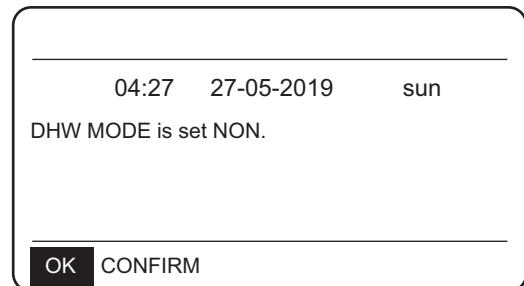

2. If DISINFECT MODE=NON on the FOR SERVICEMAN interface, choose **MENU > DOMESTIC HOT WATER > DOMESTIC HOT WATER**. Press **OK**. The following interface is displayed.

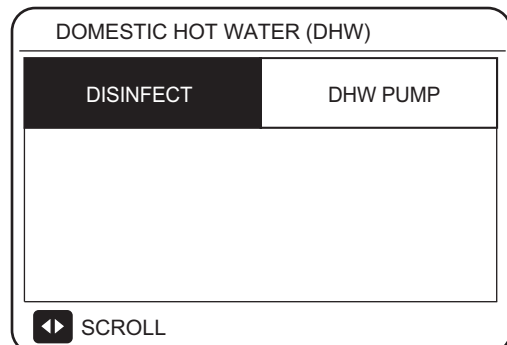

3. If DHW PUMP RUNNING TIME=NON, choose **MENU** > **DOMESTIC HOT WATER** > **DHW PUMP**. Press **OK**. The following interface is displayed.

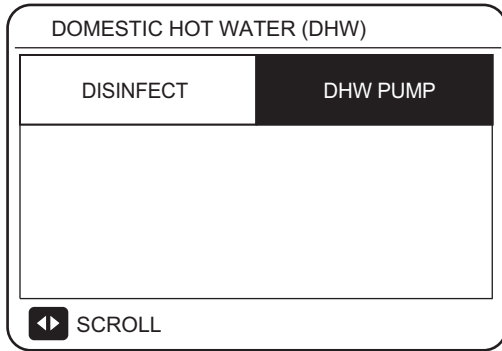

6.3 SCHEDULE Function

The **SCHEDULE** menu contains the following items:

- 1) TIMER
- 2) WEEKLY SCHEDULE
- 3) SCHEDULE CHECK
- 4) CANCEL TIMER

6.3.1 TIMER Function

If the timer function is enabled, the icon  will be displayed on the main interface of the wired controller. If the weekly schedule function is enabled, the timer function will be disabled.

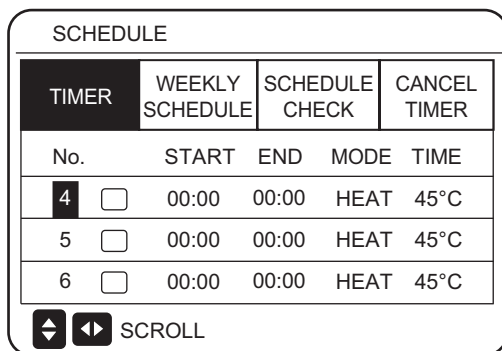
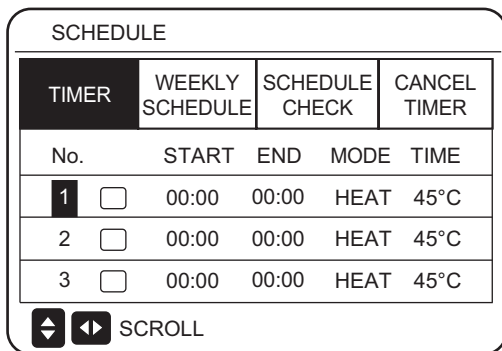

Use "◀", "▶", "▼", "▲" to scroll and use "▼", "▲" to adjust the time, the mode and the temperature.

Move to "■", press "OK" to select or unselect. (the timer is selected. the timer is unselected.) six timers can be set.

If you want to cancel the TIMER, change the cursor to "■", and press "OK". The will become , and the timer is disabled.

If the start time is later than the end time, the following interface is displayed.

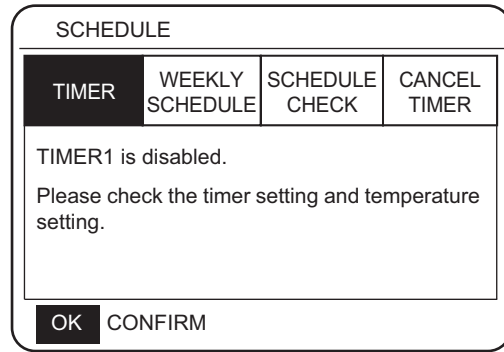

For example:

Six groups of schedules are set, as shown in the following table:

No.	START	END	MODE	TEMP.
1	1:00	3:00	DHW	70
2	7:00	9:00	HEAT	50
3	11:30	13:00	DHW	70
4	14:00	16:00	HEAT	50
5	15:00	19:00	DHW	70
6	18:00	23:30	HEAT	50

The hydro module will operate as shown in the following figure:



TIME	The operation of the controller
1:00	DHW mode is turned ON
3:00	DHW mode is turned OFF
7:00	HEAT MODE is turned ON
9:00	HEAT MODE is turned OFF
11:30	DHW MODE is turned ON
13:00	DHW MODE is turned OFF
14:00	HEAT MODE is turned ON
15:00	DHW MODE is turned ON and HEAT MODE is turned OFF
18:00	HEAT MODE is turned ON and DHW MODE is turned OFF
23:30	HEAT mode is turned OFF

Note:

If the start time is the same as the end time, the schedule is invalid.

6.3.2 WEEKLY SCHEDULE

Timer and weekly schedule cannot take effect at the same time. The time which is set later will take effect first. If the weekly schedule is set, the icon will be displayed on the main interface.

Choose **MENU > SCHEDULE > WEEKLY SCHEDULE**. Press **OK**. The following interface is displayed.

SCHEDULE						
TIMER	WEEKLY SCHEDULE	SCHEDULE CHECK	CANCEL TIMER			
MON.	TUE.	WED.	THU.	FRI.	SAT.	SUN.
<input checked="" type="checkbox"/>	<input type="checkbox"/>	<input type="checkbox"/>	<input type="checkbox"/>	<input type="checkbox"/>	<input type="checkbox"/>	<input type="checkbox"/>
ENTER			CANCEL			
OK	MON SELECT	↓	↔	SCROLL		

SCHEDULE						
TIMER	WEEKLY SCHEDULE	SCHEDULE CHECK	CANCEL TIMER			
MON.	TUE.	WED.	THU.	FRI.	SAT.	SUN.
<input type="checkbox"/>	<input type="checkbox"/>	<input type="checkbox"/>	<input type="checkbox"/>	<input checked="" type="checkbox"/>	<input type="checkbox"/>	<input type="checkbox"/>
ENTER			CANCEL			
OK	ENTER	↓	↔	SCROLL		

First select the days of the week you wish to schedule. Use "◀" and "▶" to scroll. Press "OK" to select or unselect the day. " " means that the day is selected, " **MON.** " means that the day is unselected.

Use "◀" or "▶" to SET, and press "ENTER". The Monday to Friday are selected to be scheduled and they have the same schedule. The following pages will appear:

SCHEDULE					
TIMER	WEEKLY SCHEDULE	SCHEDULE CHECK	CANCEL TIMER		
No.	START	END	MODE	TIME	
1	<input type="checkbox"/>	00:00	00:00	HEAT	45°C
2	<input type="checkbox"/>	00:00	00:00	HEAT	45°C
3	<input type="checkbox"/>	00:00	00:00	HEAT	45°C
OK	MON SELECT	↓	↔	SCROLL	

SCHEDULE					
TIMER	WEEKLY SCHEDULE	SCHEDULE CHECK	CANCEL TIMER		
No.	START	END	MODE	TIME	
4	<input type="checkbox"/>	00:00	00:00	HEAT	45°C
5	<input type="checkbox"/>	00:00	00:00	HEAT	45°C
6	<input type="checkbox"/>	00:00	00:00	HEAT	45°C
OK	MON SELECT	↓	↔	SCROLL	

Use "◀", "▶", "▼", "▲" to scroll and adjust the time, the mode and the temperature. Timers can be set, including start time and end time, mode and temperature. The mode includes heat mode and DHW mode. The setting method refer to timer setting. The end time must be later than the start time. Otherwise this will show that Timer is disabled.

6.3.3 SCHEDULE CHECK

Schedule check can only check the weekly schedule. Go to "MENU" > "SCHEDULE" > "SCHEDULE' CHECK". Press "OK". The following page will appear:

SCHEDULE			
TIMER	WEEKLY SCHEDULE	SCHEDULE CHECK	CANCEL TIMER
WEEKLY SCHEDULE CHECK.			
OK	ENTER	↓	↔

SCHEDULE					
DAY	No.	MODE	SET	START	END
	T1	<input type="checkbox"/>	HEAT	45°C	00:00 00:00
	T2	<input type="checkbox"/>	HEAT	45°C	00:00 00:00
	T3	<input type="checkbox"/>	HEAT	45°C	00:00 00:00
	T4	<input type="checkbox"/>	HEAT	45°C	00:00 00:00
	T5	<input type="checkbox"/>	HEAT	45°C	00:00 00:00
	T6	<input type="checkbox"/>	HEAT	45°C	00:00 00:00
	↓				
OK	ENTER	↓	↔	SCROLL	

Press "▼", "▲", the timer from Monday to Sunday will appear.

6.3.4 CANCEL TIMER

Go to "MENU" > "SCHEDULE" > "CANCEL TIMER". Press "OK". The following page will appear:

SCHEDULE			
TIMER	WEEKLY SCHEDULE	SCHEDULE CHECK	CANCEL TIMER
Do you want to cancel the timer and weekly schedule ?			
ON			
YES			
OK CONFIRM SCROLL			

Use "◀", "▶", "▼", "▲" to move to "YES". Press "OK" to cancel the timer. If you want to exit CANCEL TIMER, press "BACK". If TIMER or WEEKLY SCHEDULE is activated, the timer icon "⌚" or weekly schedule icon "📅" will display on the home page. If TIMER or WEEKLY SCHEDULE is canceled, icon "⌚" or "📅" will disappear on the home page.

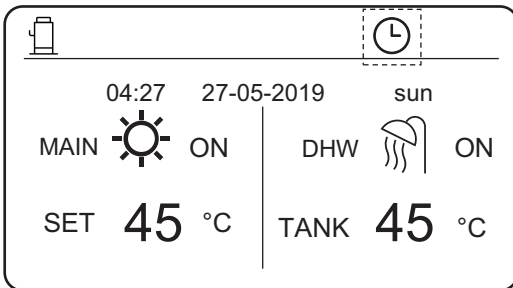

04:27 27-05-2019 sun

MAIN ON | DHW ON

SET 45 °C | TANK 45 °C

The timer icon (⌚) is highlighted with a dashed box.

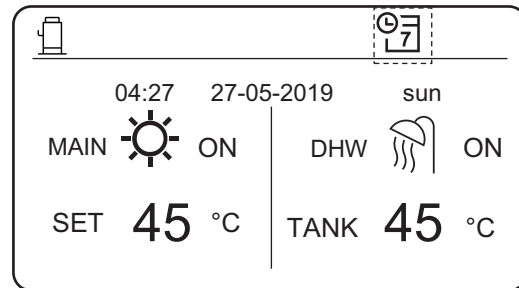

04:27 27-05-2019 sun

MAIN ON | DHW ON

SET 45 °C | TANK 45 °C

The weekly schedule icon (📅) is highlighted with a dashed box.

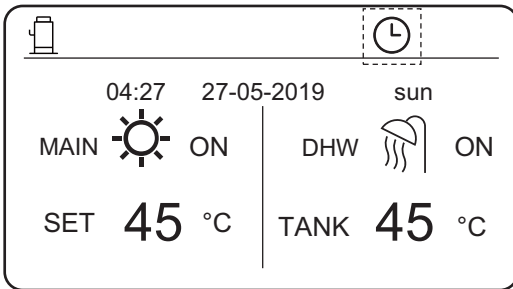

04:27 27-05-2019 sun

MAIN ON | DHW ON

SET 45 °C | TANK 45 °C

The timer icon (⌚) is highlighted with a dashed box.

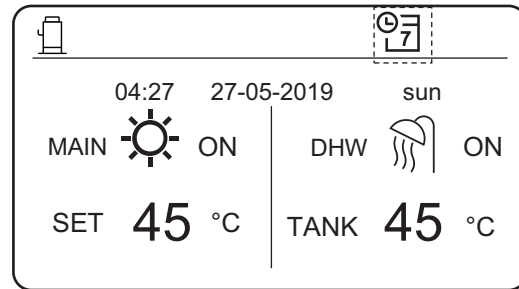

04:27 27-05-2019 sun

MAIN ON | DHW ON

SET 45 °C | TANK 45 °C

The weekly schedule icon (📅) is highlighted with a dashed box.

You have to reset TIMER/WEEKLY SCHEDULE, if you change the LEAVING WATER TEMP. to the ROOM TEMP. or you change the ROOM TEMP. to the LEAVING WATER TEMP.

6.4 OPTIONS

OPTIONS menu contents as follows:

- 1) SILENT MODE
- 2) HOLIDAY AWAY
- 3) HOLIDAY HOME

6.4.1 SILENT MODE

The silent mode is used to reduce the noise of the hydro module, which may degrade the capability of the hydro module. You can set the hydro module to always operate in silent mode or to enter silent mode within a period of time.

- On the main interface, you can check whether silent mode is enabled. If it is, the icon will be displayed on the main interface.
- Choose **MENU > OPTIONS > SILENT MODE**. Press **OK**. The following interface is displayed.

OPTIONS		
SILENT MODE	HOLIDAY AWAY	HOLIDAY HOME
CURRENT STATE		OFF
TIMER		ENTER

⏮ ⏪ SCROLL

OPTIONS		
SILENT MODE	HOLIDAY AWAY	HOLIDAY HOME
CURRENT STATE		OFF
TIMER		ENTER

ON/OFF ON/OFF ⏪ SCROLL

Choose **ON/OFF** to determine whether the silent mode is enabled. If **CURRENT STATE=OFF**, silent mode is invalid. If **CURRENT STATE=ON**, silent mode is valid. On the **TIMER** page, you can set the time for enabling the silent mode. Two periods of time can be set. The silent mode will be started at the **START** time, and disabled at the **END** time. If **TIMER** is not set, the hydro module will remain in silent mode.

OPTIONS		
SILENT MODE	HOLIDAY AWAY	HOLIDAY HOME
CURRENT STATE		OFF
TIMER		ENTER

⏮ ⏪ SCROLL

OPTIONS			
SILENT MODE	HOLIDAY AWAY	HOLIDAY HOME	
No.	START	END	
1	<input type="checkbox"/>	00:00	00:00
2	<input type="checkbox"/>	00:00	00:00



⏮ ⏪ SCROLL

6.4.2 HOLIDAY AWAY

If holiday away mode is enabled, the  icon will be displayed on the main interface.

The holiday away mode can prevent water from freezing during holidays and start heating and water heating before you are back home, thus guaranteeing comfort and hot water at home.



Go to "MENU" > "OPTIONS" > "HOLIDAY AWAY". Press "OK". The following page will appear:

OPTIONS		
SILENT MODE	HOLIDAY AWAY	HOLIDAY HOME
CURRENT STATE	OFF	
DHW MODE	ON	
DISINFECT	ON	
HEAT MODE	ON	
  SCROLL		



OPTIONS		
SILENT MODE	HOLIDAY AWAY	HOLIDAY HOME
CURRENT STATE	OFF	
DHW MODE	ON	
DISINFECT	ON	
HEAT MODE	ON	
ON/OFF ON/OFF  SCROLL 1/2		



OPTIONS		
SILENT MODE	HOLIDAY AWAY	HOLIDAY HOME
FROM	02-01-2019	
UNTIL	16-01-2019	
  SCROLL 2/2		

For example:

Assume that you plan to leave home for a winter vacation. If the current date is 2018-12-31 and you will start your holiday two days later, the holiday start date is 2019-01-02. If you have a two-week holiday and you want to save energy and prevent freezing at home, you can start holiday away mode as follows:

SETTING	VALUE
HOLIDAY AWAY	on
DHW MODE	on
DISINFECT	on
HEAT MODE	on
FROM	02-01-2019
UNTIL	16-01-2019



When DISINFECT is set to ON, and you set the disinfection mode, the hydro module will automatically perform disinfection at the set disinfection time prior to the end of the holiday. For example, if FROM=2020-01-02, UNTIL=2020-01-16, and disinfection time is set to 23:00 on Friday, disinfection begins from 23:00 on 2020-01-10. If you do not set the disinfection mode, the hydro module will forcedly enter disinfection mode at 22:00 on the day before the end of the holiday. If you do not set the disinfection mode, the hydro module will begin disinfection from 22:00 on 2020-01-16. After the hydro module exits disinfection mode, the wired controller will send the heat mode start-up command and DHW mode start-up command to the hydro module.

TwoutS=TwoutS_H.A_H indicates the heat mode, while TtankS=TtankS_H.A_DHW indicates the DHW mode. TwoutS_H.A_H and TtankS_H.A_DHW are set on the FOR SERVICEMAN interface of the wired controller.

Notes:

- In holiday mode, timer and weekly schedule are invalid until the hydro module exits from holiday mode.
- The CURRENT STATE option determines whether to enable holiday mode. If CURRENT STATE = OFF, HOLIDAY AWAY = OFF. If CURRENT STATE = ON, HOLIDAY AWAY = ON.
- The multiple set point is invalid when the hydro module operates in holiday mode.
- If disinfection mode is set in holiday mode, the hydro module will enter the disinfection mode at 22:00 on the day before the end of the holiday mode.
- In holiday mode, the weather temperature curve is invalid until the hydro module exits from holiday mode.
- In holiday mode, Preset Temp. is invalid until the hydro module exits from holiday mode.

If you operate the wired controller in holiday mode, the following prompt is displayed:

04:27 27-05-2019 sun		
The "HOLIDAY AWAY FUNCTION" is on. Do you want to turn off the holiday away function ?		
NO		YES
 CONFIRM  SCROLL		

6.4.3 HOLIDAY HOME Mode

In holiday home mode, the hydro module can operate according to the schedule settings of the holiday mode without affecting the normal schedule.

Period	Then...
Before an after your holiday	Your normal schedules will be used.
During your holiday	The configured holiday setting will be used.

If the holiday home mode is activated,  will display on the home page.

Go to "MENU" > "OPTIONS" > "HOLIDAY HOME". Press "OK". The following page will appear:

OPTIONS		
SILENT MODE	HOLIDAY AWAY	HOLIDAY HOME
CURRENT STATE		OFF
FROM		02-01-2019
UNTIL		16-01-2019
TIMER		ENTER
ON/OFF	ON/OFF	SCROLL

Use "ON/OFF" to select "OFF" or "ON" and use "◀", "▶", "▼", "▲" to scroll and adjust.

If the CURRENT STATE is OFF, the HOLIDAY HOME is OFF. If the CURRENT STATE is ON, the HOLIDAY HOME is ON. Use "▼" and "▲" to adjust the date. Before and after your holiday, your normal schedule will be used. During your holiday, you will save energy and prevent your house from freezing.

6.5 CHILD LOCK

The CHILD LOCK function is used to prevent children error operation. The mode setting and temperature adjusting can be locked or unlocked by using CHILD LOCK function.

Go to "MENU" > "CHILD LOCK". The page is displayed:

CHILD LOCK	
Please input the password:	
1	2 3
OK	ENTER ADJUST SCROLL

Input the correct password, and the following page will appear:

CHILD LOCK	
HEAT TEMP. ADJUST	UNLOCK
HEAT MODE ON/OFF	UNLOCK
DHW TEMP. ADJUST	UNLOCK
DHW MODE ON/OFF	UNLOCK
UNLOCK LOCK/UNLOCK SCROLL	

Notes:

1. If both **HOLIDAY AWAY** and **HOLIDAY HOME** are set to **ON**, **FROM** and **UNTIL** set on the **HOLIDAY AWAY** page cannot coincide or overlap with those set on the **HOLIDAY HOME** page. If they coincide or overlap, the following page is displayed:

04:27	27-05-2019	sun
The "HOLIDAY AWAY FUNCTION" is on. Do you want to turn off the holiday away function ?		
NO		YES
OK	CONFIRM	SCROLL

Press OK TO go back to the holiday away page.



OPTIONS		
SILENT MODE	HOLIDAY AWAY	HOLIDAY HOME
CURRENT STATE		OFF
DHW MODE		ON
DISINFECT		ON
HEAT MODE		ON
ON/OFF	ON/OFF	SCROLL 1/2

Use "▼" and "▲" to scroll and "ON/OFF" to select LOCK or UNLOCK.

The heat/DHW temperature can't be adjusted when the HEAT TEMP. ADJUST/DHW TEMP. ADJUST is locked. If you want to adjust the heat/DHW temperature when heat/DHW temperature is locked, the following page will appear:

The heat/DHW mode can't turn on or off when the HEAT/DHW MODE ON/OFF is locked. If you want to turn the heat/DHW mode on or off when HEAT/DHW MODE ON/OFF is locked, the following page will appear:

04:27 27-05-2019 sun

The heating temperature adjusting function is locked. Do you want to unlock it ?

NO YES

OK CONFIRM ◀▶ SCROLL

04:27 27-05-2019 sun

The heat mode ON/OFF function is locked. Do you want to unlock it ?

NO YES

OK CONFIRM ◀▶ SCROLL

04:27 27-05-2019 sun

The DHW temperature adjusting function is locked. Do you want to unlock it ?

NO YES

OK CONFIRM ◀▶ SCROLL

04:27 27-05-2019 sun

The DHW mode ON/OFF function is locked. Do you want to unlock it ?

NO YES

OK CONFIRM ◀▶ SCROLL

If you press NO, you will return to the home page. If you press YES, you will go to the CHILD LOCK page.

6.6 SERVICE INFORMATION

6.6.1 About service information

Service information menu contents are as follows:

- 1) SERVICE CALL
- 2) ERROR CODE
- 3) PARAMETER
- 4) DISPLAY

6.6.2 How to go to service information menu

Go to "MENU" > "SERVICE INFORMATION". Press "OK". The following page will appear:

The service call can show the service phone or mobile number. The installer can input the phone number. See "FOR SERVICEMAN".

SERVICE INFORMATION

SERVICE CALL	ERROR CODE	PARAMETER	DISPLAY
PHONE NO.		00000000000000000000	
MOBILE NO.		00000000000000000000	

◀▶ SCROLL

An error code is used to show when the fault happened and show the meaning of the error code.

SERVICE INFORMATION

SERVICE CALL	ERROR CODE	PARAMETER	DISPLAY
HB01#	E1	17:32	03-06-2019
HB01#	E2	09:20	04-06-2019
HB01#	Ed	12:10	20-06-2019
HB01#	PL	19:32	03-07-2019

◀▶ SCROLL 1/5

Press OK and the following page will appear:

SERVICE INFORMATION

SERVICE CALL	ERROR CODE	PARAMETER	DISPLAY
HB01#	E1	17:32	03-06-2019
HB01#	E2	09:20	04-06-2019
HB01#	Ed	12:10	20-06-2019
HB01#	PL	19:32	03-07-2019

OK ENTER ◀▶ SCROLL 1/5

Press OK to show the mean of the error code:

04:27 27-05-2019 sun		
HB01# E1		
Communication fault between controller and hydro box.		
Please contact your dealer.		
<input type="button" value="OK"/> CONFIRM		

NOTE:

A total of twenty fault codes can be recorded.

The parameter function is used to display the main parameter, and there are two pages to show the parameter:

SERVICE INFORMATION			
SERVICE CALL	ERROR CODE	PARAMETER	DISPLAY
		ROOM SET TEMP.	-°C
		MAIN SET TEMP	45°C
		TANK SET TEMP.	40°C
		ROOM ACTUAL TEMP.	-°C
<input type="button" value="↕"/> SCROLL			1/2

SERVICE INFORMATION			
SERVICE CALL	ERROR CODE	PARAMETER	DISPLAY
		MAIN ACTUAL TEMP.	25°C
		TANK ACTUAL TEMP.	25°C
<input type="button" value="↕"/> SCROLL			2/2

The DISPLAY function is used to set the interface:

SERVICE INFORMATION			
SERVICE CALL	ERROR CODE	PARAMETER	DISPLAY
		TIME	18:39
		DATE	03-06-2019
		LANGUAGE	EN
		BACKLIGHT	ON
<input type="button" value="↕"/> SCROLL			1/2

SERVICE INFORMATION			
SERVICE CALL	ERROR CODE	PARAMETER	DISPLAY
		BUZZER	ON
		SCREEN LOCK TIME	300 SEC
<input type="button" value="ON/OFF"/> <input type="button" value="ON/OFF"/> <input type="button" value="↔"/> SCROLL			2/2

Use "OK" to enter and use "◀", "▶", "▼", "▲" to scroll.

6.7 OPERATION PARAMETERS

Spot check the operating parameters of the hydro module and some operating parameters of the ODU.

This menu is for installer or service engineer reviewing the operation parameter of hydro box and ODU units.

- At the home page, go to "MENU" > "OPERATION PARAMETERS".
- Press "OK". There are six pages for the operating parameter as following. Use "▼", "▲" to scroll.

OPERATION PARAMETERS	
HYDRO BOX	
OUTDOOR UNITS	
<input type="button" value="OK"/> ENTER <input type="button" value="↔"/> SCROLL	

The parameters of hydro box are as follows:

OPERATION PARAMETERS	
OPERATION MODE	OFF
CURRENT	0.0 A
COMPRESSOR FREQUENCY	0 HZ
COMP. RUN TIME 1	1 MIN
COMP. RUN TIME 2	95 MIN
COMP. RUN TIME 3	3 MIN
<input type="button" value="↕"/> SCROLL	

OPERATION PARAMETERS	
COMP. RUN TIME 4	80 Hrs
EXPANSION VALVE 1	0 P
EXPANSION VALVE 2	0 P
TWOUT	25°C
TWIN	25°C
TTANK	25°C
<input type="button" value="↕"/> SCROLL	

OPERATION PARAMETERS	
TCS	25°C
PC	0 kPa
PE	0 kPa
TC	25°C
TE	25°C
T7C	25°C
SCROLL	3/6

OPERATION PARAMETERS	
T7	25°C
T3	25°C
T2A	25°C
TF	25°C
DSH	25°C
SSH	25°C
SCROLL	4/6

OPERATION PARAMETERS	
SC	25°C
PRIMARY CURRENT	0.0 A
SECONDARY CURRENT	0.0 A
PRIMARY VOLTAGE	0 V
POWER CONSUMPTION	0 W
HEAT POWER	0 W
SCROLL	5/6

OPERATION PARAMETERS	
HYDRO BOX SOFTWARE	V00
CONTROLLER SOFTWARE	V01
SCROLL	6/6

The parameters of ODU units are as follows:

OPERATION PARAMETERS	
HYDRO BOX	
OUTDOOR UNITS	
OK	ENTER
SCROLL	

OPERATION PARAMETERS	
ODU1_INV	0 HZ
ODU1_PC	0 kPa
ODU1_PE	0 kPa
ODU1_DSH	0 °C
ODU1_T4	25°C
ODU1_SOFTWARE	V01
SCROLL	1/3

OPERATION PARAMETERS	
ODU2_INV	0 HZ
ODU2_PC	0 kPa
ODU2_PE	0 kPa
ODU2_DSH	0 °C
ODU2_T4	25°C
ODU2_SOFTWARE	V01
SCROLL	2/3

OPERATION PARAMETERS	
ODU3_INV	0 HZ
ODU3_PC	0 kPa
ODU3_PE	0 kPa
ODU3_DSH	0 °C
ODU3_T4	25°C
ODU3_SOFTWARE	V01
SCROLL	3/3

Parameter	Content
OPERATION MODE	Operation Mode
CURRENT	Current
COMPRESSOR FREQUENCY	Compressor frequency
COMP. RUN TIME 1	Current compressor operation time
COMP. RUN TIME 2	Last compressor operation time
COMP. RUN TIME 3	Last two compressor operation time
COMP. RUN TIME 4	Compressor total operation time
EXPANSION VALVE 1	Electronic expansion valve 1
EXPANSION VALVE 2	Electronic expansion valve 2
TWOUT	Water outlet temperature
TWIN	Water inlet temperature
TTANK	Water tank temperature
TCS	Desired discharge pipe pressure saturation temperature
PC	Discharge pipe pressure
PE	Suction pipe pressure
TC	Discharge pipe pressure saturation temperature
TE	Scution pipe pressure saturation temperature
T7C	Discharge pipe temperature
T7	Suction pipe temperature
T3	Liquid pipe temperature on the R134a loop
T2A	Liquid pipe temperature on the R410a loop
TF	Module temperature
DSH	Discharge pipe superheat degree
SSH	Suction pipe superheat degree
SC	Subcooling degree of liquid pipe in R410a loop
PRIMARY CURRENT	Primary current
SECONDARY CURRENT	Secondary current
PRIMARY VOLTAGE	Primary voltage
POWER CONSUMPTION	Power consumption
HEAT POWER	Heat power capacity

6.8 User Settings

Code	Description	Default Value	Min. Value	Max. Value	Adjustment Step	Unit
TwoutS	Water outlet temperature of heating mode set on the main interface	45	25	80	1	°C
TaS	Room temperature of heating mode set on the main interface	24	17	30	1	°C
TtankS	Water tank temperature of DHW mode set on the main interface	50	25	80	1	°C
HEAT	Heat mode on/off: 0 = Off, 1 = On	0	0	1	1	/
DHW	DHW mode on/off: 0 = Off, 1 = On	0	0	1	1	/
PRESET TEMP. TIMER1	PRESET TEMP. timer 1 on/off: 0 = Off, 1 = On	0	0	1	1	/
PRESET TEMP. TIME1	PRESET TEMP. time 1	0:00	0:00	23:50	1/10	h/min
Temper.1	PRESET TEMP. 1	45	25	80	1	°C
PRESET TEMP. TIMER2	PRESET TEMP. timer 2 on/off: 0 = Off, 1 = On	0	0	1	1	/
PRESET TEMP. TIME2	PRESET TEMP. time 2	0:00	0:00	23:50	1/10	h/min
Temper.3	PRESET TEMP. 2	45	25	80	1	°C
PRESET TEMP. TIMER3	PRESET TEMP. timer 2 on/off: 0 = Off, 1 = On	0	0	1	1	/
PRESET TEMP. TIME3	PRESET TEMP. time 3	0:00	0:00	23:50	1/10	h/min
Temper.3	PRESET TEMP. 3	45	25	80	1	°C
PRESET TEMP. TIMER4	PRESET TEMP. timer 3 on/off: 0 = Off, 1 = On	0	0	1	1	/
PRESET TEMP. TIME4	PRESET TEMP. time 4	0:00	0:00	23:50	1/10	h/min
Temper.4	PRESET TEMP. 4	45	25	80	1	°C
PRESET TEMP. TIMER5	PRESET TEMP. timer 4 on/off: 0 = Off, 1 = On	0	0	1	1	/
PRESET TEMP. TIME5	PRESET TEMP. time 5	0:00	0:00	23:50	1/10	h/min
Temper.5	PRESET TEMP. 5	45	25	80	1	°C
PRESET TEMP. TIMER6	PRESET TEMP. timer 6 on/off: 0 = Off, 1 = On	0	0	1	1	/
PRESET TEMP. TIME6	PRESET TEMP. time 6	0:00	0:00	23:50	1/10	h/min
Temper.6	PRESET TEMP. 6	45	25	80	1	°C
weather temp. set	Temperature setting curve on/off: OFF = 0, ON = 1	0	0	1	1	/
shift value	Temperature setting curve shift value	0	-5	5	1	°C
multiple set point 1 required temp.	Sets water temperature at multiple set point 1	65	25	80	1	°C
multiple set point 2 required temp.	Sets water temperature at multiple set point 2	35	25	80	1	°C
DISINFECT CURRENT STATE	Disinfection on/off: OFF = 0, ON = 1	0	0	1	1	/
DISINFECT OPERATE DAY.	Disinfection week	FRI	MON	SUN	1	/
DISINFECT START	Start time for disinfection	23:00	0:00	23:50	1/10	h/min

Code	Description	Default Value	Min. Value	Max. Value	Adjustment Step	Unit
DHW PUMPTIMER1-16	Pipeline water return pump timer on/off: OFF = 0, ON = 1	0	0	1	1	/
DHW PUMP START 1-16	Pipeline water return pump start time: 1-16	0:00	0:00	23:50	1/10	h/min
TIMER1-TIMER6	Timers 1-6 on/off: 0 = Off, 1 = On	0	0	1	1	/
TIMER1-TIMER6 START	Timers 1-6 start time	0:00	0:00	23:50	1/10	h/min
TIMER1-TIMER6 END	Timers 1-6 end time	0:00	0:00	23:50	1/10	h/min
TIMER MODE 1-6	Timer mode: 0 = HEAT, 3 = DHW	0	0	3	1	/
TIMER TEMP. 1-6	Temperature setting timer	45	25	80	1	°C
CANCEL TIMER	Cancels all the defined timers	0	0	1	1	/
SILENT MODE CURRENT STATE	Silent mode on/off: 0 = Off, 1 = On	0	1	1	1	/
SILENT TIMER	Silent mode timer on/off: 0 = Off, 1 = On	1	0	1	1	/
SILENT MODE TIMER START 1	Silent mode timer start time 1	12:00	0:00	23:50	1/10	h/min
SILENT MODE TIMER END 1	Silent mode timer end time 1	15:00	0:00	23:50	1/10	h/min
SILENT MODE TIMER START 2	Silent mode timer start time 2	22:00	0:00	23:50	1/10	h/min
SILENT MODE TIMER ENDT 2	Silent mode timer end time 2	7:00	0:00	23:50	1/10	h/min
HOLIDAY AWAY CURRENT STATE	Holiday away mode on/off: 0 = Off, 1 = On	0	0	1	1	/
HOLIDAY AWAY DHW MODE	Holiday away DHW mode on/off: 0 = Off, 1 = On	1	0	1	1	/
HOLIDAY AWAY DISINFECT	Holiday away disinfection mode on/off: 0 = Off, 1 = On	1	0	1	1	/
HOLIDAY AWAY HEAT MODE	Holiday away heat mode on/off: 0 = Off, 1 = On	1	0	1	1	/
HOLIDAY AWAY FROM	Holiday away start date	Current date + 1	1/1/2018	1/1/2100	1	/
HOLIDAY AWAY UNTIL	Holiday away end date	Current date + 8	1/1/2018	1/1/2100	1	/
HOLIDAY home CURRENT STATE	Holiday home mode on/off: 0 = Off, 1 = On	0	0	1	1	/
HOLIDAY home FROM	Holiday home start date	Current date	1/1/2018	1/1/2100	1	/
HOLIDAY home UNTIL	Holiday home end date	Current date + 7	1/1/2018	1/1/2100	1	/
HOLIDAY home TIMER	Holiday home timer on/off: 0 = Off, 1 = On	0	0	1	1	/
CURRENT TIME	Current time	0:00	0:00	23:59	1/10	h/min
CURRENT DATE	Current date	1/1/2018	1/1/2018	1/1/2100	1	/
LANGUAGE	Language: EN = 0, FR = 1, IT = 2, SP = 3, PL = 4, DE = 5, TR = 6	0	0	5	1	/
BACKLIGHT	Backlight on/off: 0 = Off, 1 = On	1	0	1	1	/
BUZZER	Buzzer on/off: 0 = Off, 1 = On	1	0	1	1	/
SCREEN LOCK TIME	Screen locking time	120	60	300	10	Second

6.9 On-site FOR SERVICEMAN Settings

6.9.1 About FOR SERVICEMAN

FOR SERVICEMAN is used for installers and service engineers.

- Setting the function of equipment.
- Setting the parameters.

6.9.2 How to Go to FOR SERVICEMAN

Go to "MENU" > "FOR SERVICEMAN". Press "OK".

- The FOR SERVICEMAN is used for installers or service engineers. It is NOT intended for home owners to alter setting with this menu.
- It is for this reason that password protection is required to prevent unauthorised access to the service settings.
- The password is 234.

6.9.3 How to Exit FOR SERVICEMAN

If you have set all the parameters. Press "BACK", and the following page will appear:

Select "YES" and press "OK" to exit the FOR SERVICEMAN. After exiting the FOR SERVICEMAN, the unit will be turned off.

6.9.4 Settings of Special Functions

6.9.4.1 Max. Power Limitation Function

This function can limit the power consumption of the hydro module. Choose **MENU > FOR SERVICEMAN > POWER INPUT LIMITATION**. Press **OK**. The following interface is displayed.

Select speed. 0 = Not limited; 1 = Speed 1; 2 = Speed 2; 3 = Speed 3.

Speed 0: It indicates that the maximum current for hydro module operation is 16 A.

Speed 1: It indicates that the maximum current for hydro module operation is 15 A.

Speed 2: It indicates that the maximum current for hydro module operation is 14 A.

Speed 3: It indicates that the maximum current for hydro module operation is 13 A.

6.9.4.2 Heat Recovery Function

This function will automatically enable the heat recovery function of the hydro module to produce hot water when the start-up capacity of the chiller's IDU is great. Choose **MENU > FOR SERVICEMAN > HEAT RECOVERY MODE SETTING**. Press **OK**. The following interface is displayed.

HEAT RECOVERY=YES indicates that the heat recovery function is enabled. HEAT RECOVERY=NON indicates that heat recovery function is disabled.

Ttank_recovery_max indicates that the desired tank temperature of the heat recovery function is set.

6.9.5 Meanings of Each Setting Item

Code		Description	Default Value	Min. Value	Max. Value	Adjustment Step	Unit
DHW MODE SETTING	DHW MODE	DHW mode on/off: 0 = NON, 1 = YES	1	0	1	1	/
	DISINFECT MODE	Disinfection on/off: 0 = NON, 1 = YES	1	0	1	1	/
	DHW PRIORITY	Water heating priority on/off: 0 = NON, 1 = YES	1	0	1	1	/
	dTtankSH	Power-on return difference of water heating	5	2	10	1	°C
	TtankS_DI	Sets temperature for disinfection	65	60	70	1	°C
	t_DI_HIGHTEMP.	Duration of disinfection at high temperature	15	5	60	5	MIN
	t_DI_MAX	Longest disinfection duration	210	90	300	5	MIN
	DHW PUMP RUNNING TIME	Time-based control of pipeline water return pump on/off: 0 = Off, 1 = On	1	0	1	1	/
HEAT MODE SETTING	HEAT MODE	Heat mode on/off: 0 = NON, 1 = YES	1	0	1	1	/
	LEAVING WATER TEMP.	Water outlet temperature control on/off: 0 = NON, 1 = YES	1	0	1	1	/
	ROOM TEMP.	Room temperature control on/off: 0 = NON, 1 = YES	0	0	1	1	/
	t_ODU_T4_FRESH_H	Weather temperature curve T4 refresh time in heat mode	0.5	0.5	6	0.5	hours
	dTwoutSH	Power-on return difference in heat mode (Water outlet temperature control)	5	2	10	1	°C
	dTaSH	Power-on return difference in heat mode (ambient temperature sensor control Ta)	2	1	10	1	°C
WEATHER TEMP. SETTING	L_weather_Twout	Water outlet temperature at low air temperature	70	25	80	1	°C
	H_weather_Twout	Water outlet temperature at high air temperature	45	25	80	1	°C
	L_ODU_T4	Low ambient temperature	-10	-20	5	1	°C
	H_ODU_T4	High ambient temperature	15	10	20	1	°C
MULTIPLE SET POINT SETTING	multiple set point 1	Multiple set point 1 on/off: 0 = OFF, 1 = YES	0	0	1	1	/
	multiple set point 2	Multiple set point 2 on/off: 0 = OFF, 1 = YES	0	0	1	1	/
HOLIDAY AWAY SETTING	TwoutS_H.A_H	Water outlet temperature of holiday mode	25	28	80	1	°C
	TtankS_H.A_DHW	Water tank temperature of holiday mode	40	25	80	1	°C
HEAT RECOVERY MODE SRTTING	HEAT RECOVERY	Heat recovery mode on/off: 0 = NON, 1 = YES	1	0	1	1	/
	Ttank_recovery_max	Max. heat recovery water tank temperature	70	45	80	1	°C
POWER INPUT LIMITATION	POWER INPUT LIMITATION	Sets input power limitation gear: 0 = Not limited, 1 = Gear 1, 2 = Gear 2, 3 = Gear 3	0	0	3	1	/
SMART GRID	SMART GRID	Sets smart grid on/off: 0 = NON, 1 = YES	1	0	1	1	/
	Ttank_smartgrid_max	Sets the highest water tank temperature of the smart grid	70	45	80	1	°C
HYDRO BOX ADDERSSING	HYDRO BOX ADDERSSING	Sets hydro module address	0	0	63	1	/
TEST RUN	VACUUM PUMPING	Sets vacuumizing mode on/off	0	0	1	1	/
	CIRCULATED PUMP RUNNING	Sets external water pump on/off	0	0	1	1	/
	DHW PUMP RUNNING	Sets water tank and pump on/off	0	0	1	1	/

7 MENU STRUCTURE: OVERVIEW

7.1 STRUCTURE

MENU

1	Heat mode
2	Domestic hot water(DHW)
3	Schedule
4	Options
5	Child lock
6	Service information
7	Operation parameter
8	For serviceman

1	Preset temp.
2	Weather temp. set
1	Disinfect
2	DHW pump
1	Timer
2	Weekly schedule
3	Schedule check
4	Cancel timer
1	Silent mode
2	Holiday away
3	Holiday home
1	Heat temp. adjust
2	Heat mode on/off
3	DHW temp. adjust
4	DHW mode on/off
1	Service call
2	Error code
3	Parameter
4	Display
1	Hydro box
2	Outdoor units
1	DHW mode setting
2	Heat mode setting
3	Weather temp. setting
4	Multiple set point setting
5	Holiday away setting
6	Service call
7	Restore factory setting
8	Test run
9	Heat recovery mode setting
10	Power input limitation
11	SMART GRID
12	Hydro box addressing

1	DHW MODE
2	Disinfect mode
3	DHW priority
4	dTtankSH
5	TtankS_DI
6	t_DI_HIGHTEMP.
7	t_DI_MAX
8	DHW PUMP RUNNING TIME
1	HEAT MODE
2	LEAVING WATER TEMP.
3	ROOM TEMP.
4	t_ODU_t4_FRESH_H
5	dTwoutSH
6	dTaSH
1	L_weather_Twout
2	H_weather_Twout
3	L_ODU_T4
4	H_ODU_T4
1	Multiple set point 1
2	Multiple set point 2
1	TwoutS_H.A_H
2	TtankS_H.A_DHW
1	HEAT RECOVERY
2	Ttank_recovery_max
1	POWER INPUT LIMITATION
1	SMART GRID
2	Ttank_smartgrid_max
1	HYDRO BOX ADDRESSING

8 MAINTENANCE

NOTE

Before repair and maintenance, ensure that the hydro module is powered off.

- Water pressure

Check if the water pressure is above 0.3 bar. Add water if necessary.

- Water filter

Clean the water filter.

- Water pressure relief valve

Check for correct operation of the pressure relief valve by turning the red knob along the valve counter-clockwise:

1. If you do not hear a clacking sound, contact your local dealer.
2. If water keeps running out of the unit, close both the water inlet and outlet shut-off valves first and then contact your local dealer.

- Pressure relief valve hose

Check that the pressure relief valve hose is positioned appropriately to drain the water. If the drain pan kit is installed, make sure that the pressure relief valve hose end is positioned in the drain pan.

- Auxiliary heater vessel insulation cover

Check that the auxiliary heater insulation cover is fastened tightly around the auxiliary heater vessel.

- Sanitary hot water tank pressure relief valve (field supply)

Applies only to installations with a sanitary hot water tank. Check for correct operation of the pressure relief valve on the sanitary hot water tank.

- Sanitary hot water electric heater

Applies only to installations with a sanitary hot water tank. It is advisable to remove lime buildup on the electric heater to extend its life span, especially in regions with hot water. To do so, drain the sanitary hot water tank, remove the electric heater from the sanitary hot water tank and immerse in a bucket (or similar) with lime-removing product for 24 hours.

- Indoor unit control box

1. Carry out a thorough visual inspection of the control box and look for obvious defects such as loose connections or defective wiring.
2. Check for correct operation of contactors by the use of an ohmmeter. All of these contactors must be in open position.

Important information for the used refrigerant

This product has the fluorinated gas, it is forbidden to release to air.

Refrigerant type: R410A/ Kg or R134a / Kg

Volume of GWP: 2088 or 1430; tonnes CO₂ equivalent

GWP=Global Warming Potential

ATTENTION:

Frequency of Refrigerant Leak Checks

- 1) For equipment that contains fluorinated greenhouse gases in quantities of 5 tonnes of CO₂ equivalent or more, but of less than 50 tonnes of CO₂ equipment, at least every 12 months, or where a leakage detection system is installed, at least every 24 months.
- 2) For equipment that contains fluorinated greenhouse gases in quantities of 50 tonnes of CO₂ equivalent or more, but of less than 500 tonnes of CO₂ equipment, at least every six months, or where a leakage detection system is installed, at least every 12 months.
- 3) For equipment that contains fluorinated greenhouse gases in quantities of 500 tonnes of CO₂ equivalent or more, at least every three months, or where a leakage detection system is installed, at least every six months.
- 4) This air-conditioning unit is a hermetically sealed equipment that contains fluorinated greenhouse gases.
- 5) Only certificated person is allowed to do installation, operation and maintenance.

8.1 Error Codes

Error code	Content
FE	Undefined address error
EE	EEPROM error
C7	PL protection appears three times in 100 minutes
E9	EEPROM mismatch
H4	Inverter module protection
H5	P2 protection appears three times in 60 minutes
H6	P4 protection appears three times in 100 minutes
1F6	Electronic expansion valve 1 connection error
2F6	Electronic expansion valve 2 connection error
E1	Communication error between hydro module and wired controller
E8	Water flow failure
F3	Water outlet temperature sensor error
F9	Water inlet temperature sensor error
F5	Tank temperature sensor error
E7	Discharge pipe temperature sensor error
FA	Suction pipe temperature sensor error
F7	IDU same address error
FC	R410a loop liquid pipe temperature sensor error
Fd	R134a loop liquid pipe temperature sensor error
F8	Room temperature sensor error
H8	High pressure sensor error
Hb	Low pressure sensor error
E2	Communication error between hydro box and outdoor unit
H0	Communication error between main control chip and inverter driver chip
E0	Communication error between master hydro module and slave hydro module
Ed	Outdoor unit error
E5	Abnormal power supply
PP	Compressor discharge insufficient superheat protection
P1	Discharge pipe high pressure protection
P2	Suction pipe low pressure protection
P3	Compressor current protection
P4	Discharge temperature protection
PL	Inverter module temperature protection
F1	DC bus voltage error

MUNDO  CLIMA®



C/ NÁPOLES 249 P1
08013 BARCELONA
ESPAÑA / SPAIN
(+34) 93 446 27 80
SAT: (+34) 93 652 53 57

www.mundoclima.com