

MH-30/50-V9

Dehumidifier - Service manual

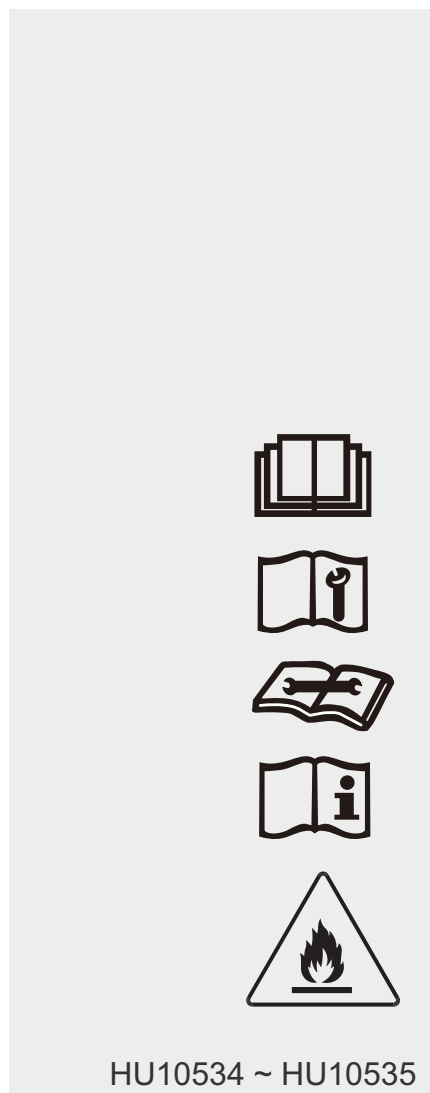
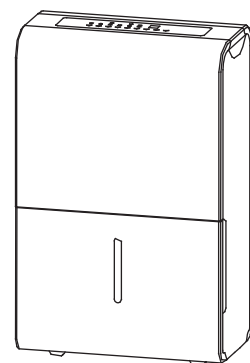

CONTENTS

| | |
|--|----|
| ■ 1. Precaution..... | 1 |
| ■ 1.1 Safety Precaution..... | 1 |
| ■ 1.2 Warning..... | 1 |
| ■ 2. Display | 6 |
| ■ 3. Dimension..... | 8 |
| ■ 4. Refrigerant Cycle Diagram..... | 9 |
| ■ 5. Wiring Diagram..... | 10 |
| ■ 6. Features | 10 |
| ■ 7 .Electronic function..... | 11 |
| ■ 7.1 Electric part assembly condition that use..... | 11 |
| ■ 7.2 PCB working environment | 11 |
| ■ 7.3 Protection function | 11 |
| ■ 7.4 Set humidity operation | 12 |
| ■ 7.5 Continually dehumidify operation..... | 12 |
| ■ 7.6 Smart dehumidifying mode (optional) | 13 |
| ■ 8 Basic test procedure..... | 13 |
| ■ 8.1 Defective compressor | 13 |
| ■ 8.2 Sealed refrigeration system repairs..... | 15 |
| ■ 8.3 Fan motor..... | 17 |
| ■ 8.4 Capacitor..... | 18 |
| ■ 9 Characteristic of temperature sensor | 19 |
| ■ 10 Troubleshooting | 20 |

■ 1. Precaution

■ 1.1 Safety Precaution.

- **To prevent injury to the user or other people and property damage, the following instructions must be followed.**
- **Incorrect operation due to ignoring instruction will cause harm or damage.**
Before service unit, be sure to read this service manual at first.

■ 1.2 Warning

Installation

- **Do not use a defective or underrated circuit breaker. Use this appliance on a dedicated circuit.**
There is risk of fire or electric shock.
- **For electrical work, contact the dealer, seller, a qualified electrician, or an Authorized service center.**
Do not disassemble or repair the product, there is risk of fire or electric shock.
- **Always ground the product.**
There is risk of fire or electric shock.
- **Install the panel and the cover of control box securely.**
There is risk of fire of electric shock.
- **Always install a dedicated circuit and breaker.**
Improper wiring or installation may cause fore or electric shock.
- **Use the correctly rated breaker of fuse.**
There is risk of fire or electric shock.
- **Do not modify or extend the power cable.**
There is risk of fire or electric shock.
- **Do not install, remove, or reinstall the unit by yourself (customer).**
There is risk of fire, electric shock, explosion, or injury.
- **Be caution when unpacking and installing the product.**
Sharp edges could cause injury, be especially careful of the case edges and the fins on the condenser and evaporator.
- **For installation, always contact the dealer or an Authorized service center.**
There is risk of fire, electric shock, explosion, or injury.

- **Do not install the product on a defective installation stand.**

It may cause injury, accident, or damage to the product.

- **Be sure the installation area does not deteriorate with age.**

If the base collapses, the air conditioner could fall with it, causing property damage, product failure, and personal injury.

- **Do not let the air conditioner run for a long time when the humidity is very high and a door or a window is left open.**

Moisture may condense and wet or damage furniture.

- **Take care to ensure that power cable could not be pulled out or damaged during operation.**

There is risk of fire or electric shock.

- **Do not place anything on the power cable.**

There is risk of fire or electric shock.

- **Do not plug or unplug the power supply plug during operation.**

There is risk of fire or electric shock.

- **Do not touch (operation) the product with wet hands.**

There is risk of fire or electric shock.

- **Do not place a heater or other appliance near the power cable.**

There is risk of fire and electric shock.

- **Do not allow water to run into electric parts.**

It may cause fire, failure of the product, or electric shock.

- **Do not store or use flammable gas or combustible near the product.**

There is risk of fire or failure of product.

- **Do not use the product in a tightly closed space for a long time.**

Oxygen deficiency could occur.

- **When flammable gas leaks, turn off the gas and open a window for ventilation before turn the product on.**

Do not use the telephone or turn switches on or off. There is risk of explosion or fire.

- **If strange sounds, or small or smoke comes from product. Turn the breaker off or disconnect the power supply cable.**

There is risk of electric shock or fire.

- **Stop operation and close the window in storm or hurricane. If possible, remove the product from the window before the hurricane arrives.**

There is risk of property damage, failure of product, or electric shock.

- **Do not open the inlet grill of the product during operation. (Do not touch the electrostatic filter, if the unit is so equipped.)**

There is risk of physical injury, electric shock, or product failure.

- **When the product is soaked (flooded or submerged), contact an Authorized service center.**

There is risk of fire or electric shock.

- **Be caution that water could not enter the product.**

There is risk of fire, electric shock, or product damage.

- **Ventilate the product from time to time when operating it together with a stove, etc.**

There is risk of fire or electric shock.

- **Turn the main power off when cleaning or maintaining the product.**

There is risk of electric shock.

- **When the product is not be used for a long time, disconnect the power supply plug or turn off the breaker.**

There is risk of product damage or failure, or unintended operation.

- **Take care to ensure that nobody could step on or fall onto the outdoor unit.**

This could result in personal injury and product damage.

Caution

- **Always check for gas (refrigerant) leakage after installation or repair of product.**

Low refrigerant levels may cause failure of product.

- **Install the drain hose to ensure that water is drained away properly.**

A bad connection may cause water leakage.

- **Keep level even when installing the product.**

To avoid vibration of water leakage

- **Do not install the product where the noise or hot air from the outdoor unit could damage the neighborhoods.**

It may cause a problem for your neighbors.

- **Use two or more people to lift and transport the product.**

Avoid personal injury.

- **Do not install the product where it will be exposed to sea wind (salt spray) directly.**

It may cause corrosion on the product. Corrosion, particularly on the condenser and evaporator fins, could cause product malfunction or inefficient operation.

Operational

- **Do not expose the skin directly to cool air for long periods of time. (Do not sit in the draft).**
This could harm to your health.
- **Do not use the product for special purposes, such as preserving foods, works of art, etc. It is a consumer air conditioner, not a precision refrigerant system**
There is risk of damage or loss of property.
- **Do not block the inlet or outlet of air flow.**
It may cause product failure.
- **Use a soft cloth to clean. Do not use harsh detergents, solvents, etc.**
There is risk of fire, electric shock, or damage to the plastic parts of the product.
- **Do not touch the metal parts of the product when removing the air filter. They are very sharp.**
There is risk of personal injury.
- **Do not step on or put anything on the product. (outdoor units)**
There is risk of personal injury and failure of product.
- **Always insert the filter securely. Clean the filter every two weeks or more often if necessary.**
A dirty filter reduces the efficiency of the air conditioner and could cause product malfunction or damage.
- **Do not insert hands or other object through air inlet or outlet while the product is operated.**
There are sharp and moving parts that could cause personal injury.
- **Do not drink the water drained from the product.**
It is not sanitary could cause serious health issues.
- **Use a firm stool or ladder when cleaning or maintaining the product.**
Be careful and avoid personal injury.
- **Replace the all batteries in the remote control with new ones of the same type. Do not mix old and new batteries or different types of batteries.**
There is risk of fire or explosion.
- **Do not recharge or disassemble the batteries. Do not dispose of batteries in a fire.**
They may burn or explode.
- **If the liquid from the batteries gets onto your skin or clothes, wash it well with clean water. Do not use the remote if the batteries have leaked.**
- **The chemical in batteries could cause burns or other health hazards**

Warning

- Do not use means to accelerate the defrosting process or to clean, other than those recommended by the manufacturer.
- The appliance shall be stored in a room without continuously operating ignition sources (for example: open flames, an operating gas appliance or an operating electric heater).
- Do not pierce or burn.
- Be aware that the refrigerants may not contain an odour.
- Appliance should be installed, operated and stored in a room with a floor area larger than 12 m².
- Compliance with national gas regulations shall be observed.
- Keep ventilation openings clear of obstruction.
- The appliance shall be stored so as to prevent mechanical damage from occurring.
- A warning that the appliance shall be stored in a well-ventilated area where the room size corresponds to the room area as specified for operation.
- Any person who is involved with working on or breaking into a refrigerant circuit should hold a current valid certificate from an industry-accredited assessment authority, which authorises their competence to handle refrigerants safely in accordance with an industry recognised assessment specification.
- Servicing shall only be performed as recommended by the equipment manufacturer. Maintenance and repair requiring the assistance of other skilled personnel shall be carried out under the supervision of the person competent in the use of flammable refrigerants.



Caution: Risk of fire/
flammable materials
(Required for R32/R290 units only)

■ 2. Display

MH-30-V9, MH-50-V9

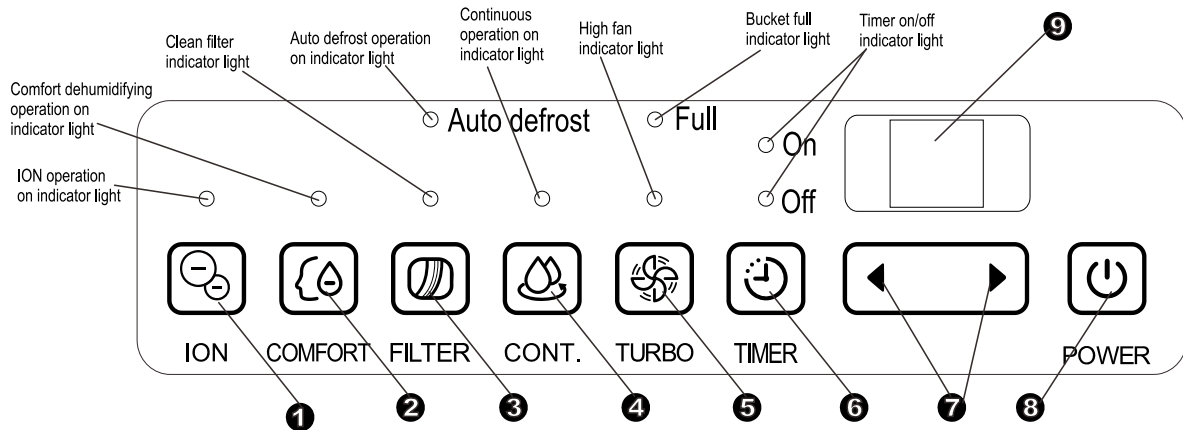

Control pads:

Press to activate the continuous dehumidifying operation

(1) ION Button (reserved)

Press to activate the ionizer. Anions are automatically generated by ionization. The anions deactivate the airborne chemical vapors and dust particles. Press it again to stop the function.

(2) COMFORT pad

Press to activate the comfort dehumidifying operation.

NOTE: On this operation, the unit can not be set humidity level.

(3) FILTER pad

The check filter feature is a reminder to clean the Air Filter for more efficient operation. The Filter light (Clean filter light) will illuminate after 250 hours of operation. To reset after cleaning the filter, press the Filter pad and the light will go off..

(4) CONTINUE pad

Press to activate the continuous dehumidifying operation.

(5) Turbo pad

Control the fan speed. Press to select either High or Normal fan speed. Set the fan control to High for maximum moisture removal. When the humidity has been reduced and quiet operation is preferred, set the fan control to Normal.

(6) Timer pad

Press to initiate the Auto start and Auto stop feature, in conjunction with the ◀ and ▶ key pads

(7) Up/Down pad

- Humidity Set Control Pads

The humidity level can be set within a range of 35%RH(Relative Humidity) to 85%RH(Relative Humidity) in 5% increments. For drier air, press the ◀ pad and set to a lower percent value(%).

For damper air, press the ▶ pad and set a higher percent value(%).

- TIMER Set Control Pads

Use the Up/Down pads to set the Auto start and Auto stop time from 0.0 to 24.

(8) Power pad

Press to turn the dehumidifier on and off.

(9) Display

Shows the set % humidity level from 35% to 85% or auto start/stop time (0~24) while setting, then shows the actual ($\pm 5\%$ accuracy) room % humidity level in a range of 30% RH (Relative Humidity) to 90%RH (Relative Humidity). Error Codes and Protection Codes such as "AS,ES,P2,EC,Eb".

■ 3. Dimension

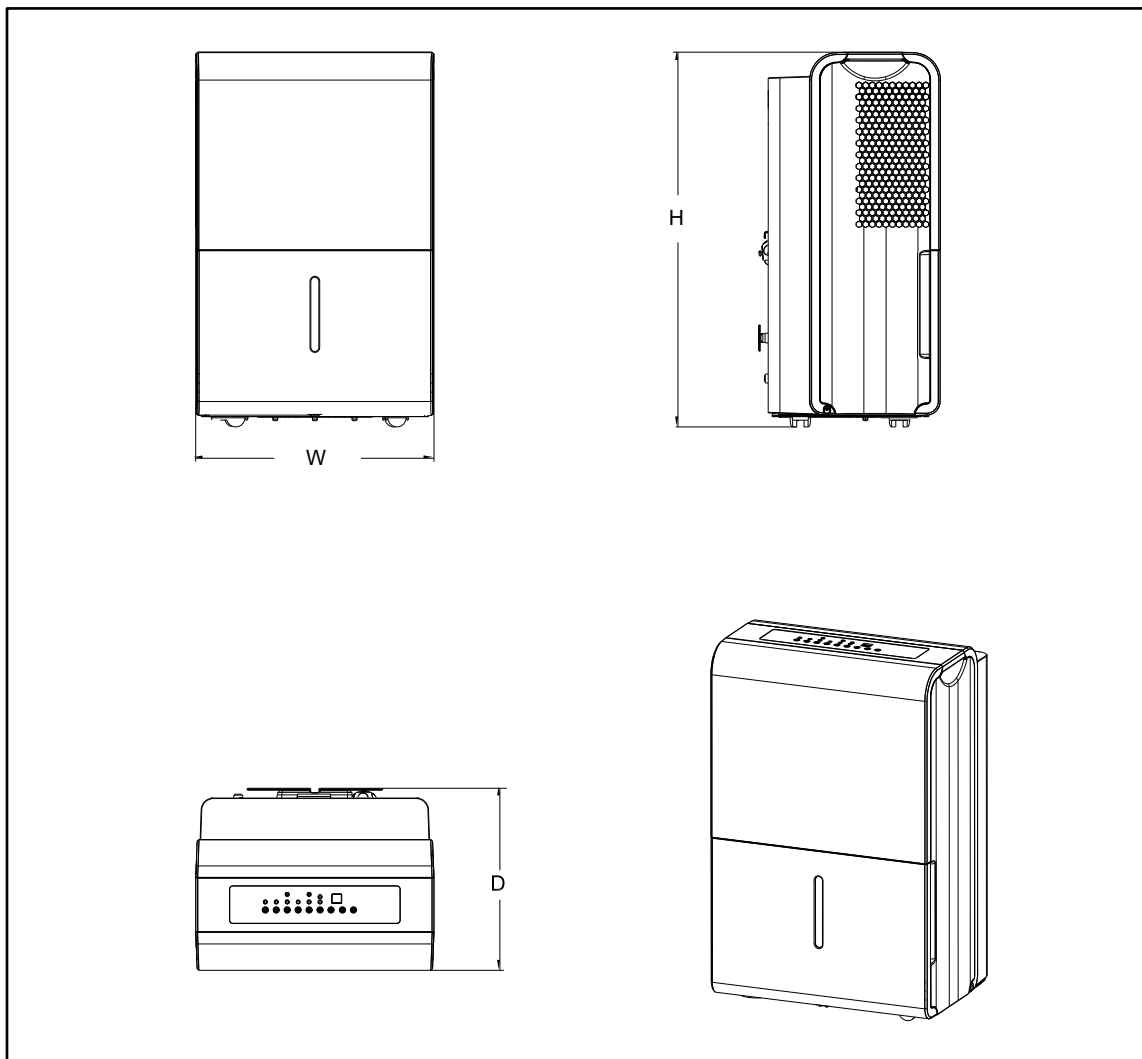

| Model | W(mm) | D(mm) | H(mm) |
|----------|-------|-------|-------|
| MH-30-V9 | 386 | 260 | 500 |
| MH-50-V9 | 392 | 282 | 616 |

■ 4. Refrigerant Cycle Diagram

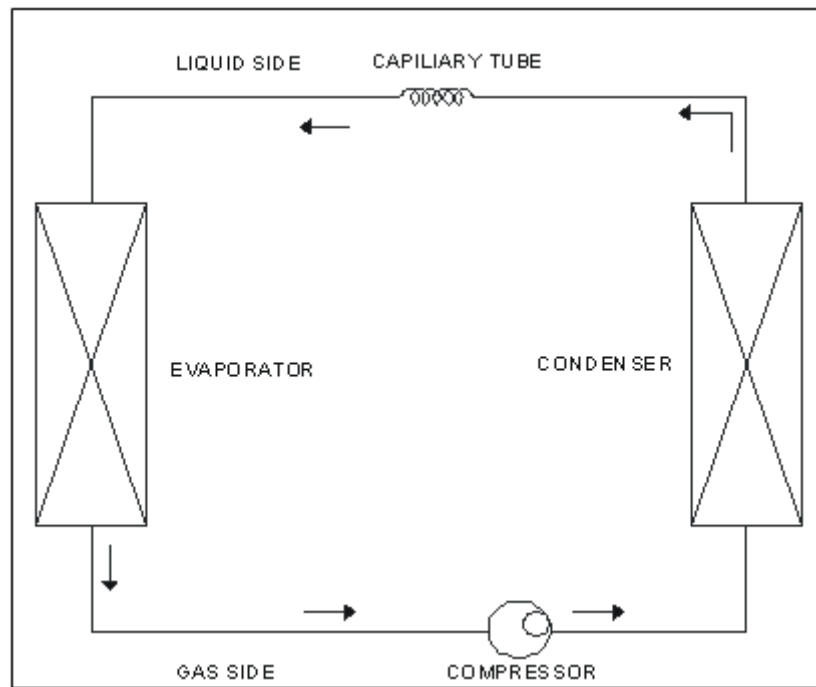

The figure below is a brief description of the important components and their function in what is called the refrigeration system.

■ 5. Wiring Diagram

MH-30-V9, MH-50-V9

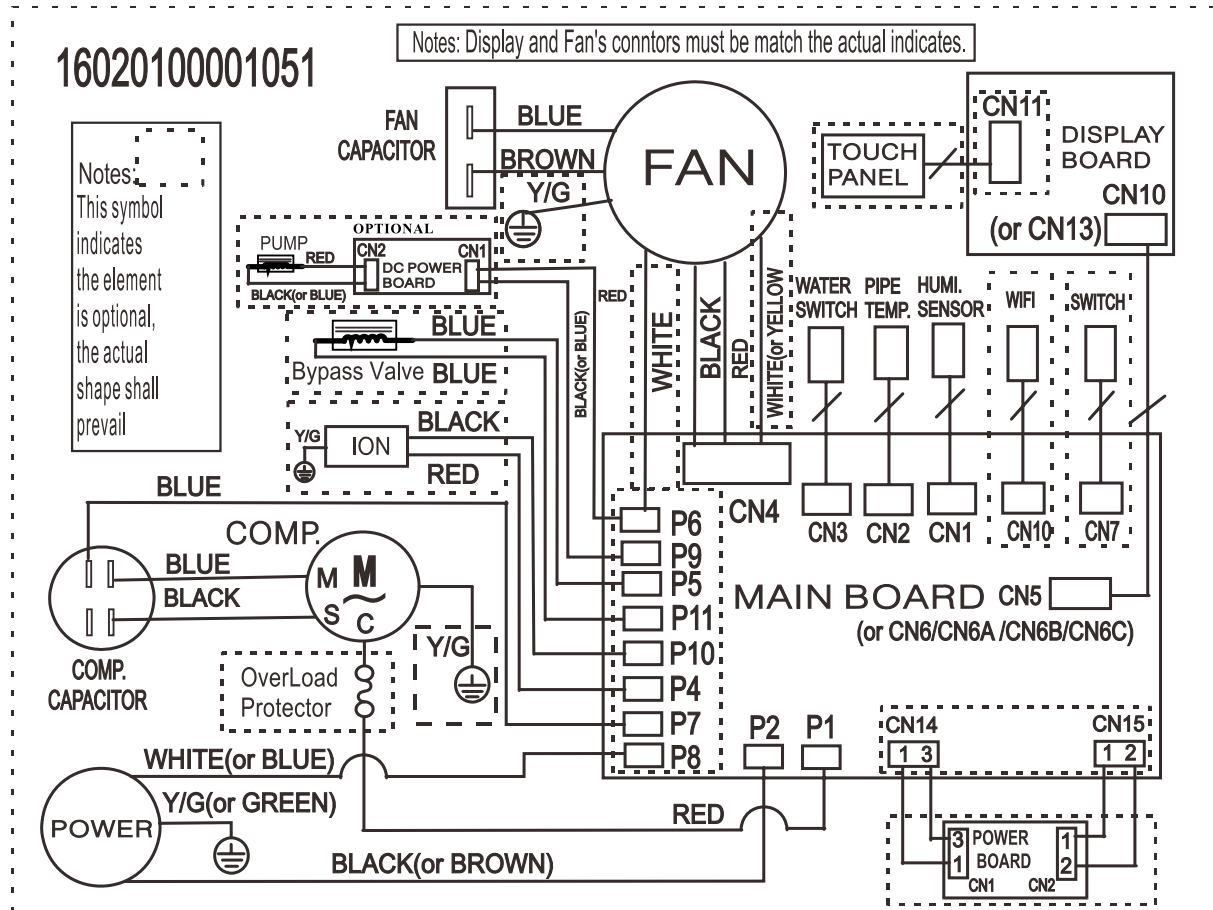

■ 6. Features

- ※ LED display
- ※ Auto restart
- ※ Optional function: Healthy filter
- ※ Continuous dehumidification function
- ※ Water full protection
- ※ Timer function
- ※ Auto defrost
- ※ Omni directional caster
- ※ Self-diagnosis and auto-protection function.
- ※ Refrigerant leakage detection

■ 7 .Electronic function

■ 7.1 Electric part assembly condition that use

- (1).Working environment: 5°C~+35°C;
- (2).The humidity of electric part working environment: 30%RH~90%RH;
- (3).The electric storage working temperature:-20°C~+70°C.

■ 7.2 PCB working environment

- (1).Tolerance of measure indoor side humidity: $\pm 5\%$ RH, the scope of application: 35%RH~85%RH;
- (2).Tolerance of measure evaporator temperature: $\pm 1^\circ\text{C}$, the scope of application: 5°C~+35°C;

■ 7.3 Protection function

- (1).Time delay safety control (3 minutes).

When the compressor is stopped at any modes, it needs 3 minutes delay to restart.

When power on, the AC resumes to the original mode. If on operation mode, the compressor of AC will be restarted for a delay of 3 minutes.

When the compressor is on operation, it will stop again for a delay of more than 3 minutes.

- (2).Water full protection

There is one water level switch on the top of water tank.

(a) There is no water pump, if bucket is full or bucket is not in right position, the water level switch is disconnected for 2 seconds, It shuts down all of load and display error code "P2".

(b) There is a water pump, if bucket is not in right position, the water level switch is disconnected for 2 seconds, It shuts down all of load and display error code "Eb". if bucket is in right position and bucket is full, the water level switch is disconnected for 3 seconds, It shuts down all of load and display error code "P2".

(3).Sensor malfunction:

| | |
|-------------|--|
| LED display | Stand for |
| AS | Humidity sensor error |
| ES | Tube Temperature sensor of the evaporator error |
| P2 | Bucket is full or bucket is removed or not in right position (only available for the unit with no pump) |
| | Bucket is full(only available for the unit with pump) |
| Eb | Bucket is removed or not in right position(only available for the unit with pump) |
| EC | Refrigerant leakage detection |

NOTE:

When more than one error occur, the priority of the code display order is: (Eb—)P2—EC—AS—ES.

■ 7.4 Set humidity operation

(1).In this operation, the range of work is 35%RH-85%RH.

(2).The action of compressor in this operation is like the below graph show:

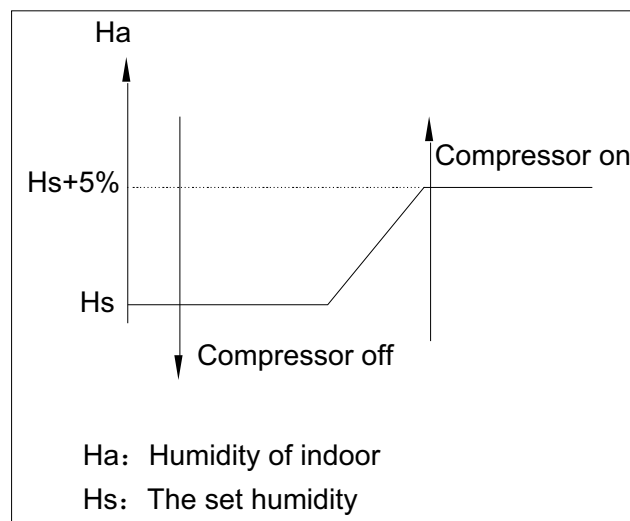

(3). When the power is turned on, the fan is turned on immediately and runs continuously.

(4). If the compressor is turned on ($H_a \geq H_s + 5\%$ and the compressor's three-minute delay protection condition is met), the fan must be running for at least 30 seconds.

(5). After the compressor is started, the set humidity (H_s) and ambient humidity (H_a) should be judged after running for at least 3 minutes to determine whether the compressor is turned on or off, but it should be judged immediately when the set humidity is changed.

(6). After running the compressor for 3 minutes, if $H_a < H_s$, the compressor will be turned off.

(7). When anti-freeze protection, the compressor shuts down immediately. When bucket full protection, the compressor is turned off and the fan is turned off after 30 seconds delay.

(8) In any mode, after the compressor is stopped, it must be delayed for more than 3mins before it can be restarted.

■ 7.5 Continually dehumidify operation

In this operation, the compressor and fan will be working continually unless there is a water full protection or sensor fault protection happened. The setting humidity operation is unapplied.

■ 7.6 Smart dehumidifying mode (optional)

At smart dehumidifying mode, the unit will automatically control room humidity in a comfortable range 45%~55% according to the room temperature. The humidity setting function will be invalid.

If $T < 18^{\circ}\text{C}$, $H_s = 55\%$

If $18^{\circ}\text{C} \leq T \leq 25^{\circ}\text{C}$, $H_s = 50\%$

If $T > 25^{\circ}\text{C}$, $H_s = 45\%$

■ 8 Basic test procedure

■ 8.1 Defective compressor

Compressors are single phase, depending on the model unit. All compressor motors are permanent split capacitor type using only a running capacitor across the start and run terminal.

All compressors are internally spring mounted and externally mounted on rubber isolators.

8.1.1 Compressor wiring test

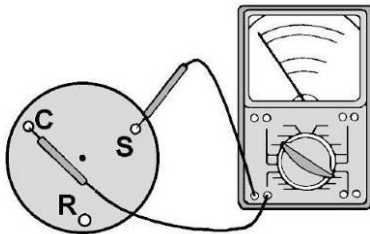

Remove compressor terminal box cover and disconnect wires from terminals. Using an ohmmeter, check continuity across the following:

Terminal "C" and "S" - no continuity

- Open winding - replace compressor.

Terminal "C" and "R" - no continuity

- Open winding - replace compressor.

Terminal "R" and "S" - no continuity

- Open winding - replace compressor.

8.1.2 Ground test

Use an ohmmeter to set on its highest scale. Touch one lead to the compressor body (clean point of

contact as a good connection is a must) and the other probe in turn to each compressor terminal.

If a reading is obtained, the compressor is grounded and must be replaced.

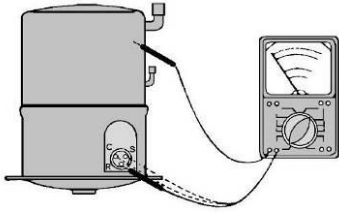

8.1.3 Checking the compressor efficiency

The reason for compressor inefficiency is normally due to broken or damaged suction and/or discharge valves, reducing the ability of the compressor to pump refrigerant gas.

This condition can be checked as follows:

1. Install a piercing valve on the suction and discharge or liquid process tube.
2. Attach gauges to the high and low sides of the system.
3. Start the system and run a “cooling or heating performance test.”

If test shows:

- A. Below normal high side pressure.
- B. Above normal low side pressure.
- C. Low temperature difference across coil.

The compressor valves are faulty - replace the compressor

8.1.4 Terminal overload (external)

Some compressors are equipped with an external overload which is located in the compressor terminal box adjacent to the compressor body .The overload is wired in series with the common motor terminal. The overload senses both major amperage and compressor temperature. High motor temperature or amperage heats the disc causing it to open and break the circuit to the common motor terminal.

Heat generated within the compressor shell is usually due to:

1. High amperage.
2. Low refrigerant charge.
3. Frequent recycling.
4. Dirty condenser.

8.1.5 Terminal overload – Test (compressor external type)

1. Remove overload.
2. Allow time for overload to reset before attempting to test.
3. Apply ohmmeter probes to terminals on overload wires. There should be continuity through

the overload.

8.1.6 Terminal overload (internal)

Some model compressors are equipped with an internal overload. The overload is embedded in the motor windings to sense the winding temperature and/or current draw. The overload is connected in series with the common motor terminal.

Should the internal temperature and/or current draw become excessive; the contacts in the overload will open, turning off the compressor? The overload will automatically reset, but may require several hours before the heat is dissipated.

8.1.7 Checking the internal overload

1. No power to unit, remove the leads from the compressor terminals.
2. Using an ohmmeter, test continuity between terminals C-S and C-R. If not continuous, the compressor overload is open and the compressor must be replaced.

■ 8.2 Sealed refrigeration system repairs

8.2.1 Equipment require

1. Voltmeter
2. Ammeter
3. Ohmmeter
4. E.P.A. Approved Refrigerant Recovery System.
5. Vacuum Pump (capable of 200 microns or less vacuum.)
6. Acetylene Welder
7. Electronic Halogen Leak Detector (G.E. Type H-6 or equivalent.)
8. Accurate refrigerant charge measuring device such as:
 - a. Balance Scales - 1/2 oz. accuracy
 - b. Charging Board - 1/2 oz. accuracy
9. High Pressure Gauge - (0 - 400 lbs.)
10. Low Pressure Gauge - (30 - 150 lbs.)
11. Vacuum Gauge - (0 - 1000 microns)

8.2.2 Equipment must be capable of:

1. Recovery CFC's as low as 5%.
2. Evacuation from both the high side and low side of the system simultaneously.
3. Introducing refrigerant charge into high side of the system.
4. Accurately weighing the refrigerant charge actually introduced into the system.

5. Facilities for flowing nitrogen through refrigeration tubing during all brazing processes.

8.2.3 Hermetic compressor replacement.

The following procedure applies when replacing components in the sealed refrigeration circuit or repairing refrigerant leaks. (Include Compressor, condenser, evaporator, capillary tube, refrigerant leaks, etc.)

1. Recover the refrigerant from the system at the process tube located on the high side of the system by installing a line tap on the process tube. Apply gauge from process tube to EPA approved gauges from process tube to EPA approved recovery system. Recover CFCs in system to at least 5%.
2. Cut the process tube below pinch off on the suction side of the compressor.
3. Connect the line from the nitrogen tank to the suction process tube.
4. Drift dry nitrogen through the system and unsolder the more distant connection first. (Filter drier, high side process tube, etc.)
5. Replace inoperative component, and always install a new filter drier. Drift dry nitrogen through the system when making these connections.
6. Pressurize system to 30 PSIG with proper refrigerant and boost refrigerant pressure to 150 PSIG with dry nitrogen.
7. Leak test complete system with electric halogen leak detector, correcting any leaks found.
8. Reduce the system to zero gauge pressure.
9. Connect vacuum pump to high side and low side of system with deep vacuum hose or copper tubing. (Do not use regular hoses.)
10. Evacuate system to maximum absolute holding pressure of 200 microns or less. NOTE:
This process can be speeded up by use of heat lamps, or by breaking the vacuum with refrigerant or dry nitrogen at 5,000 microns. Pressure system to 5 PSIG and leave in system a minimum of 10 minutes. Recover refrigerant, and proceed with evacuation of a pressure of 200 microns or a minimum of 10%.
11. Break vacuum by charging system from the high side with the correct amount of refrigerant specified. This will prevent boiling the oil out of the crankcase.
NOTE: If the entire charge will not enter the high side, allow the remainder to enter the low side in small increments while operating the unit.
12. Restart unit several times after allowing pressures to stabilize. Pinch off process tubes, cut and solder the ends. Remove pinch off tool, and leak check the process tube ends

8.2.4 Special procedure in the case of compressor motor burnout

1. Recover all refrigerant and oil from the system.

2. Remove compressor, capillary tube and filter drier from the system.
3. Flush evaporator condenser and all connecting tubing with dry nitrogen or equivalent, to remove all contamination from system. Inspect suction and discharge line for carbon deposits. Remove and clean if necessary.
4. Reassemble the system, including new drier strainer and capillary tube.
5. Proceed with processing as outlined under hermetic component replacement.

8.2.5 Rotary compressor special troubleshooting and service

Basically, troubleshooting and servicing rotary compressors is the same as on the reciprocating compressor with only a few exceptions.

1. Because of the spinning motion of the rotary, the mounts are critical. If vibration is present, check the mounts carefully.
2. The electrical terminals on the rotary are in a different order than the reciprocating compressors. The terminal markings are on the cover gasket. Use your wiring diagram to insure correct connections.

8.2.6 Refrigerant charge

1. The refrigerant charge is extremely critical. It must be measured charge carefully - as exact as possible to the nameplate charge.
2. The correct method for charging the rotary is to introduce liquid refrigerant into the high side of the system with the unit off. Then start compressor and enter the balance of the charge, gas only, into the low side.

The introduction of liquid into the low side, without the use of a capillary tube, will cause damage to the discharge valve of the rotary compressor.

NOTE: All inoperative compressors returned to Friedrich must have all lines properly plugged with the plugs from the replacement compressor.

■ 8.3 Fan motor

A single phase permanent split capacitor motor is used to drive the evaporator blower and condenser fan. A self-resetting overload is located inside the motor to protect against high temperature and high amperage conditions.

Fan motor test

1. Determine that capacitor is serviceable.
2. Disconnect fan motor wires from fan speed switch or system switch.
3. Apply "live" test cord probes on black wire and common terminal of capacitor. Motor should

run at high speed.

4. Apply "live" test cord probes on red wire and common terminal of capacitor. Motor should run at low speed.

5. Apply "live" test cord probes on each of the remaining wires from the speed switch or system switch to test intermediate speeds.

■ 8.4 Capacitor

A run capacitor is wired across the auxiliary and main winding of a single phase permanent split capacitor motor such as the compressor. A single capacitor can be used for each motor or a dual rated capacitor can be used for both.

The capacitor's primary function is to reduce the line current while greatly improving the torque characteristics of a motor. The capacitor also reduces the line current to the motor by improving the power factor of the load. Run capacitor hook-up line side of the capacitor is marked with a red dot and is wired to the line side of the circuit

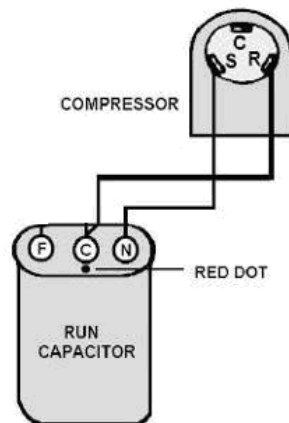

Capacitor test:

1. Remove capacitor from unit.
2. Check for visual damage such as bulges, cracks, or leaks
3. For dual rated, apply an ohmmeter lead to common (C) terminal and the other probe to the compressor (HERM) terminal. A satisfactory capacitor will cause a deflection on the pointer, and then gradually move back to infinity.
4. Reverse the leads of the probe and momentarily touch the capacitor terminals. The deflection of the pointer should be two times that of the first check if the capacitor is good.
5. Repeat steps 3 and 4 to check fan motor capacitor.

NOTE: A shorted capacitor will indicate a low resistance and the pointer will move to the "0" end of the scale and remain there as long as the probes are connected.

An open capacitor will show no movement of the pointer when placed across the terminals of the capacitor.

■ 9 Characteristic of temperature sensor

| Temp. °C | Resistance KΩ | Temp. °C | Resistance KΩ | Temp. °C | Resistance KΩ |
|----------|---------------|----------|---------------|----------|---------------|
| -10 | 62.2756 | 17 | 14.6181 | 44 | 4.3874 |
| -9 | 58.7079 | 18 | 13.918 | 45 | 4.2126 |
| -8 | 56.3694 | 19 | 13.2631 | 46 | 4.0459 |
| -7 | 52.2438 | 20 | 12.6431 | 47 | 3.8867 |
| -6 | 49.3161 | 21 | 12.0561 | 48 | 3.7348 |
| -5 | 46.5725 | 22 | 11.5 | 49 | 3.5896 |
| -4 | 44 | 23 | 10.9731 | 50 | 3.451 |
| -3 | 41.5878 | 24 | 10.4736 | 51 | 3.3185 |
| -2 | 39.8239 | 25 | 10 | 52 | 3.1918 |
| -1 | 37.1988 | 26 | 9.5507 | 53 | 3.0707 |
| 0 | 35.2024 | 27 | 9.1245 | 54 | 2.959 |
| 1 | 33.3269 | 28 | 8.7198 | 55 | 2.8442 |
| 2 | 31.5635 | 29 | 8.3357 | 56 | 2.7382 |
| 3 | 29.9058 | 30 | 7.9708 | 57 | 2.6368 |
| 4 | 28.3459 | 31 | 7.6241 | 58 | 2.5397 |
| 5 | 26.8778 | 32 | 7.2946 | 59 | 2.4468 |
| 6 | 25.4954 | 33 | 6.9814 | 60 | 2.3577 |
| 7 | 24.1932 | 34 | 6.6835 | 61 | 2.2725 |
| 8 | 22.5662 | 35 | 6.4002 | 62 | 2.1907 |
| 9 | 21.8094 | 36 | 6.1306 | 63 | 2.1124 |
| 10 | 20.7184 | 37 | 5.8736 | 64 | 2.0373 |
| 11 | 19.6891 | 38 | 5.6296 | 65 | 1.9653 |
| 12 | 18.7177 | 39 | 5.3969 | 66 | 1.8963 |
| 13 | 17.8005 | 40 | 5.1752 | 67 | 1.83 |
| 14 | 16.9341 | 41 | 4.9639 | 68 | 1.7665 |
| 15 | 16.1156 | 42 | 4.7625 | 69 | 1.7055 |

■ 10 Troubleshooting

In general, possible trouble is classified in three kinds. One is called Starting Failure which is caused from an electrical defect, another is ineffective Air Conditioning caused by a defect in the refrigeration circuit and improper application, and the other is called the Structure Damage.

| Problem | What to check |
|--|--|
| Unit does not start | <ul style="list-style-type: none"> ●Make sure the dehumidifier s plug is pushed completely into the outlet. ●Check the house fuse/circuit breaker box. ●Dehumidifier has reached its pre-set level or bucket is full. ●Water bucket is not in the proper position |
| Dehumidifier does not dry the air as it should | <ul style="list-style-type: none"> ●Did not allow enough time to remove the moisture. ●Make sure there are no curtains, blinds or furniture blocking the front or back of the dehumidifier. ●The humidity control may not be set low enough. ●Check that all doors, windows and other openings are securely closed. ●Room temperature is too low, below 5°C (41°F). ●There is a kerosene heater or something giving off water vapor in the room. |
| The unit makes a loud noise when operating | <ul style="list-style-type: none"> ●The air filter is clogged. ●The unit is tilted instead of upright as it should be. ●The floor surface is not level. |
| Frost appears on the coils | <ul style="list-style-type: none"> ●This is normal. The dehumidifier has Auto defrost feature. |
| Water on floor | <ul style="list-style-type: none"> ●Hose to connector or hose connection may be loose. ●Intend to use the bucket to collect water, but the back drain plug is removed. |
| ES, AS, Eb,,EC or P2 appear in the display | <ul style="list-style-type: none"> ●AS- Humidity sensor error--Unplug the unit and plug it back in. If error repeats, call for service. ●ES- Tube Temperature sensor of the evaporator error-- Unplug the unit and plug it back in. If error repeats, call for service. ●P2/Eb- Bucket is full or bucket is not in right position-- Empty the bucket and replace it in the right position. ●EC- Refrigerant leakage detection-- With this new technology, the display area will appear EC when the unit detects refrigerant leakage ,call for service. |

The pump operation
on light blinks at 1Hz

- Clean the filter of the pump.
- Check the pump hose does not link or block.
- Empty the water of the bucket.

MUNDO  CLIMA®



www.mundoclima.com

C/ NÁPOLES 249 P1
08013 BARCELONA
SPAIN
(+34) 93 446 27 80
SAT: (+34) 93 652 53 57