

Weekly shedule wired remote controller

Installation and Owner's manual

KJR-120G/TF-E



www.mundoclima.com

Thank you very much for purchasing our product.
Before using your unit, please read this manual carefully and
keep it for future reference.

- This manual gives detailed description of the precautions that should be brought to your attention during operation.
- In order to ensure correct service of the wired controller please read this manual carefully before using the unit.
- For convenience of future reference, keep this manual after reading it.
- All the pictures in this manual are for explanation purpose only. Your wire controller may be slightly different .The actual shape shall prevail.
- The design and specifications are subject to change without prior notice for product improvement. Consult with the sales agency or manufacturer for details.



CONTENTS

1. SAFETY PRECAUTION.....	1
2. INSTALLATION ACCESSORY.....	3
3. INSTALLATION METHOD.....	4
4. SPECIFICATION.....	9
5. FEATURE AND FUNCTION OF THE WIRED CONTROLLER.....	10
6. NAME ON THE LCD OF THE WIRE CONTROLLER.....	11
7. NAME OF BUTTON ON THE WIRE CONTROLLER.....	12
8. PREPARATORY OPERATION.....	13
9. OPERATION.....	14
10. TIMER FUNCTIONS.....	19
11. FAULT ALARM HANDING.....	28
12.TECHNICAL INDICATION AND REQUIREMENT	28

I. Safety precautions



The following contents are stated on the product and the operation manual, including usage, precautions against personal harm and property loss, and the methods of using the product correctly and safely. After fully understanding the following contents (identifiers and icons), read the text body and observe the following rules.

■ Identifier description

Identifier	Meaning
 Warning	Means improper handling may lead to personal death or severe injury.
 Caution	Means improper handling may lead to personal injury or property loss.

[Note]: 1. "Harm" means injury, burn and electric shock which need long-term treatment but need no hospitalization
2. "Property loss" means loss of properties and materials.

■ Icon description

Icon	Meaning
	It indicates forbidding. The forbidden subject-matter is indicated in the icon or by images or characters aside.
	It indicates compulsory implementation. The compulsory subject-matter is indicated in the icon or by images or characters aside.

Warning

 Warning	Delegate installation	Please entrust the distributor or professionals to install the unit. The installers must have the relevant know-how. Improper installation performed by the user without permission may cause fire, electric shock, personal injury or water leakage.
---	-----------------------	---

 Usage Warning	Forbid	Do not spray flammable aerosol to the wire controller directly. Otherwise, fire may occur.
	Forbid	Do not operate with wet hands or let water enter the wire controller. Otherwise, electric shock may occur.



NOTE

- ① Do not install the unit in a place vulnerable to leakage of flammable gases. Once flammable gases are leaked and left around the wire controller, fire may occur.
- ② Do not operate with wet hands or let water enter the wire controller. Otherwise, electric shock may occur.
- ③ The wiring should adapt to the wire controller current. Otherwise, electric leakage or heating may occur and result in fire.
- ④ The specified cables shall be applied in the wiring. No external force may be applied to the terminal. Otherwise, wire cut and heating may occur and result in fire.

2. Installation accessory

2.1 Select the installation location

Don't install at the place where cover with heavy oil, vapor or sulfured gas, otherwise, this product would be deformed that would lead to system malfunction.

2.2 Preparation before installation

1. Please confirm that all the following parts you have been supply.

No.	Name	Qty.	Remarks
1	Wire controller	1	_____
2	Installation and owner's manual	1	_____
3	Screws	3	M4X20 (For Mounting on the Wall)
4	Wall plugs	3	For Mounting on the Wall
5	Screws	2	M4X25 (For Mounting on switch box)
6	Plastic screw bars	2	For fixing on switch box
7	Battery	1	
8	The connective wires group	1	Optional

2. Please filed install the following accessory.

No.	Name	Qty.(embedded into wall)	Specification (only for reference)	Remarks
1	Switch box	1	_____	_____
2	Wiring Tube(Insulating Sleeve and Tightening Screw)	1	_____	_____

Precaution of install the wire controller

1. This manual provides the installation method of wire controller. Please refer to the wiring diagram of this installation manual to wire the wire controller with indoor unit.
2. The wire controller working in low voltage loop circuit. Forbid to directly contact the cable of 220V commercial electricity or of 380V high voltage, and don't wire this kind of wire in the said loop; wiring clearance between configured tubes should at the range of 300~500 or above.
3. The Shielded wire of the wire controller must be grounded reliable.
4. Upon finish the wire controller connection, do not employed tramegger to detect the insulation.

3. Installation method

1. Dimensions

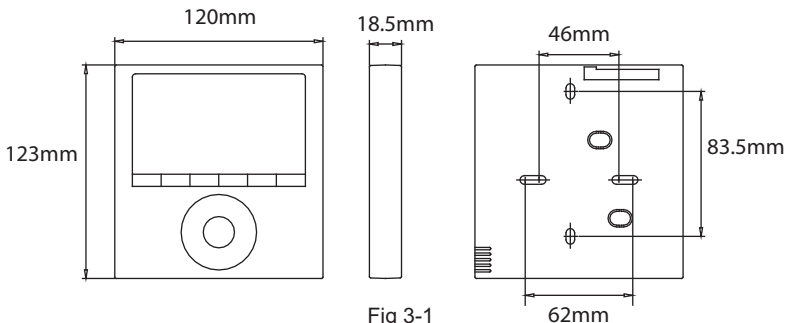

Fig 3-1

2. Remove the upper part of wire controller

- Insert a slot screwdriver into the slots in the lower part of the wire controller (2 places), and remove the upper part of the wire controller. (Fig.3-2)



NOTICE

The PCB is mounted in the upper part of the wire controller. Be careful not to damage the board with the slot screwdriver.

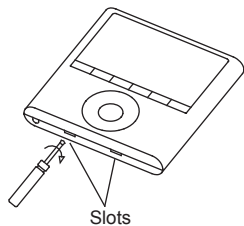

Fig 3-2

3. Fasten the back plate of the wire controller

- For exposed mounting, fasten the back plate on the wall with the 3 screws (M4×20) and plugs. (Fig.3-3)

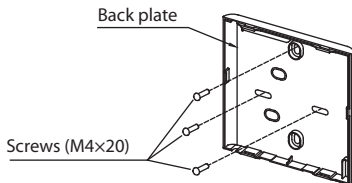

Fig 3-3

- For flush-mounting, fasten the back plate on the switch box with 2 screws (M4x25) and fasten it on the wall with 1 screw (M4x20). (Fig.3-4)

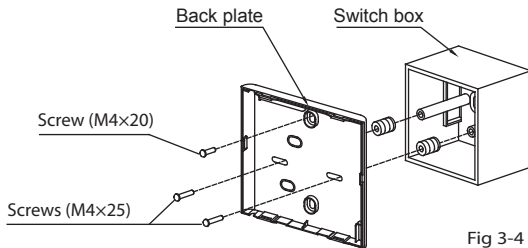

Fig 3-4



NOTICE

Put on a flat surface. Be careful not to distort the back plate of the wire controller by overtightening the mounting screws.

4. Battery installation

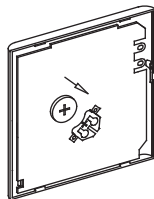

Fig 3-5

- Put the battery into the installation site and make sure the positive side of the battery is in accordance with the positive side of installation site. (See Fig.3-5)
- Please set the time corrected on the first time operation. Batteries in the wire controller can timing under power failure which ensure the time keep right. When the power restores, if the time displayed is not correct, it means the battery is dead and replace the battery.

5. Wire the indoor unit

4 methods

- 1 from the rear;
- 2 from the bottom;
- 3 from the top;
- 4 from the top center.

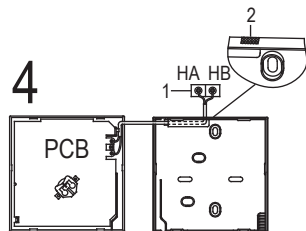
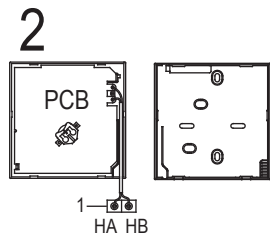
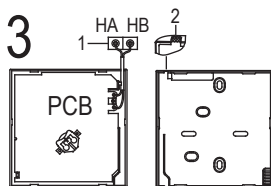
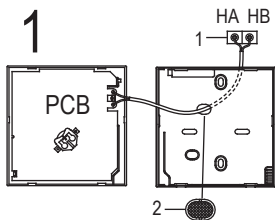

1 indoor unit

2 notch the part for the wiring to pass through with nippers, etc.

Connect the terminals on the remote controller (HA ,HB), and the terminals of the indoor unit (HA ,HB). (HA and HB do not have polarity.)

NOTE: DO NOT allow water to enter the remote control. Use the trap and putty to seal the wires.

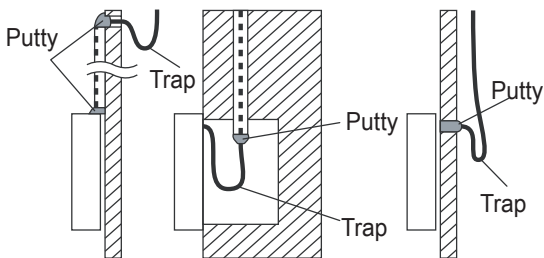

Fig 3-6

6. Reattach the upper part of the wire controller

- After adjusting the upper case and then buckle the upper case; avoid clamping the wiring during installation. (Fig 3-7)

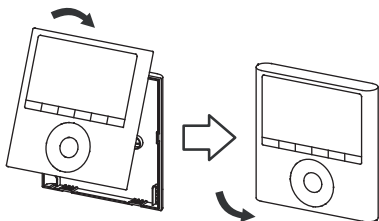

Fig 3-7

All the pictures in this manual are for explanation purpose only. Your wire controller may be slightly different. The actual shape shall prevail.

4. Specification

Input voltage	DC 5V/DC 12V
Ambient temperature	-5~43°C (23~110°F)
Ambient humidity	RH40%~RH90%

Wiring specifications

Wiring type	Size	Total length
Shielded vinyl cord or cable	0.75-1.25mm ²	≤50m

5. Feature and function of the wired controller

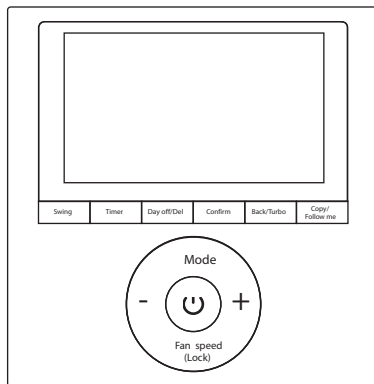

Feature:

LCD display.

Malfunction code display: it can display the error code, helpful for service.

4-way wire layout design, no raised part at backside, more convenient to place the wires and install the device.

Room temperature display.

Weekly Timer.

Function:

Mode: choose Auto-Cool-Dry- Heat -Fan

Fan speed: Auto/Low/Med/High speed

Swing (on some models)

Timer ON/OFF

Temp setting

Weekly timer

Follow me

Child Lock

LCD display

Clock

Faceplate function (on some models)

6. Name on the LCD of the wire controller

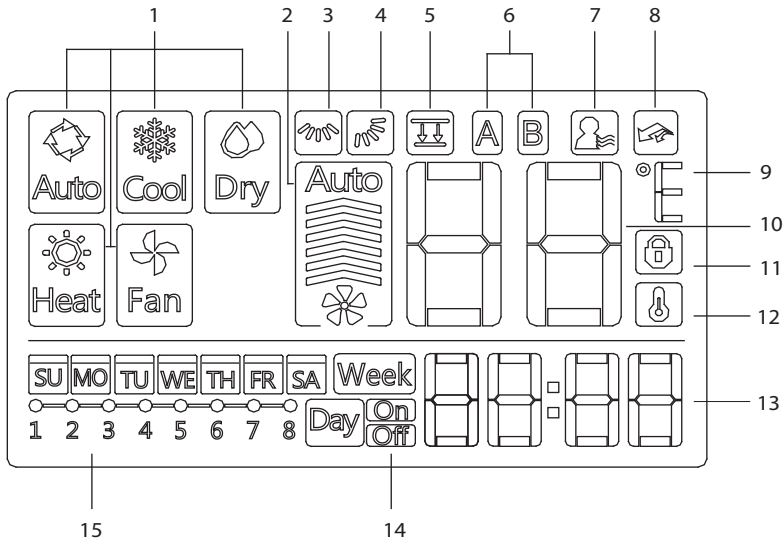

- | | |
|---|--------------------------------|
| 1 Operation mode indication | 8 Turbo function indication |
| 2 Fan speed indication | 9 C° / F° indication |
| 3 Left-right swing indication | 10 Temperature display |
| 4 Up-down swing indication | 11 Lock indication |
| 5 Faceplate function indication | 12 Room temperature indication |
| 6 Main unit and secondary unit indication | 13 Clock display |
| 7 Follow me function indication | 14 On/Off timer |
| | 15 Timer display |

7. Name of the button on the wire controller

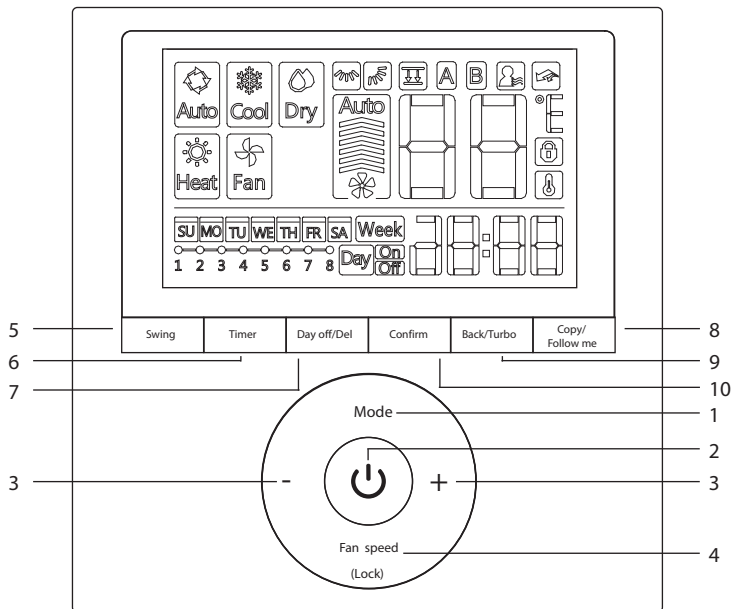

1 MODE button

2 POWER button

3 Adjust button

4 FAN SPEED button

5 SWING Button

6 TIMER button

7 DAY OFF/DEL button

8 COPY/FOLLOW ME button



9 BACK/TURBO button

10 CONFIRM button

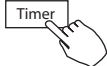

8. Preparatory operation

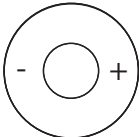
Set the current day and time

- 1  Press the TIMER button for 3 seconds or more.
The timer display will flash.
-

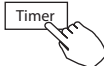
- 2  Press the button "+" or "-" to set the date. The selected date will flash.
- 
-

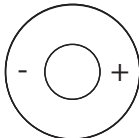
- 3  The date setting is finished and the time setting is prepared after pressing TIMER button or there is no pressing button in 10 seconds.
-

- 4  Press the button "+" or "-" to set the current time.
Press repeatedly to adjust the current time in 1-minute increments.
Press and hold to adjust the current time continuous.
- 
- ex. Monday AM 11:20
-

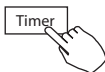
- 5  The setting is done after pressing TIMER button or there is no pressing button in 10 seconds.

9. Operation

To start/stop operation



Press the POWER button.

To set the operation mode

Operation mode setting

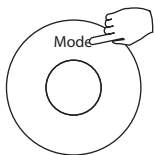

Press the MODE button to set the operation mode.
(Heat function is invalid for cool only type unit)

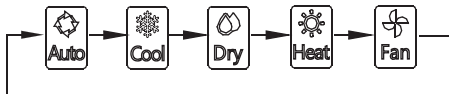

Room temperature setting

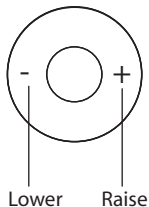

Press the button "+" or "-" to set the room temperature.
Indoor Setting Temperature Range :
17~30°C (62~86°F/62~88°F).

Fan speed setting

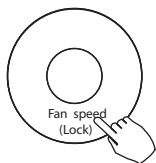

Press the FAN SPEED button to set the fan speed.
(This button is unavailable when in the mode of Auto or Dry)

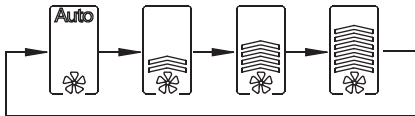

Room temperature sensor selection

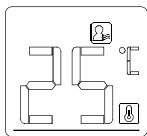
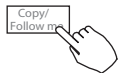

Press the Follow me button to select whether the room temperature is detected at the indoor unit or the wire controller.

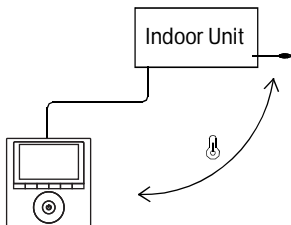

When the Follow me function indication  appears, the room temperature is detected at the wire controller.

Child lock function

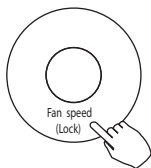

Press the Lock button for 3 seconds to activate the child lock function and lock all buttons on the wire controller.
Press the button again for 3 seconds to deactivate the child lock function.

When the child lock function is activated, the  mark appears.

Keypad tone setting



Press the buttons Swing and Timer simultaneously for 3 seconds to close the keypad tone.
Press the buttons again for 3 seconds to open the keypad tone.

°C & °F scale selection (on some models)



Press the buttons Back and Copy simultaneously for 3 seconds will alternate the temperature display between the °C&°F scale.

Turbo function (on some models)



Press the Turbo button to activate the turbo function.
Press the button again to deactivate the turbo function.

When the turbo function is activated, the  mark appears.

Faceplate function (on some models)

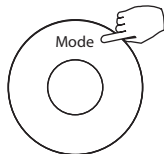

1. When the unit is off, Press the Mode(A/B) button long to activate the faceplate function. The  mark will flash.

The F2 mark appears when the faceplate is adjusted.

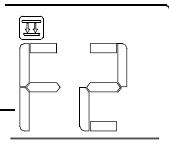

2. Push the Mode(A/B) button to select Unit A or Unit B, the wire controller select in a sequence that goes from (this step do not need to perform if the wire controller is connected with one unit only):

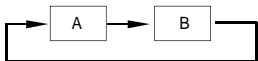

3. Press the button "+" and "-" to control the lift and drop of the faceplate. Pressing the "+" button can stop the faceplate, while it is dropping. Pressing the "-" button can stop the faceplate, while it is lifting.

Left-right airflow swing (on some models)

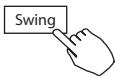

Press the swing button long to activate the auto Left-right swing function. And then the louver would swing automatically. Press it again to stop.

When the auto Left-right swing feature of the louver is activated, the  mark appears. (Not applicable to all the models)

Up-Down airflow direction and swing (on some models)

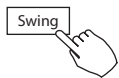

Press the Swing button to start up-down swing function.

Press it again to stop.

When the Up-Down swing function is activated, the  mark appears.
(Not applicable to all the models)

Swing function (For the unit without left & right auto swing function models)

Up-Down airflow direction and swing

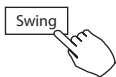

- Use Swing button to adjust the Up-down airflow direction.
 - 1.Press the button every time, the louver swings 6 degrees.
 - 2.Press and hold the button for 2 seconds,it turns into up-down swing mode, press ti again to stop.When the Up-Down swing function is activated, the  mark appears.
(Not applicable to all the models)

- The operation can refer to the following instructions for the unit with four Up-Down louvers can be operated individually.

- 1.Press the Swing button to activate the Up-Down adjusting louver function.

The  mark will flash.(Not applicable to all the models)

- 2.Pressing the button “+” or “-” can select the movement of four louvers.Each time you push the button,the wire controller select in a sequence that goes from:(the icon  means the four louvers move at the same time.)

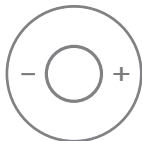
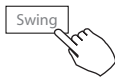
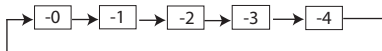

3. And then use Swing button to adjust the Up-Down airflow direction of the selected louver.

10. Timer functions



On timer

Use this timer function to start air conditioner operation. The timer operates and air conditioner operation starts after the time has passed.



Off timer

Use this timer function to stop air conditioner operation. The timer operates and air conditioner operation stops after the time has passed.



On and Off timer

Use this timer function to start and stop air conditioner operation. The timer operates and air conditioner operation starts and stops after the time has passed.



WEEKLY timer

Use this timer function to set operating times for each day of the week.

10.1. Timer ON and/or Timer OFF

To set the On or Off TIMER

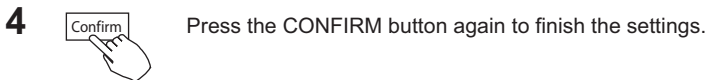
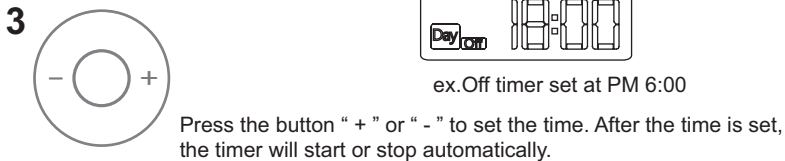
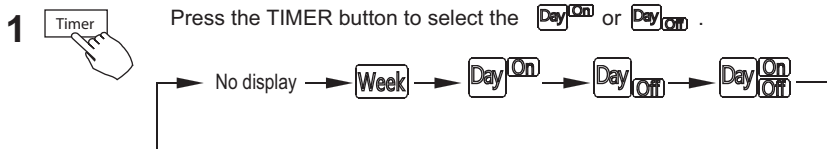

To set the On and Off TIMER

1



Press the TIMER button to select the .

2



Press the CONFIRM button and the Clock display is flashing.

3

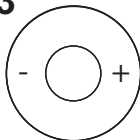

Press the button “+” or “-” to set the time of On timer, and then press the CONFIRM button to confirm the setting.

4

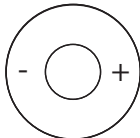

Press the button “+” or “-” to set the time of Off timer.

5



Press the CONFIRM button to finish the settings.

10.2 Weekly timer

1 Weekly timer setting

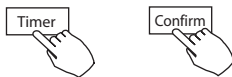

Press the Timer button to select the **Week** ,and then press the Confirm button to confirm.

2 Day of the week setting

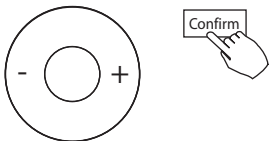

Press the button “+” or “-” to select the day of the week.and then press the Confirm button to confirm the setting.



3 ON timer setting of timer setting 1

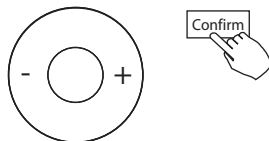

Press the button “+” or “-” to set the time of On timer.and then press the Confirm button to confirm the setting.



ex.Tuesday time scale 1

Up to 4 timer settings can be saved for each day of the week.It is convenient if the WEEKLY TIMER is set according to the user's life style.

4 Off timer setting of timer setting 1

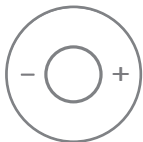

Press the button "+" or "-" to set the time of Off timer,and then press the Confirm button to confirm the setting.

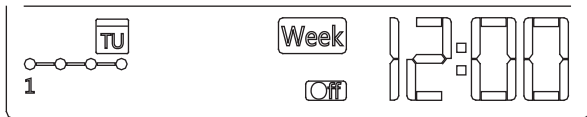

ex.Tuesday time scale 1

5 Different timer settings can be setted by repeating step 3 to 4.

6 Other days in one week can be setted by repeating step 2 to 5.

NOTE: The weekly timer setting can be returned to the previous step by pressing Back button.

The time of timer setting can be delete by pressing Day off botton

The current setting will be restored and withdrawn the weekly timer setting automatically when there is no operation for 30 seconds.

WEEKLY timer operation

To activate WEEKLY TIMER operation



Press the Timer button while **Week** is displayed on the LCD.

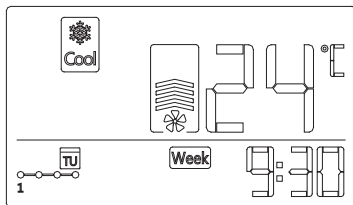

ex.

To deactivate WEEKLY TIMER operation



Press the Timer button while **Week** is disappear from the LCD.

• To turn off the air conditioner during the weekly timer



1. If press the Power button once and quickly , the air conditioner will turn off temporarily. And the air conditioner will turn on automatically until the time of On timer.

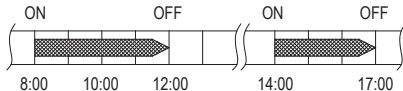

ex. If press the POWER button once and quickly at 10:00, The air conditioner will turn on at 14:00.

2. When press the Power button for 2 seconds , the air conditioner will turn off completely.

To set the DAY OFF (for a holiday)

- 1**  During the weekly timer, press the Confirm button.
-

- 2**  Press the button "+" or "-" to select the day in this week.
-

- 3**  Press the Day off button to set the DAY OFF.

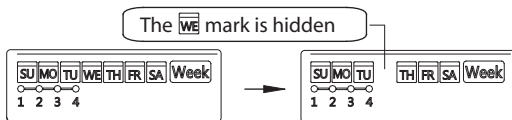

ex.The DAY OFF is set for Wednesday

- 4** The DAY OFF can be set for other days by repeating the steps 2 and 3.
-

- 5**  Press the Back button to back to the weekly timer.
-

To cancel: Follow the same procedures as those for setup.

Notes:

The DAY OFF setting is cancelled automatically after the set day has passed.

DELAY function



During the weekly timer, pressing the Del button once, display "0h".

Press this button twice, display "1h" and wait 3 seconds to confirm.

It means the unit will override 1 hours;

Press this button three times, display "2h" and wait 3 seconds to confirm.

It means the unit will override 2 hours;

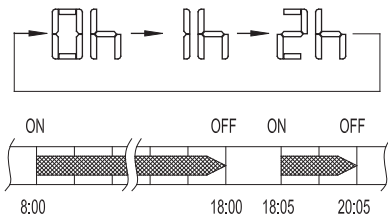

ex. If press the DEL button to select "2h" at 18:05 ,
The air conditioner will delay to turn off at 20:05.

Copy out the setting in one day into the other day.

A reservation made once can be copied to another day of the week.

The whole reservation of the selected day of the week will be copied.

The effective use of the copy mode ensures ease of making reservations.



During the weekly timer, press the Confirm button.

2



Press the button "+" or "-" to select the day to copy from.



Press the Copy button, the letter "CY" will be shown on the LCD.



Press the button "+" or "-" to select the day to copy to.



Press the Copy button to confirm .

The  mark flashes quickly

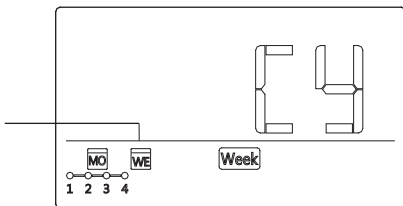

ex. Copy the setting of Monday to Wednesday

6 Other days can be copied by repeating step 4 and 5.



Press the Confirm button to confirm the settings.



Press the Back button to back to the weekly timer.

11. Fault alarm handing

If the system does not properly operate except the above mentioned cases or the above mentioned malfunctions is evident, investigate the system according to the following procedures.

NO.	MALFUNCTION & PROTECTION DEFINE	DISPLAY DIGITAL TUBE
1	Error of communication between wire controler and indoor unit	F0
2	The faceplate is abnormal	F1

Please check the error display of indoor unit and read <<OWNER'S MANUAL>> if other error code appears.

12. Technical indication and requirement

EMC and EMI comply with the CE certification requirements.

Note:

The design and specifications are subject to change without prior notice for product improvement. Consult with the sales agency or manufacturer for details

MUNDO  CLIMA®



www.mundoclima.com

ASK FOR MORE INFORMATION

Phone: (+34) 93 446 27 81

eMail: info@mundoclima.com

TECHNICAL ASSISTANCE

Phone: (+34) 93 652 53 57