

MULTI INVERTER SERIE H6M

Installation and owner's manual

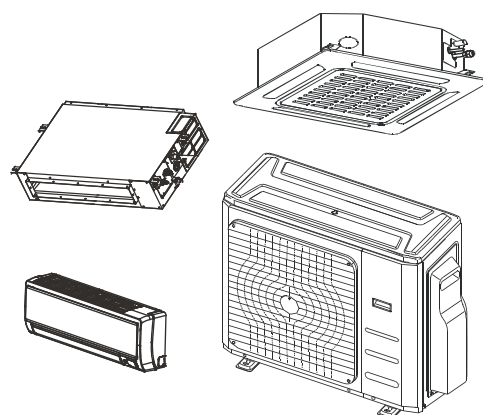

CONTENT

INSTALLATION MANUAL	3
Safety precautions	4
Indoor unit installation	5
Outdoor unit installation	6
Refrigerant pipe connection	8
Electrical installation	10
Drain joint installation	12
Start up and performance testing	12
Function of automatic wiring/piping correction	13
OWNERS MANUAL	14
Safety precautions	15
Description and operating instructions	16
Care and maintenance	20
Troubleshooting	22
Disposal	24
REMOTE CONTROLLER	25

IMPORTANT

Thank you for selecting super quality Air Conditioners. To ensure satisfactory operation for many years to come, this manual should be read carefully before the installation and before using the air conditioner. After reading, store it in a safe place. Please refer to the manual for questions on use or in the event that any irregularities occur. This Air Conditioner should be used for household use.

This unit must be installed by a professional according to RD 795/2010, RD 1027/2007 and RD 238/2013.

WARNING

The power supply must be SINGLE-PHASE (one phase (L) and one neutral (N)) with its grounded power (GND) and its manual switch. Any breach of these specifications involves a breach of the warranty conditions provided by the manufacturer.

NOTE

In line with the company's policy of continual product improvement, the aesthetic and dimensional characteristics, technical data and accessories of this appliance may be changed without notice.

ATTENTION

Read this manual carefully before installing or operating your new air conditioning unit. Make sure to save this manual for future reference.

INSTALLATION MANUAL

Before using your air conditioner, please read this manual carefully and keep it for future reference..

INVERTER SPLIT-TYPE ROOM AIR CONDITIONER

The design and specifications are subject to change without prior notice for product improvement. Consult with the sales agency or manufacturer for details.

Read This Manual:

Inside you will find many helpful hints on how to use and maintain your air conditioner properly.



Just a little preventative care on your part can save you a great deal of time and money over the life of your air conditioner.

You'll find many answers to common problems in the chart of troubleshooting tips. If you review the chart of Troubleshooting Tips first, you may not need to call for service.

1. Safety precautions





- Read the follow SAFETY PRECAUTIONS carefully before installation.
- Electrical work must be installed by a licensed electrician. Be sure to use the correct rating of the power plug and main circuit for the model to be installed.
- Incorrect installation due to ignoring of the instruction will cause harm or damage.

■ **The seriousness is classified by the following indications.**

 WARNING	This symbol indicates the possibility of death or serious injury.
 CAUTION	This symbol indicates the possibility of injury or damage to property.

■ **The items to be followed are classified by the symbols:**

	Symbol with background white denotes item that is PROHIBITED from doing.
---	--

 WARNING	
1) Engage dealer or specialist for installation. If installation done by the user is defective, it will cause water leakage, electrical shock fire.	
2) Install according to this installation instructions strictly. If installation is defective, it will cause water leakage, electrical shock fire.	
3) Use the attached accessories parts and specified parts for installation. otherwise, it will cause the set to fall, water leakage, electrical shock fire.	
4) Install at a strong and firm location which is able to withstand the set's weight. If the strength is not enough or installation is not properly done, the set will drop and cause injury.	
5) For electrical work, follow the local national wiring standard, regulation and this installation instructions. An independent circuit and single outlet must be used. If electrical circuit capacity is not enough or defect found in electrical work, it will cause electrical shock fire.	
6) Use the specified cable and connect tightly and clamp the cable so that no external force will be acted on the terminal. If connection or fixing is not perfect, it will cause heat-up or fire at the connection.	
7) Wiring routing must be properly arranged so that control board cover is fixed properly. If control board cover is not fixed perfectly, it will cause heat-up at connection point of terminal, fire or electrical shock.	
8) When carrying out piping connection, take care not to let air substances other than the specified refrigerant go into refrigeration cycle. Otherwise, it will cause lower capacity, abnormal high pressure in the refrigeration cycle, explosion and injury.	
9) Do not modify the length of the power supply cord or use of extension cord, and do not share the single outlet with other electrical appliances. Otherwise, it will cause fire or electrical shock.	
 CAUTION	
1) This equipment must be earthed and installed with earth leakage current breaker. It may cause electrical shock if grounding is not perfect.	
2) Do not install the unit at place where leakage of flammable gas may occur. In case gas leaks and accumulates at surrounding of the unit, it may cause fire.	
3) Carry out drainage piping as mentioned in installation instructions. If drainage is not perfect, water may enter the room and damage the furniture.	

2. Indoor unit installation

Fit the installation plate

- 1) Fit the installation plate horizontally on structural parts of the wall with spaces around the installation plate.
- 2) If the wall is made of brick, concrete or like, drill five or eight 5mm diameter holes in the wall. Insert Clip anchor for appropriate mounting screws.

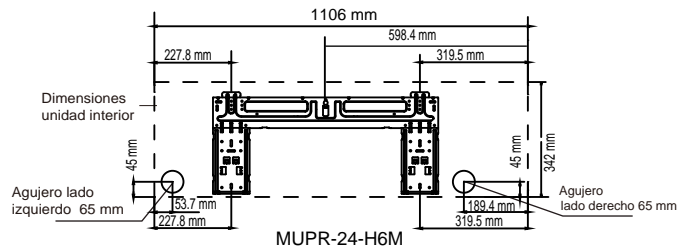
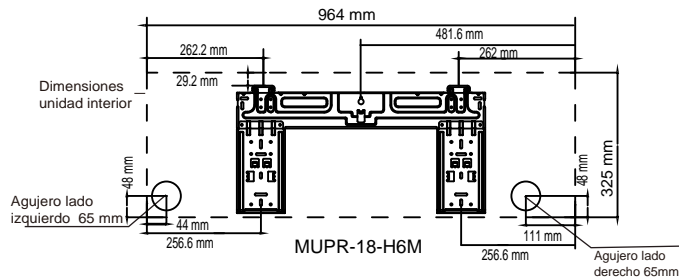
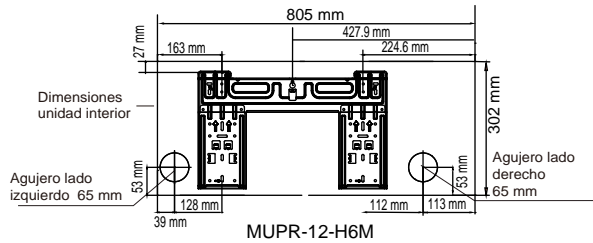
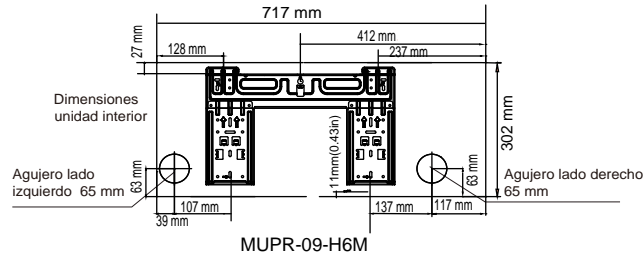

Drill a hole in the wall

1. Determine hole positions according to left and right side of the installation plate. The hole center is obtained by measuring the distance as shown in the diagram above.
2. Drill the piping plate hole with $\phi 65$ mm hole-core drill.
3. Drill the piping hole at either the right or the left and the hole should be slightly slanted to the outdoor side.
4. Always take steps to protect the pipe when drilling metal grid, metal plate or the like.

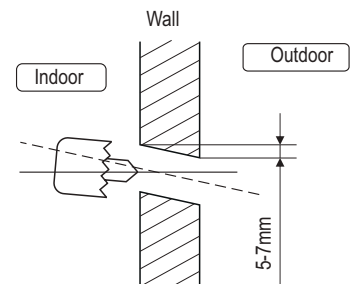

Connective pipe and drainage installation

1. Run the drain hose sloping downward.
Do not install the drain hose as illustrated in Fig.7.
2. When connecting extension drain hose, insulate the connecting part of extension drain hose with a shield pipe, do not let the drain hose slack.

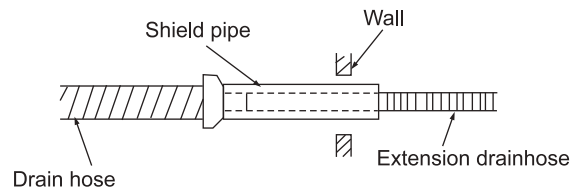
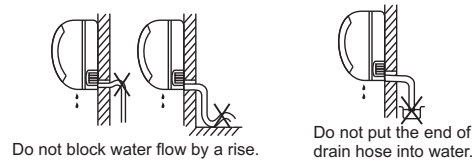

Fig.8

Connective pipe installation

1. For the left-hand and right-hand piping, remove the pipe cover from the side panel.
2. For the rear-right-hand and rear-left-hand piping, install the piping as shown in Fig.10.
3. Fix the end of the connective pipe. (Refer to Tightening Connection in REFRIGERANT PIPING CONNECTION)

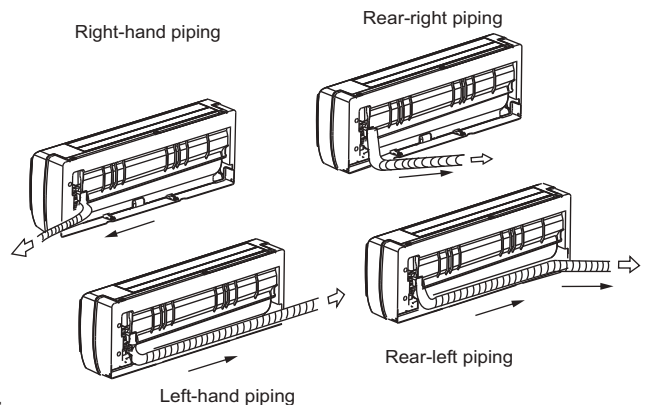

Fig.9

Fig.10

Piping and wrapping

Bundle the tubing, connecting cable, and drain hose with tape securely, evenly as shown in Fig.11.

- Because the condensed water from rear of the indoor unit is gathered in ponding box and is piped out of room. Do not put anything else in the box.

Caution

- Connect the indoor unit first, then the outdoor unit.
- Do not allow the piping to let out from the back of the indoor unit.
- Be careful not to let the drain hose slack.
- Heat insulated both of the auxiliary piping.
- Be sure that the drain hose is located at the lowest side of the bundle. Locating at the upper side can cause drain pan to overflow inside the unit.
- Never intercross nor intertwist the power wire with any other wiring.
- Run the drain hose sloped downward to drain out the condensed water smoothly.

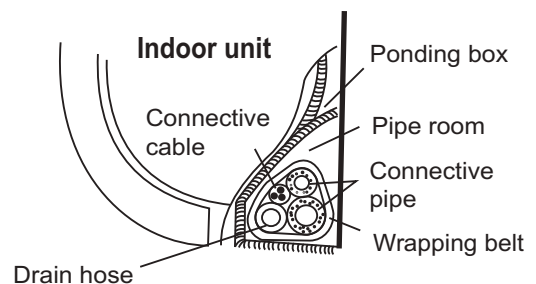
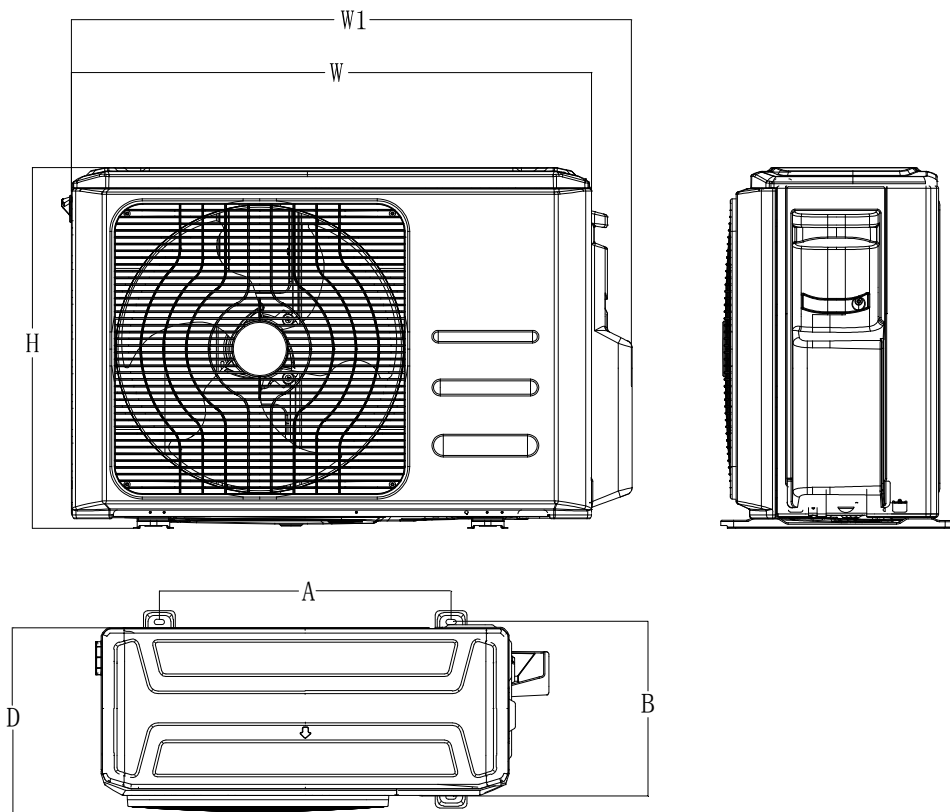

Fig.11

3. Outdoor unit installation

- Install the outdoor unit on a rigid base to prevent increasing noise level and vibration.
- Determine the air outlet direction where the discharged air is not blocked. In the case that the installation place is exposed to strong wind such as a seaside, make sure the fan operating properly by putting the unit lengthwise along the wall or using a dust or shield plates.
- Specially in windy area, install the unit to prevent the admission of wind. If need suspending installation, the installation bracket should accord with technique requirement in the installation bracket diagram.
- The installation wall should be solid brick, concrete or the same intensity construction, or actions to reinforce, damping supporting should be taken. The connection between bracket and wall, bracket and the air conditioner should be firm, stable and reliable.
- Be sure there is no obstacle which block radiating air.

Dimensions



Model	Unit: mm					
	W	D	H	W1	A	B
MUEX-14-H6.2	800	333	554	860	514	340
MUEX-18-H6.2	800	333	554	860	514	340
MUEX-21-H6.3	845	363	702	923	540	350
MUEX-27-H6.3	845	363	702	923	540	350
MUEX-28-H6.4	946	410	810	1034	673	403
MUEX-36-H6.4	946	410	810	1034	673	403
MUEX-42-H6.5	946	410	810	1034	673	403

Space for installation and maintenance

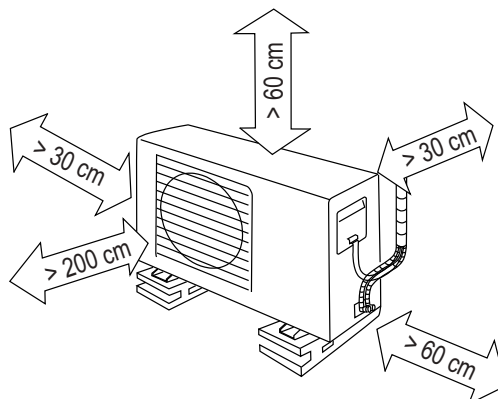

4. Refrigerant pipe connection

Before installing, make sure that the height difference, the length of refrigerant pipe and number of bends between indoor and outdoor units, meet the following specifications.

UNIT		2 x 1 (H6.2)	3 x 1 (H6.3)	4 x 1 (H6.4)	5 x 1 (H6.5)
Max. Length for all rooms (m)		30	45	60	75
Max. Length for one indoor unit (m)		25	30	35	35
Max. height different between indoor and outdoor unit (m)	OU higher than IU	15	15	15	15
	OU lower than IU	15	15	15	15
Max. height different between indoor units (m)		10	10	10	10

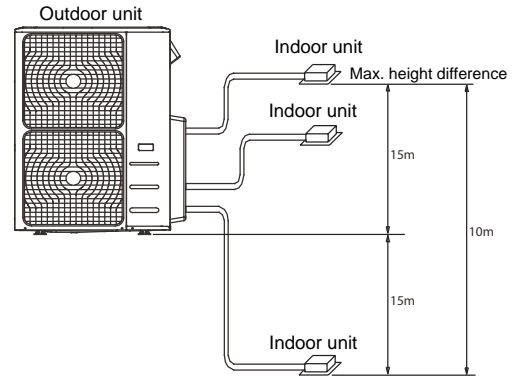

Additional charge (R410A)

UNIT	2 x 1 (H6.2)	3 x 1 (H6.3)	4 x 1 (H6.4)	5 x 1 (H6.5)
Charged until	15m (Total Liquid Length 1/4")	22,5m (Total Liquid Length 1/4")	30m (Total Liquid Length 1/4") 7,5m (Total Liquid Length 3/8")	37,5m (Total Liquid Length 1/4") 7,5m (Total Liquid Length 3/8")
Additional charge (g)	Total Liquid Length 1/4": 15 x (Total length - 15)	Total Liquid Length 1/4": 15 x (Total length - 22,5)	Total Liquid Length 1/4": 15 x (Total length - 30)	Total Liquid Length 1/4": 15 x (Total length - 37,5)
			Total Liquid Length 3/8": 30 x (total length - 7,5)	

1. Flaring work

Main cause for refrigerant leakage is due to defect in the flaring work. Carry out correct flaring work using the following procedure:

A: Cut the pipes and the cable.

1. Use the piping kit accessory or pipes purchased locally.
2. Measure the distance between the indoor and the outdoor unit.
3. Cut the pipes a little longer than the measured distance.
4. Cut the cable 1.5m longer than the pipe length.

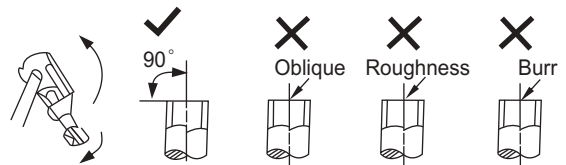

Fig.54

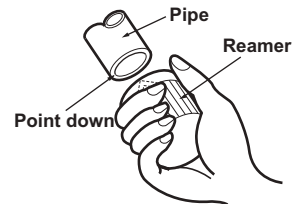

Fig.55

B: Burr removal

1. Completely remove all burrs from the cut cross section of pipe/tube.
2. Put the end of the copper tube/pipe in a downward direction as you remove burrs in order to avoid dropping burrs into the tubing.

C: Putting nut on

Remove flare nuts attached to indoor and outdoor unit, then put them on pipe/tube having completed burr removal. (not possible to put them on after flaring work)

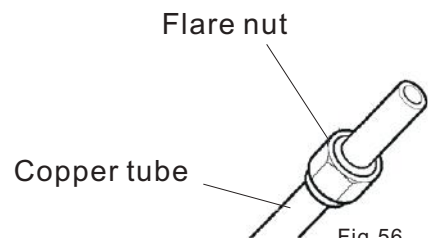

Fig.56

D: Flaring work

Firmly hold copper pipe in a die in the dimension shown in the table below.

Outer diam. (mm)	A(mm)	
	Max.	Min.
φ 6.35	1.3	0.7
φ 9.53	1.6	1.0
φ 12.7	1.8	1.0

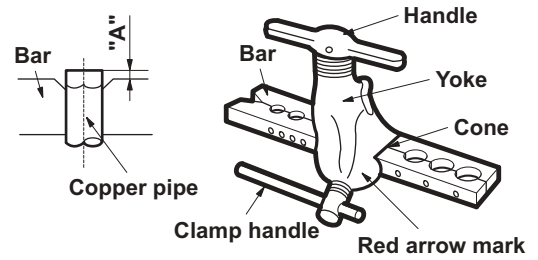

Fig.57

Tightening connection

- Align the center of the pipes.
- Sufficiently tighten the flare nut with fingers, and then tighten it with a spanner and torque wrench as shown in Fig.58 & 59

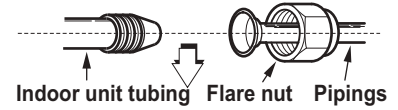

Fig.58

Outer diam.	Tightening torque(N.cm)	Additional tightening torque(N.cm)
φ 6.35	1500 (153kgf.cm)	1600 (163kgf.cm)
φ 9.52	2500 (255kgf.cm)	2600 (265kgf.cm)
φ 12.7	3500 (357kgf.cm)	3600 (367kgf.cm)

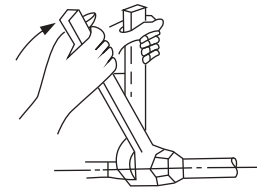

Fig.59

Caution

- Excessive torque can break nut depending on installation conditions.

Air purging

Air and moisture in the refrigerant system have undesirable effects as indicated below:

- Pressure in the system rises.
- Operating current rises.
- Cooling or heating efficiency drops.
- Moisture in the refrigerant circuit may freeze and block capillary tubing.
- Water may lead to corrosion of parts in the refrigeration system.

Therefore, the indoor unit and tubing between the indoor and outdoor unit must be leak tested and evacuated to remove any noncondensables and moisture from the system.

Air purging with vacuum pump

- Preparation
Check that each tube(both liquid and gas side tubes) between the indoor and outdoor units have been properly connected and all wiring for the test run has been completed. Remove the service valve caps from both the gas and the liquid side on the outdoor unit. Note that both the liquid and the gas side service valves on the outdoor unit are kept closed at this stage.
- Pipe length and refrigerant amount:
- When relocate the unit to another place, perform evacuation using vacuum pump.
- Make sure the refrigerant added into the air conditioner is liquid form in any case.

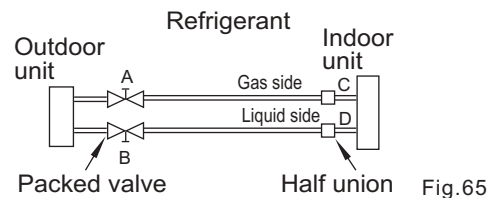

Fig.65

Caution in handling the packed valve

- Open the valve stem until it hits against the stopper. Do not try to open it further.
- Securely tighten the valve stem cap with a spanner or the like.
- Valve stem cap tightening torque (See Tightening torque table in previous page).

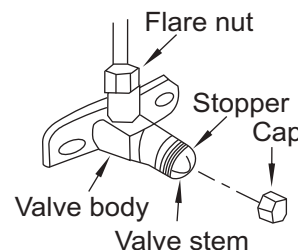

Fig.66

5. Electrical installation

Safety standards

- The supply voltage must be within a range of 90% to 110% of nominal value.
- The thermal circuit breaker and breaker should be 1.5 times the nominal consumption.
- All installation and wiring must comply with local and national average and the installation should be performed by qualified personnel.
- The minimum section of wiring should be as follows according to consumption.

Connect the cable to the outdoor unit

1. Remove the electrical control board cover from the outdoor unit by loosening the screw as shown in figure.
2. Connect the connective cables to the terminals as identified with their respective matched numbers on the terminal block of indoor and outdoor units.
3. Secure the cable onto the control board with the cord clamp.
4. To prevent the ingress of water, from a loop of the connective cable as illustrated in the installation diagram of indoor and outdoor units.
5. Insulate unused cords (conductors) with PVC-tape. Process them so they do not touch any electrical or metal parts.

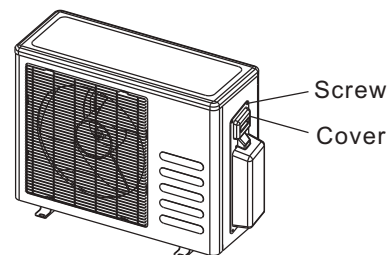

Model	Power Wire	ICP	Differential switch
MUEX-14-H6.2	2 x 2,5 + T mm ²	16 A	2P 30mA
MUEX-18-H6.2	2 x 2,5 + T mm ²	16 A	2P 30mA
MUEX-21-H6.3	2 x 4 + T mm ²	20 A	2P 30mA
MUEX-27-H6.3	2 x 4 + T mm ²	20 A	2P 30mA
MUEX-28-H6.4	2 x 4 + T mm ²	20 A	2P 30mA
MUEX-36-H6.4	2 x 6 + T mm ²	25 A	2P 30mA
MUEX-42-H6.5	2 x 6 + T mm ²	25 A	2P 30mA

Indoor unit connection

a) Wall mounted MUPR-H6M

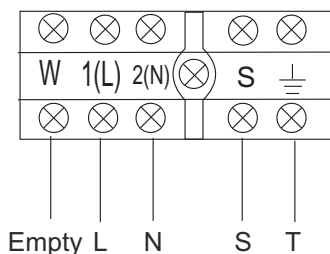

b) Duct MUCR-H6M

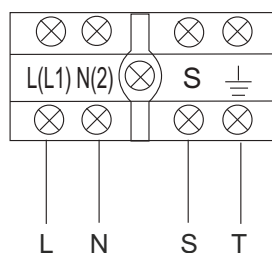

c) Cassette MUCSR-H6M

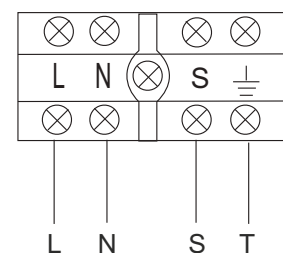

Note:

The wall mounted indoor unit has terminal **W**, that can not be connected.

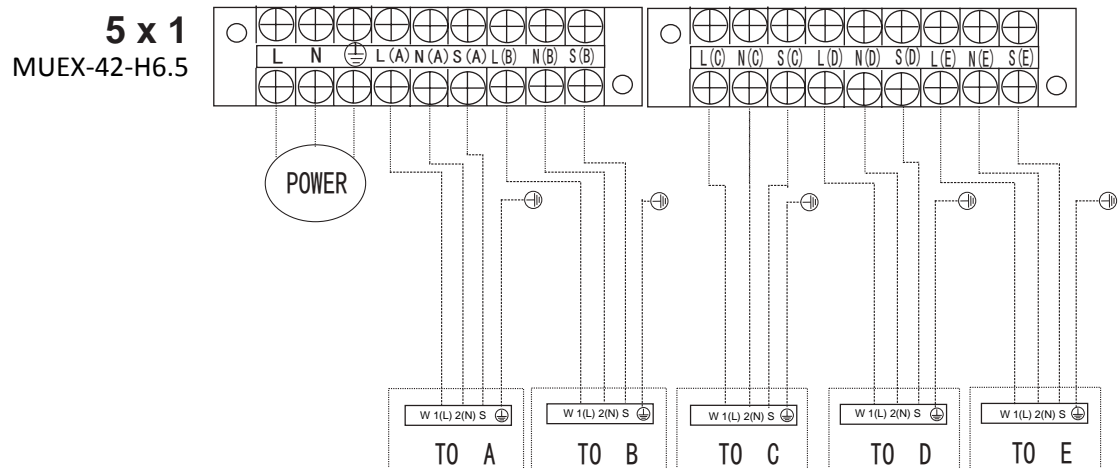
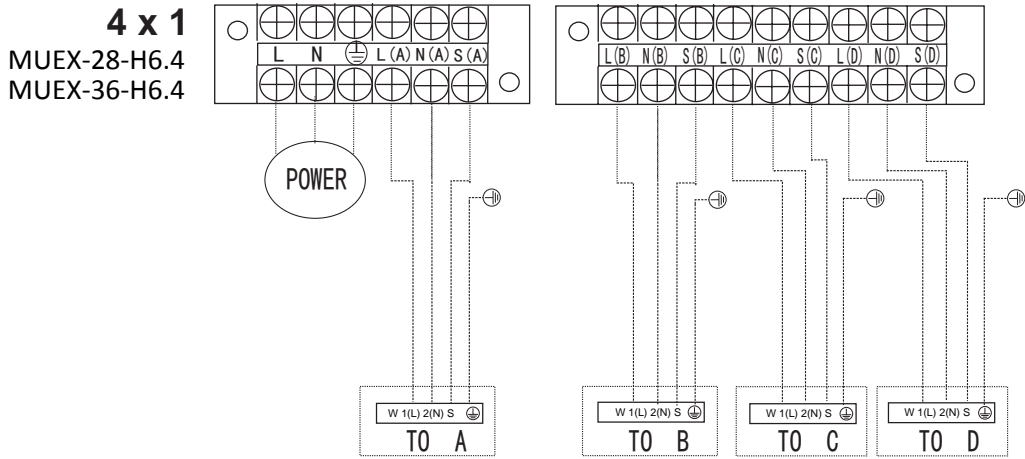
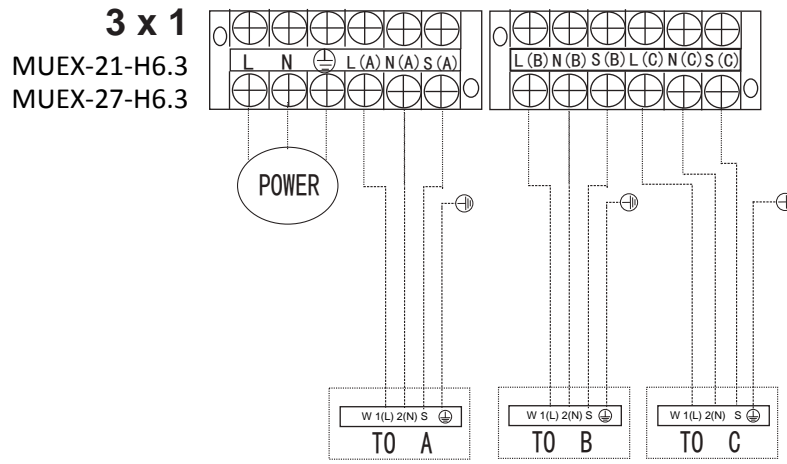
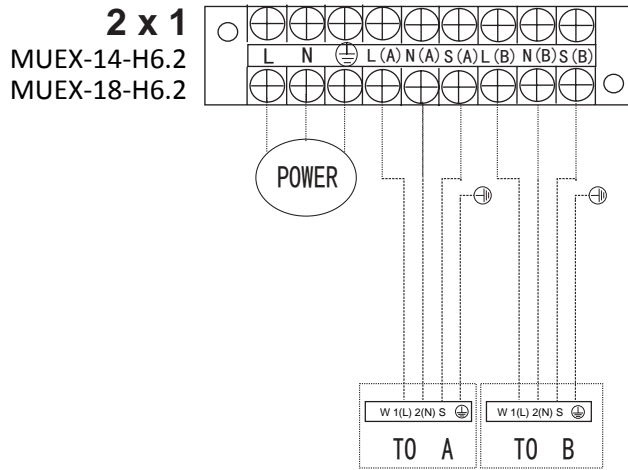

6 . Drain joint installation

Fit the seal into the drain joint, then insert the drain joint into the base pan hole of outdoor unit, rotate 90° to securely assemble them.

Connecting the drain joint with an extension drain hose (Locally purchased), in case of the water draining off the outdoor unit during the heating mode.

NOTE: The drain joint differ from appliance to appliance.

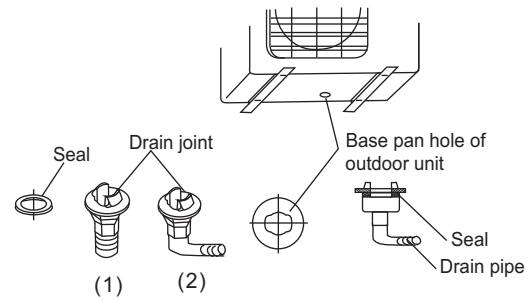

7. Start up and performance testing

Prior check s

- Measure the voltage supply and make sure it is within the specified range.
- Testing must be performed in all modes of operation.
- To operate in cool mode, press the ON/OFF button of the remote controller to place the unit in cooling mode and select a temperature below room temperature.
- To operate in heat mode, press the ON/OFF button of the remote controller to place the unit in heating mode and select a temperature above room temperature.
- You can also check the manual button. This is used when you do not have the remote controller and and is located under the front panel.

8. Function of automatic wiring/piping correction

Automatic Wiring/Piping Correction Function:

More recent models now feature automatic correction of wiring/piping errors. Press the "check switch" on the outdoor unit PCB board for 5 seconds until the LED displays "CE", indicating that this function is working. Approximately 5-10 minutes after the switch is pressed, the "CE" disappears, meaning that the wiring/piping error is corrected and all wiring/piping is properly connected.

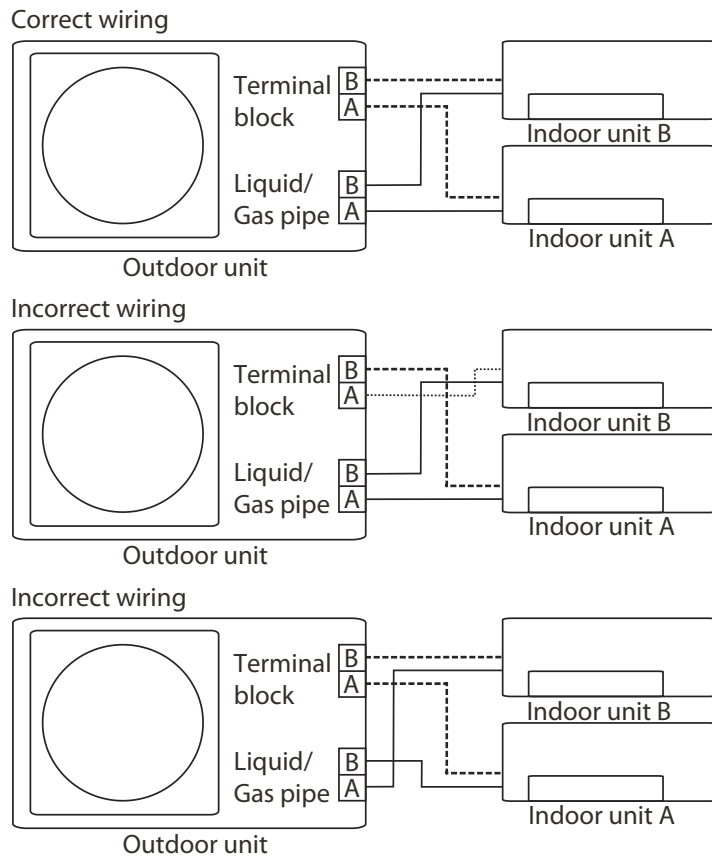
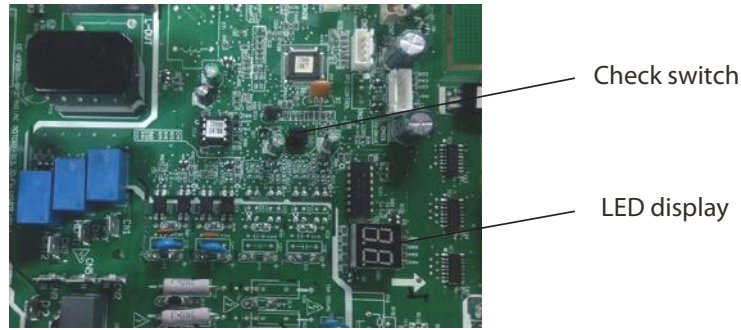

How To Activate This Function:

1. Check that outside temperature is above 5 °C.
(This function does not work when outside temperature is not above 5 °C)
2. Check that the stop valves of the liquid pipe and gas pipe are open.
3. Turn on the breaker and wait at least 2 minutes.
4. Press the check switch on the outdoor PCB board unit LED display "CE".

OWNER'S MANUAL

Before using your air conditioner, please read this manual carefully and keep it for future reference..

INVERTER SPLIT-TYPE ROOM AIR CONDITIONER

The design and specifications are subject to change without prior notice for product improvement. Consult with the sales agency or manufacturer for details.

Read This Manual:

Inside you will find many helpful hints on how to use and maintain your air conditioner properly.



Just a little preventative care on your part can save you a great deal of time and money over the life of your air conditioner.

You'll find many answers to common problems in the chart of troubleshooting tips. If you review the chart of Troubleshooting Tips first, you may not need to call for service.

1. Safety precautions





- Read the follow SAFETY PRECAUTIONS carefully before installation.
- Electrical work must be installed by a licensed electrician. Be sure to use the correct rating of the power plug and main circuit for the model to be installed.
- Incorrect installation due to ignoring of the instruction will cause harm or damage.

■ **The seriousness is classified by the following indications.**

 WARNING	This symbol indicates the possibility of death or serious injury.
 CAUTION	This symbol indicates the possibility of injury or damage to property.

■ **The items to be followed are classified by the symbols:**

	Symbol with background white denotes item that is PROHIBITED from doing.
---	--

 WARNING	
1) Engage dealer or specialist for installation. If installation done by the user is defective, it will cause water leakage, electrical shock fire.	
2) Install according to this installation instructions strictly. If installation is defective, it will cause water leakage, electrical shock fire.	
3) Use the attached accessories parts and specified parts for installation. otherwise, it will cause the set to fall, water leakage, electrical shock fire.	
4) Install at a strong and firm location which is able to withstand the set's weight. If the strength is not enough or installation is not properly done, the set will drop and cause injury.	
5) For electrical work, follow the local national wiring standard, regulation and this installation instructions. An independent circuit and single outlet must be used. If electrical circuit capacity is not enough or defect found in electrical work, it will cause electrical shock fire.	
6) Use the specified cable and connect tightly and clamp the cable so that no external force will be acted on the terminal. If connection or fixing is not perfect, it will cause heat-up or fire at the connection.	
7) Wiring routing must be properly arranged so that control board cover is fixed properly. If control board cover is not fixed perfectly, it will cause heat-up at connection point of terminal, fire or electrical shock.	
8) When carrying out piping connection, take care not to let air substances other than the specified refrigerant go into refrigeration cycle. Otherwise, it will cause lower capacity, abnormal high pressure in the refrigeration cycle, explosion and injury.	
9) Do not modify the length of the power supply cord or use of extension cord, and do not share the single outlet with other electrical appliances. Otherwise, it will cause fire or electrical shock.	
 CAUTION	
1) This equipment must be earthed and installed with earth leakage current breaker. It may cause electrical shock if grounding is not perfect.	
2) Do not install the unit at place where leakage of flammable gas may occur. In case gas leaks and accumulates at surrounding of the unit, it may cause fire.	
3) Carry out drainage piping as mentioned in installation instructions. If drainage is not perfect, water may enter the room and damage the furniture.	

2. Description and operating instructions

Parts

a) Wall mounted MUPR-H6M

Indoor unit

1. Front panel
2. Top air intake
3. Air filter(Inside)
4. Air outlet
5. Horizontal air flow louver
6. Vertical air flow louver(Internal)
7. Display panel
8. LED display window
9. Remote controller
10. Manual control button(Behind the front panel)

Outdoor unit

11. Refrigerant connecting pipe, drain hose and electric wiring
12. Stop valve
13. Air outlet

Display



"00" for 3 seconds when:

- TIMER ON is set
- FRESH, SWING, TURBO, or SILENCE features are turned on

"0F" for 3 seconds when:

- TIMER OFF is set
- FRESH, SWING, TURBO, or SILENCE features are turned off

"cF" when anti-cold air feature is turned on

"dF" when defrosting

"Sc" when unit is self-cleaning

"FP" when freeze protection is turned on

"Wi" when WIFI Control feature is activated
(WIFI module is required CL94382)

In other modes, the unit will display your temperature setting.

In Fan mode, the unit will display the room temperature.

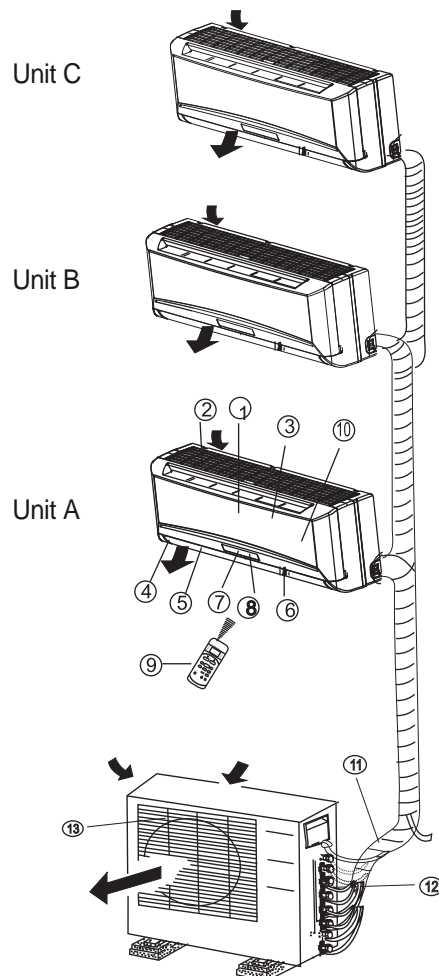

b) Duct MUCR-H6M

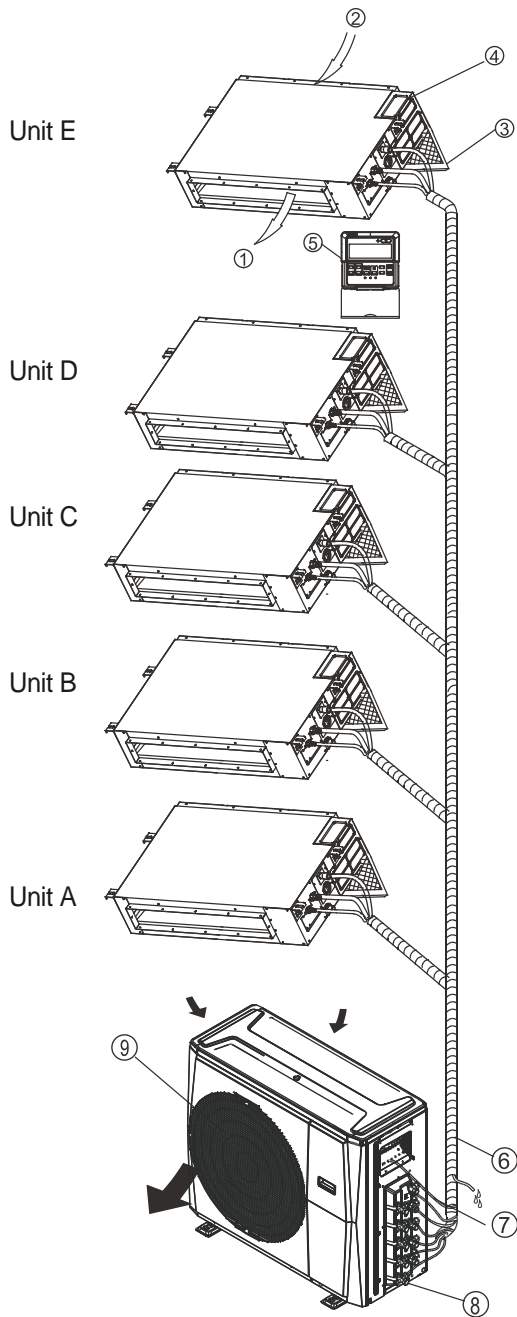

Indoor unit

1. Air outlet
2. Air inlet
3. Air filter
4. Electric control cabinet
5. Wire controller

Outdoor unit

6. Drain hose, refrigerant connecting pipe
7. Connective cable
8. Stop valve
9. Fan hood

c) Cassette MUCSR-H6M

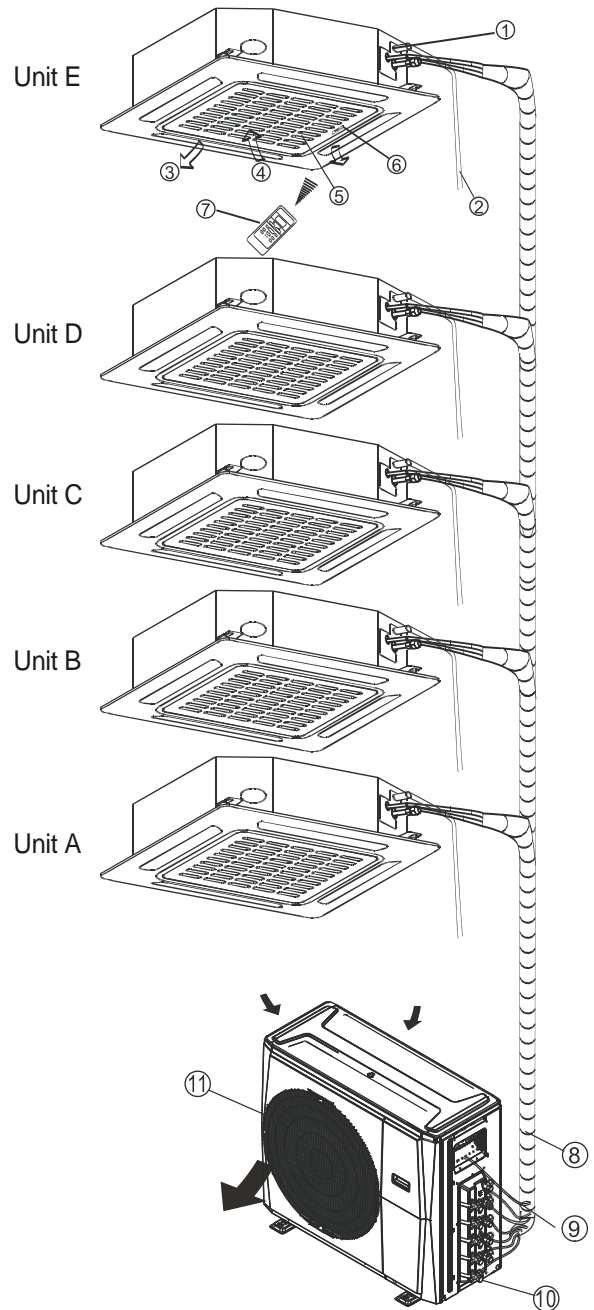

Indoor unit

1. Drain pump (drain water from indoor unit)
2. Drain hose
3. Air outlet
4. Air inlet
5. Air-in grill
6. Display panel
7. Remote controller

Outdoor unit

8. Refrigerant connecting pipe
9. Connective cable
10. Stop valve
11. Fan hood

Operating temperature

Mode	Cooling operation	Heating operation	Drying operation
Room temperature	$\geq 17^{\circ}\text{C}$ (62°F)	$\leq 30^{\circ}\text{C}$ (86°F)	$\geq 17^{\circ}\text{C}$ (62°F)
Outdoor temperature	-15°C ~ 50°C / 5°F ~ 122°F	-15°C ~ 24°C (5 °F ~ 76 °F)	0°C ~ 50°C (32°F ~ 122°F)

NOTE:

- Optimum performance will be achieved within these operating temperatures. If air conditioner is used outside of the above conditions, certain safety protection features might come into operation and cause the unit to function abnormally.
- If the air conditioner operates in a room whose relative humidity is less than 80% the surface of the air conditioner may attract condensation. Please sets the vertical air flow louver to its maximum angle (vertically to the floor), and set HIGH fan mode.

Manual operation

Manual operation can be used temporarily in case you can not find the remote controller or test running purpose or maintenance necessary.

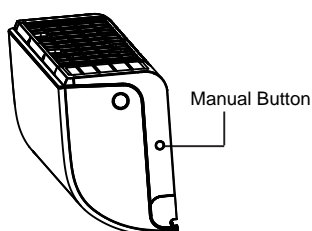

NOTE: The unit must be turned off before operating the manual control button. If the unit is operational, continue pressing the manual control button until the unit is off.

- Open and lift the front panel up will see the manual control button (see Model A)
For some models, the manual control button is located at the bottom of the unit (see Model B).
- One press of the manual control button will lead to the forced AUTO operation. If press the button twice within five seconds, the unit will operate under forced COOL operation.
- Close the panel firmly to its original position.

Airflow direction control

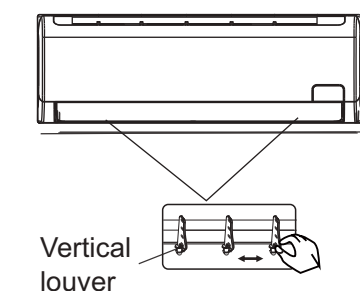
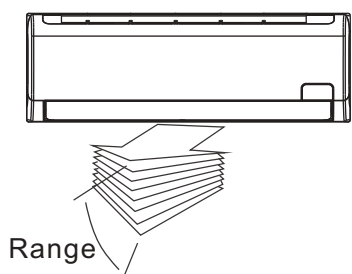

- Adjust the air flow direction properly otherwise it might cause discomfort or cause uneven room temperatures.
- Adjust the horizontal/vertical louver using the remote controller. For some models, the vertical louver can only be adjusted manually.

To set the horizontal/vertical air flow direction

- Perform this function while the unit is in operation.
- Use the remote controller to adjust the air flow direction. The vertical/horizontal louver changes 6 degree in angle for each press, or swing up and down automatically. Please refer to the 'REMOTE CONTROLLER OPERATION MANUAL' for details.

- For some models, the vertical louver can only be adjusted manually. Move the deflector rod manually to adjust the air flow in the direction you prefer.

IMPORTANT: Do not put your fingers into the panel of blower and suction side. The high-speed fan inside may cause danger.

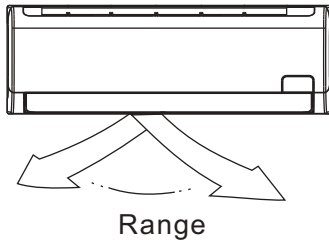

⚠ CAUTION

- Do not operate the air conditioner for long periods with the air flow direction set downward in cooling or dehumidifying mode. Otherwise, condensation may occur on the surface of the horizontal louver causing moisture to drop on to the floor or on furnishings.
- Do not move the horizontal louver manually unless it is necessary. Always use the remote controller.
- When the air conditioner is started immediately after it was stopped, the horizontal louver might not move for approximately 10 seconds.
- Open angle of the horizontal louver should not be set too small, as COOLING or HEATING performance may be impaired due to too restricted air flow area.
- Do not operate unit with horizontal louver in closed position.
- When the air conditioner is connected to power (initial power), the horizontal louver may generate a sound for 10 seconds, this is a normal operation.

How the air conditioner works

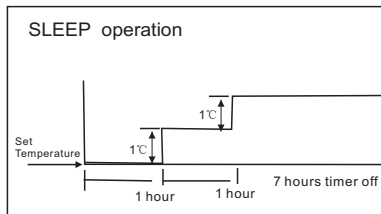

Cooling

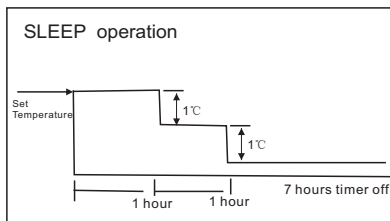

Heating

AUTO operation

- When you set the air conditioner in AUTO mode, it will automatically select cooling, heating (cooling/heating models only), or fan only operation depending on what temperature you have selected and the room temperature.
- The air conditioner will control room temperature automatically round the temperature point set by you.
- If the AUTO mode is uncomfortable, you can select desired conditions manually.

SLEEP operation

- When you push SLEEP button on remote controller during cooling, heating (cooling only type without), or AUTO operation, the air conditioner will automatically increase (cooling) or decrease (heating) 1°C per hour.
- The set temperature will be steady 2 hours later. And the air conditioner will be timer off in 7 hours.
- The fan speed will be automatically controlled.
- This feature can maintain the most comfortable temperature and save more energy for you.

DRYING operation

- The fan speed will be automatically controlled under dry operation.
- During the dry operation, if the room temperature is lower than 10°C, the compressor stops operation and restarts until the room temperature is above 12°C.

3. Care and maintenance

Cleaning the grille, case and remote controller

- Turn the system off before cleaning. To clean, wipe with a soft, dry cloth. Do not use bleach or abrasives.

NOTE: Supply power must be disconnected before cleaning the indoor unit.

⚠ CAUTIONS

- A cloth dampened with cold water may be used on the indoor unit if it is very dirty. Then wipe it with a dry cloth.
- Do not use a chemically treated cloth or duster to clean the unit.
- Do not use benzine, thinner, polishing powder, or similar solvents for cleaning. These may cause the plastic surface to crack or deform.
- Never use water hotter than 40 °C to clean the front panel, it could cause deformation or discoloration.

Cleaning the air filter

A clogged air filter reduces the cooling efficiency of this unit. Please clean the filter once every 2 weeks.

1. Lift the indoor unit panel up to an angle until it stops with a clicking sound.
2. Take hold of the handle of the air filter and lift it up slightly to take it out from the filter holder, then pull it downwards.
3. Remove the **Active Carbon & Dust Filter** from the indoor unit.
 - Clean it once two weeks.
 - Clean it with a vacuum cleaner or water, then dry it up in cool place.
4. Remove the **Air Freshening Filter (Optional filter: Plasma Dust collector/Silver Ion filter /Bio filter / Vitamin C filter)** from its support frame.

(The installation and removing method of the air freshening filter is different depending on the models, see the pictures marked ① and ② on the left.

 - Clean the air freshening filter at least once a month, and replace it every 4-5 months.
 - Clean it with vacuum cleaner, then dry it in cool place.
5. Install the air freshening filter back into position.
6. Insert the upper portion of air filter back into the unit taking care that the left and right edges line up correctly and place filter into position.

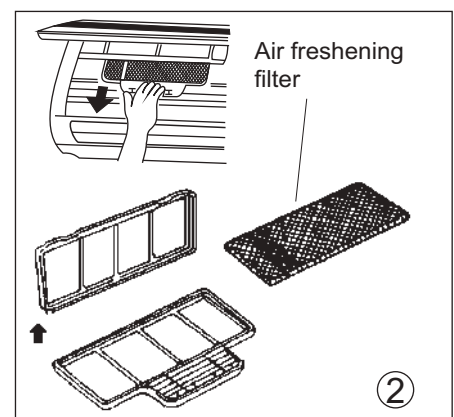
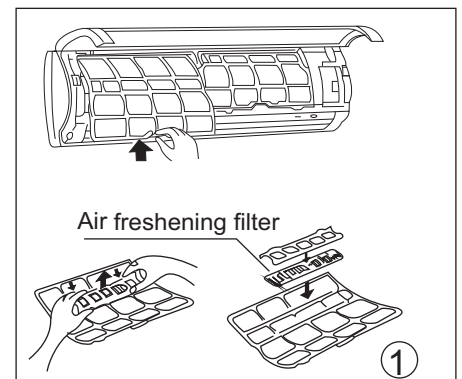
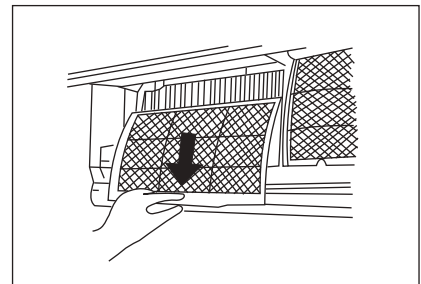
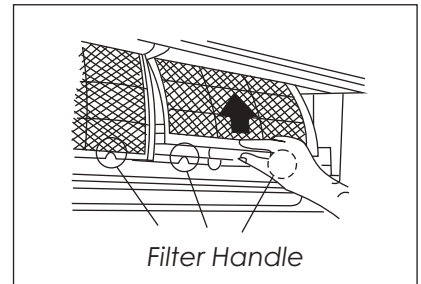
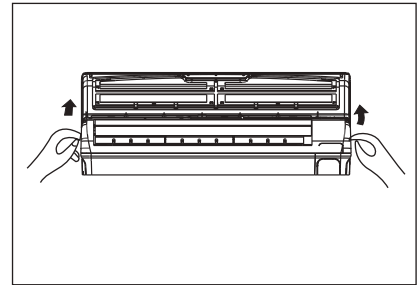

Manitenance

If you plan to idle the unit for a long time, perform the following:

1. Clean the indoor unit and air filter.
2. Select FAN only mode, let the indoor fan run for a while to dry the inside of the unit.
3. Disconnect the power supply and remove battery from the remote control.
4. Check components of the outdoor unit periodically. Contact a local dealer or a customer service centre if the unit requires servicing.

Note: Before you clean the air conditioner, be sure to switch the unit off and disconnect the power supply plug.

When the air conditioner is to be used again:

- Use a dry cloth to wipe off the dust accumulated on rear air intake grille, in order to avoid the dust blowing out from the indoor unit.
- Check that the wiring is not broken off or disconnected.
- Check that the air filter is installed.
- Check if the air outlet or inlet is blocked after the air conditioner has not been used for a long time.

Operation tips

The following events may occur during normal operation.

1. Protection of the air conditioner.

Compressor protection

- The compressor can't restart for 3 minutes after it stops.

Anti-cold air (Cooling and heating models only)

- The unit is designed not to blow cold air on HEAT mode, when the indoor heat exchanger is in one of the following three situations and the set temperature has not been reached.

- A) When heating has just starting.
- B) Defrosting.
- C) Low temperature heating.

- The indoor or outdoor fan stop running when defrosting (Cooling and heating models only).

Defrosting (Cooling and heating models only)

- Frost may be generated on the outdoor unit during heat cycle when outdoor temperature is low and humidity is high resulting in lower heating efficiency of the air conditioner.
- During this condition air conditioner will stop heating operation and start defrosting automatically.
- The time to defrost may vary from 4 to 10 minutes according to the outdoor temperature and the amount of frost buildup on the outdoor unit.

2. A white mist coming out from the indoor unit

- A white mist may generate due to a large temperature difference between air inlet and air outlet on COOL mode in an indoor environment that has a high relative humidity.
- A white mist may generate due to moisture generated from defrosting process when the air conditioner restarts in HEAT mode operation after defrosting.

3. Low noise of the air conditioner

- You may hear a low hissing sound when the compressor is running or has just stopped running. This sound is the sound of the refrigerant flowing or coming to a stop.
- You can also hear a low "squeak" sound when the compressor is running or has just stopped running. This is caused by heat expansion and cold contraction of the plastic parts in the unit when the temperature is changing.
- A noise may be heard due to louver restoring to its original position when power is first turned on.

4. Dust is blown out from the indoor unit.

This is a normal condition when the air conditioner has not been used for a long time or during first use of the unit.

5. Auto-restart function

Power failure during operation will stop the unit completely.

For the unit without Auto-restart feature, when the power restores, the OPERATION indicator on the indoor unit starts flashing. To restart the operation, push the ON/OFF button on the remote controller. For the unit with Auto-restart feature, when the power restores, the unit restarts automatically with all the previous settings preserved by the memory function.

4. Troubleshooting

Stop the air conditioner immediately if one of the following faults occur. Disconnect the power and contact the nearest customer service center.	
Trouble	If the E(0,1.....) or P(0, 1) code appears on the LED(LCD)window, disconnect the power and contact the service people.
	Fuse blows frequently or circuit breaker trips frequently.
	Other objects or water penetrate the air conditioner.
	The remote controller won't work or works abnormally.
	Other abnormal situations.

Malfunctions	Cause	What should be done?
Unit does not start	Power cut	Wait for power to be restored.
	Unit may have become unplugged.	Check that plug is securely in wall receptacle.
	Fuse may have blown.	Replace the fuse.
	Battery in Remote controller may have been exhausted.	Replace the battery.
	The time you have set with timer is incorrect.	Wait or cancel timer setting.
Unit not cooling or heating (Cooling/ heating models only) room very well while air flowing out from the air conditioner	Inappropriate temperature setting.	Set temperature correctly. For detailed method please refer to "Remote controller instruction" section.
	Air filter is blocked.	Clean the air filter.
	Doors or Windows are open.	Close the doors or windows.
	Air inlet or outlet of indoor or outdoor unit has been blocked.	Clear obstructions away first, then restart the unit.
	Compressor 3 minutes protection has been activated.	Wait.

If the trouble has not been corrected, please contact a local dealer or the nearest customer service center. Be sure to inform them of the detailed malfunctions and unit model.

**Notes: Do not attempt to repair the unit yourself.
Always consult an authorised service provider.**

Indoor Unit Error code

Malfunction	Error Code	Timer Lamp	Operation Lamp (flashes)
Indoor EEPROM malfunction	E0	X	1
Communication malfunction between indoor and outdoor units	E1	X	2
Indoor fan speed has been out of control	E3	X	4
Open or short circuit of T1 temperature sensor	E4	X	5
Open or short circuit of T2 temperature sensor	E5	X	6
Water level alarm	EE	X	8
Overcurrent protection (For some units)	F0	O	1
Open or short circuit of T4 temperature sensor	F1	O	2
Open or short circuit of T3 temperature sensor	F2	O	3
Open or short circuit of T5 temperature sensor	F3	O	4
Outdoor EEPROM malfunction (For some units)	F4	O	5
Outdoor fan speed is out of control	F5	O	6
Open or short circuit of T2B temperature sensor (For multi systems)	F6	O	7
Communication error between auto-lifting panel and slim cassette (For slim cassette with auto-lifting panel)	F7	O	8
Auto-lifting panel is faulty (For slim cassette with auto-lifting panel)	F8	O	9
Auto-lifting panel is not closed (For slim cassette with auto-lifting panel)	F9	O	10
IPM module malfunction	P0	☆	1
Over voltage or over low voltage protection	P1	☆	2
Too low ambient temperature protection	P3	☆	4
Error rotor position protection of compressor	P4	☆	5
Mode conflict	P5	☆	6
Low pressure protection of compressor	P6	☆	7
O (on) X(off) ☆(flash at 2Hz)			

5. Disposal

When using this air conditioner in the European countries, the follow information must be followed:

Disposal: Do not dispose this product as unsorted municipal waste. Collection of such waste separately for special treatment is necessary.

It is prohibited to dispose of this appliance in domestic household waste.

For disposal, there are several possibilities:

- A) The municipality has established collection systems, where electronic waste can be disposed of at least free of charge to the user.
- B) When buying a new product, the retailer will take back the old product at least free of charge.
- C) The manufacture will take back the old appliance for disposal at least free of charge to the user.
- D) As old products contain valuable resources, they can be sold to scrap metal dealers.

Wild disposal of waste in forests and landscapes endangers your health when hazardous substances leak into the ground-water and find their way into the food chain.

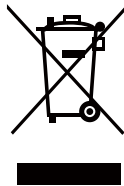

REMOTE CONTROLLER

Please read this Owner's Manual carefully before operation.
Save this manual in a safe place for future reference.

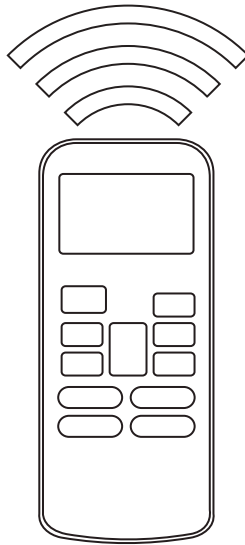

a) Wireless remote controller

SPECIFICATIONS

1

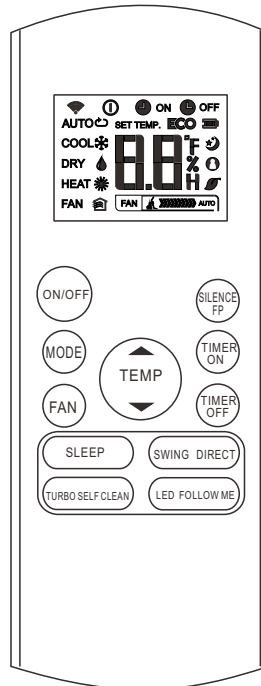

RG57A6/BGEF

Model	RG57A6/BGEF
Rated Voltage	3.0 V (Dry batteries R03/LR03 x 2)
Signal Receiving Range	8 m
Environment	-5°C to 60°C

NOTE:

- Buttons design is based on typical model and might be slightly different from the actual one you purchased, the actual shape shall prevail.
- All the functions described are accomplished by the unit. If the unit has no this feature, there is no corresponding operation happened when press the relative button on the remote controller.
- When there are wide differences between Remote controller Illustration and "Owner's manual" on function description, the description of "Owner's manual" shall prevail.

IMPORTANT NOTE:

- This remote controller is able to set different parameters, it has a function selection. For more information, please contact with Mundoclima after sales service or with your commercial sales.

OPERATION OF BUTTONS 2

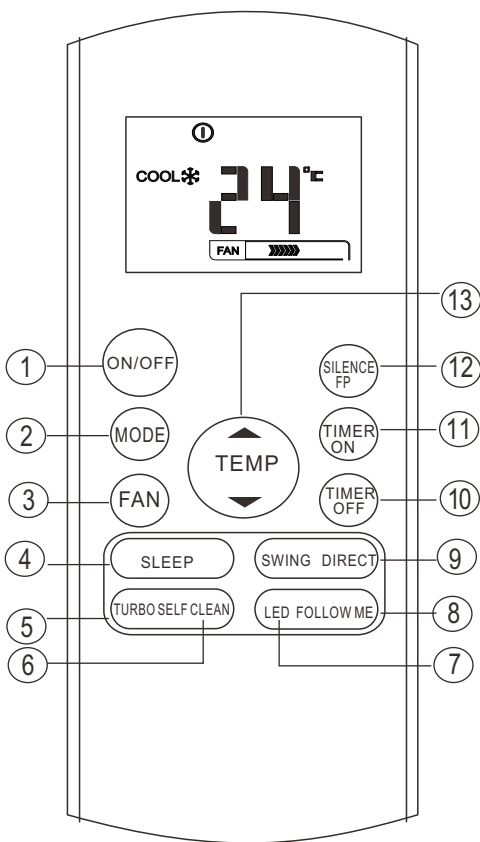

RG57A6/BGEF

- 1 ON/OFF Button**
This button turns the air conditioner ON and OFF.
- 2 MODE Button**
Press this button to modify the air conditioner mode in a sequence of following:
→ AUTO → COOL → DRY → HEAT → FAN
- 3 FAN Button**
Used to select the fan speed in four steps:
→ AUTO → LOW → MED → HIGH

NOTE: You can not switch the fan speed in AUTO or DRY mode.
- 4 SLEEP Button**

 - Active/Disable sleep function. It can maintain the most comfortable temperature and save energy. This function is available on COOL, HEAT or AUTO mode only .
 - For the detail, see "sleep operation" in "OWNER'S MANUAL".

NOTE: While the unit is running under SLEEP mode, it would be cancelled if MODE, FAN SPEED or ON/OFF button is pressed.
- 5 TURBO Button**
Active/Disable Turbo function. Turbo function enables the unit to reach the preset temperature at cooling or heating operation in the shortest time(if the indoor unit does not support this function, there is no corresponding operation happened when pressing this button.)
- 6 SELF CLEAN Button**
Active/Disable Self Clean function
- 7 LED Button**
Disable/Active indoor screen Display. When pushing the button, the indoor screen display is cleared, press it again to light the display.
- 8 FOLLOW ME Button**
Push this button to initiate the Follow Me feature, the remote display is actual temperature at its location. The remote control will send this signal to the air conditioner every 3 minutes interval until press the Follow Me button again. The air conditioner will cancel the Follow Me feature automatically if it does not receive the signal during any 7 minutes interval.

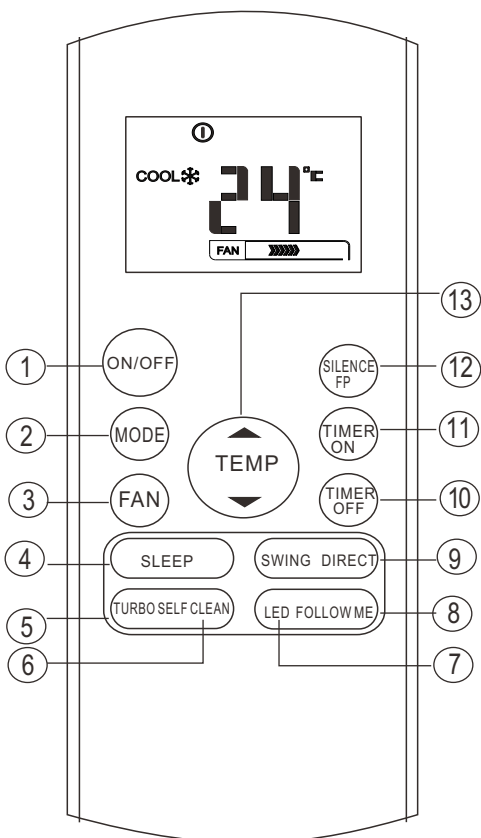

RG57A6/BGEF

9 **SWING Button**

Used to stop or start horizontal louver auto swing feature.

DIRECT Button

Used to change the louver movement and set the desired up/down air flow direction.

The louver changes 6° in angle for each press.

NOTE: When the louver swing or move to a position which would affect the cooling or heating effect of the air conditioner, it would automatically change the swing/moving direction.

10 **TIMER OFF Button**

Press this button to initiate the auto-off time sequence. Each press will increase the auto-timed setting in 30 minutes increments. When the setting time displays 10.0, each press will increase the auto-timed setting 60 minutes increments. To cancel the auto-timed program, simply adjust the auto-off time to 0.0.

11 **TIMER ON Button**

Press this button to initiate the auto-on time sequence. Each press will increase the auto-timed setting in 30 minutes increments. When the setting time displays 10.0, each press will increase the auto-timed setting 60 minutes increments. To cancel the auto-timed program, simply adjust the auto-on time to 0.0.

12 **SILENCE/FP Button**

- Active/Disable SILENCE function. If pushing more than 2 seconds the "FP" function will be activated, pushing more than 2 seconds again to disable.
- When the Silence function is activated, the compressor will operate at low frequency and the indoor unit will bring faint breeze, which will reduce the noise to the lowest level and create a quiet and comfortable room for you. Due to low frequency operation of compressor, it may result in insufficient cooling and heating capacity.
- The 'FP' function can only be activated during the heating operation (only when the setting mode is HEAT). The unit will operate at a setting temperature of 8°C. The display window of indoor unit will display 'FP'. Press the buttons of ON/OFF, SLEEP, FP, MODE, FAN SPEED, UP or DOWN while operating will cancel the 'FP' function.

13 **UP Button (▲)**

Push this button to increase the indoor temperature setting in 1°C increments to 30°C.

DOWN Button (▼)

Push this button to decrease the indoor temperature setting in 1°C increments to 17°C.

NOTE: Temperature control is not available in Fan mode.

INDICATORS ON LCD

3

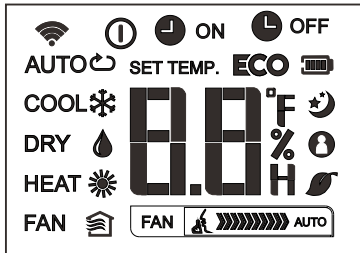

Information are displayed when the remote controller is powered up.

Mode display

AUTO COOL DRY
HEAT FAN

- Displayed when data transmitted.
- Displayed when remote controller is ON.
- Battery display (low battery detection)
- ECO** Not available for this unit

- ON** Displayed when TIMER ON time is set.
- OFF** Displayed when TIMER OFF time is set.
- 88.8** Show set temperature or room temperature, or time under TIMER setting.

- Displayed in Sleep Mode operation.
- Indicated that the air conditioner is operating in Follow me mode
- Not available for this unit
- Not available for this unit

Fan speed indication

- FAN Low speed
- FAN Medium speed
- FAN High speed
- FAN Auto fan speed

Note:

All indicators shown in the figure are for the purpose of clear presentation. But during the actual operation only the relative functional signs are shown on the display window.

HOW TO USE THE BUTTONS

4

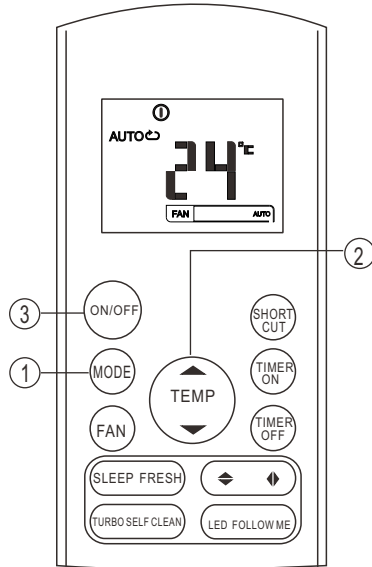

Auto operation

Ensure the unit is plugged in and power is available. The OPERATION indicator on the display panel of the indoor unit starts flashing.

1. Press the **MODE** button to select Auto.
2. Press the **UP/DOWN** button to set the desired temperature. The temperature can be set within a range of 17°C~ 30°C in 1°C increments.
3. Press the **ON/OFF** button to start the air conditioner.

NOTE

1. In the Auto mode, the air conditioner can logically choose the mode of Cooling, Fan, and Heating by sensing the difference between the actual ambient room temperature and the setting temperature on the remote controller.
2. In the Auto mode, you can not switch the fan speed. It has already been automatically controlled.
3. If the Auto mode is not comfortable for you, the desired mode can be selected manually.

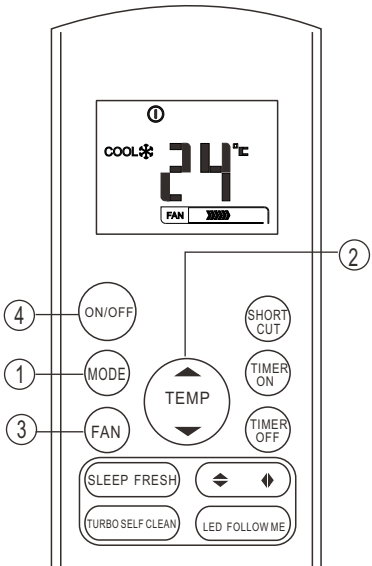

Cooling /Heating/Fan operation

Ensure the unit is plugged in and power is available.

1. Press the **MODE** button to select COOL, HEAT(cooling & heating models only) or FAN mode.
2. Press the **UP/DOWN** buttons to set the desired temperature. The temperature can be set within a range of 17°C~ 30°C in 1°C increments.
3. Press the **FAN** button to select the fan speed in four steps- Auto, Low, Med, or High.
4. Press the **ON/OFF** button to start the air conditioner.

NOTE

In the FAN mode, the setting temperature is not displayed in the remote controller and you are not able to control the room temperature either. In this case, only step 1, 3 and 4 may be performed.

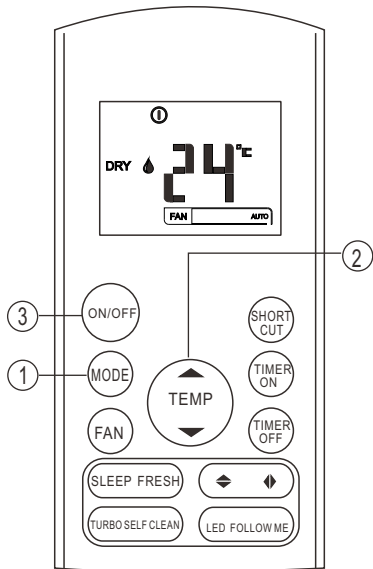

Dehumidifying operation

Ensure the unit is plugged in and power is available. The OPERATION indicator on the display panel of the indoor unit starts flashing.

1. Press the **MODE** button to select DRY mode.
2. Press the **UP/DOWN** buttons to set the desired temperature. The temperature can be set within a range of 17°C~ 30°C in 1°C increments.
3. Press the **ON/OFF** button to start the air conditioner.

NOTE

In the Dehumidifying mode, you can not switch the fan speed. It has already been automatically controlled.

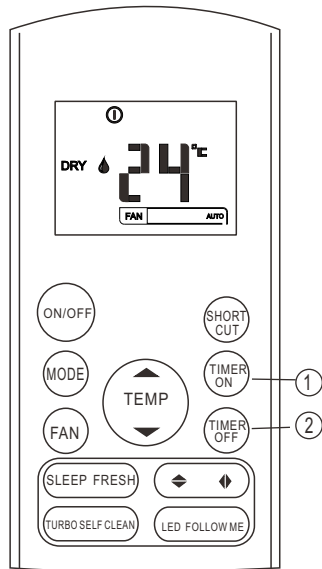

Timer operation

Press the **TIMER ON** button can set the auto-on time of the unit. Press the **TIMER OFF** button can set the auto-off time of the unit.

To set the Auto-on time.

1. Press the **TIMER ON** button. The remote controller shows **TIMER ON**, the last Auto-on setting time and the signal "H" will be shown on the LCD display area. Now it is ready to reset the Auto-on time to **START** the operation.
2. Push the **TIMER ON** button again to set desired Auto-on time. Each time you press the button, the time increases by half an hour between 0 and 10 hours and by one hour between 10 and 24 hours.
3. After setting the **TIMER ON**, there will be a one second delay before the remote controller transmits the signal to the air conditioner. Then, after approximately another 2 seconds, the signal "h" will disappear and the set temperature will re-appear on the LCD display window.

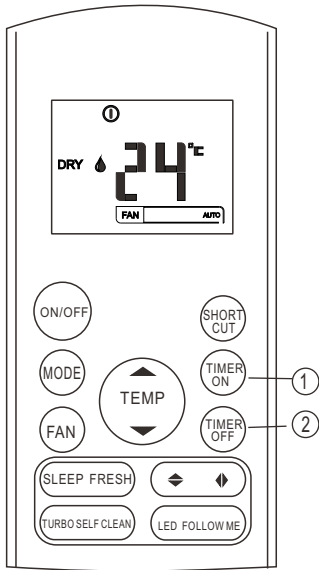

To set the Auto-off time.

1. Press the TIMER OFF button. The remote controller shows TIMER OFF, the last Auto-off setting time and the signal "H" will be shown on the LCD display area. Now it is ready to reset the Auto-off time to stop the operation.
2. Push the TIMER OFF button again to set desired Auto-off time. Each time you press the button, the time increases by half an hour between 0 and 10 hours and by one hour between 10 and 24 hours.
3. After setting the TIMER OFF, there will be a one second delay before the remote controller transmits the signal to the air conditioner. Then, after approximately another 2 seconds, the signal "H" will disappear and the set temperature will re-appear on the LCD display window.

CAUTION

- When you select the timer operation, the remote controller automatically transmits the timer signal to the indoor unit for the specified time. Therefore, keep the remote controller in a location where it can transmit the signal to the indoor unit properly.
- The effective operation time set by the remote controller for the timer function is limited to the following settings: 0.5, 1.0, 1.5, 2.0, 2.5, 3.0, 3.5, 4.0, 4.5, 5.0, 5.5, 6.0, 6.5, 7.0, 7.5, 8.0, 8.5, 9.0, 9.5, 10, 11, 12, 13, 14, 15, 16, 17, 18, 19, 20, 21, 22, 23 and 24.

Example of timer setting

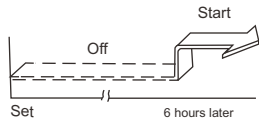

TIMER ON (Auto-on Operation)

The TIMER ON feature is useful when you want the unit to turn on automatically before you return home. The air conditioner will automatically start operating at the set time.

Example:

To start the air conditioner in 6 hours.

1. Press the TIMER ON button, the last setting of starting operation time and the signal "H" will show on the display area.
2. Press the TIMER ON button to display "6.0H" on the TIMER ON display of the remote controller.
3. Wait for 3 seconds and the digital display area will show the temperature again. The "TIMER ON" indicator remains on and this function is activated.

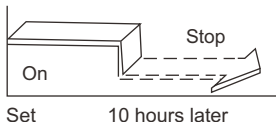

TIMER OFF (Auto-off Operation)

The TIMER OFF feature is useful when you want the unit to turn off automatically after you go to bed. The air conditioner will stop automatically at the set time.

Example:

To stop the air conditioner in 10 hours.

1. Press the TIMER OFF button, the last setting of stopping operation time and the signal "H" will show on the display area.
2. Press the TIMER OFF button to display "10H " on the TIMER OFF display of the remote controller.
3. Wait for 3 seconds and the digital display area will show the temperature again. The "TIMER OFF" indicator remains on and this function is activated.

COMBINED TIMER

(Setting both ON and OFF timers simultaneously)

TIMER OFF → TIMER ON

(On → Stop → Start operation)

This feature is useful when you want to stop the air conditioner after you go to bed, and start it again in the morning when you wake up or when you return home.

Example:

To stop the air conditioner 2 hours after setting and start it again 10 hours after setting.

1. Press the TIMER OFF button.
2. Press the TIMER OFF button again to display 2.0H on the TIMER OFF display.
3. Press the TIMER ON button.
4. Press the TIMER ON button again to display 10H on the TIMER ON display .
5. Wait for 3 seconds and the digital display area will show the temperature again. The "TIMER ON OFF" indicator remains on and this function is activated.

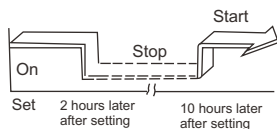
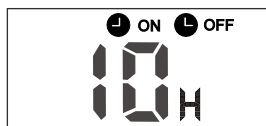

TIMER ON → TIMER OFF

(Off → Start → Stop operation)

This feature is useful when you want to start the air conditioner before you wake up and stop it after you leave the house.

Example:

To start the air conditioner 2 hours after setting, and stop it 5 hours after setting.

1. Press the TIMER ON button.
2. Press the TIMER ON button again to display 2.0H on the TIMER ON display.
3. Press the TIMER OFF button.
4. Press the TIMER OFF button again to display 5.0H on the TIMER OFF display .
5. Wait for 3 seconds and the digital display area will show the temperature again. The "TIMER ON & TIMER OFF" indicator remains on and this function is activated.

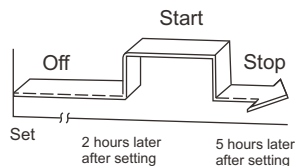

HANDLING THE REMOTE CONTROLLER

5

Location of the remote controller

- Use the remote controller within a distance of 8 meters from the appliance, pointing it towards the receiver. Reception is confirmed by a beep.

⚠ CAUTIONS

- The air conditioner will not operate if curtains, doors or other materials block the signals from the remote controller to the indoor unit.
- Prevent any liquid from falling into the remote controller. Do not expose the remote controller to direct sunlight or heat.
- If the infrared signal receiver on the indoor unit is exposed to direct sunlight, the air conditioner may not function properly. Use curtains to prevent the sunlight from falling on the receiver.
- If other electrical appliances react to the remote controller, either move these appliances or consult your local dealer.
- Do not drop the remote controller. Handle with care.
- Do not place heavy objects on the remote controller, or step on it.

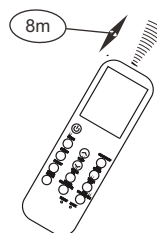
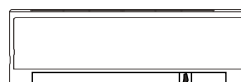

Using the remote controller holder (optional)

- The remote controller can be attached to a wall or pillar by using a remote controller holder(not supplied, purchased separately).
- Before installing the remote controller, check that the air conditioner receives the signals properly.
- Install the remote controller with two screws.
- For installing or removing the remote controller, move it up or down in the holder.

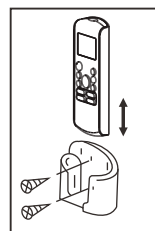

Replacing batteries

The following cases signify exhausted batteries. Replace old batteries with new ones.

- Receiving beep is not emitted when a signal is transmitted.
- Indicator fades away.

The remote controller is powered by two dry batteries (R03/LR03 x 2) housed in the back rear part and protected by a cover.

- (1) Remove the cover in the rear part of the remote controller.
- (2) Remove the old batteries and insert the new batteries, placing the (+) and (-) ends correctly
- (3) Install the cover back on.

NOTE: When the batteries are removed, the remote controller erases all programming. After inserting new batteries, the remote controller must be reprogrammed.

⚠ CAUTIONS

- Do not mix old and new batteries or batteries of different types.
- Do not leave the batteries in the remote controller if they are not going to be used for 2 or 3 months.
- Do not dispose batteries as unsorted municipal waste. Collection of such waste separately for special treatment is necessary.

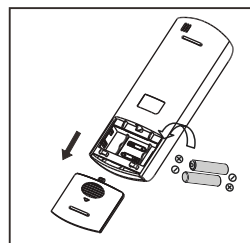



b) Wired remote controller



I. Safety precautions

The following contents are stated on the product and the operation manual, including usage, precautions against personal harm and property loss, and the methods of using the product correctly and safely. After fully understanding the following contents (identifiers and icons), read the text body and observe the following rules.

■ Identifier description

Identifier	Meaning
 Warning	Means improper handling may lead to personal death or severe injury.
 Caution	Means improper handling may lead to personal injury or property loss.
<p>[Note]: 1. "Harm" means injury, burn and electric shock which need long-term treatment but need no hospitalization</p> <p>2. "Property loss" means loss of properties and materials.</p>	

■ Icon description

Icon	Meaning
	It indicates forbidding. The forbidden subject-matter is indicated in the icon or by images or characters aside.
	It indicates compulsory implementation. The compulsory subject-matter is indicated in the icon or by images or characters aside.

Warning

 Warning	Delegate installation	Please entrust the distributor or professionals to install the unit. The installers must have the relevant know-how. Improper installation performed by the user without permission may cause fire, electric, shock, personal injury or water leakage.
---	-----------------------	--

 Usage Warning	Forbid	Do not spray flammable aerosol to the wire controller directly. Otherwise, fire may occur.
	Forbid	Do not operate with wet hands or let water enter the wire controller. Otherwise, electric shock may occur.

-
-  **NOTE**
-
- ① Do not install the unit in a place vulnerable to leakage of flammable gases. Once flammable gases are leaked and left around the wire controller, fire may occur.
 - ② Do not operate with wet hands or let water enter the wire controller. Otherwise, electric shock may occur.
 - ③ The wiring should adapt to the wire controller current. Otherwise, electric leakage or heating may occur and result in fire.
 - ④ The specified cables shall be applied in the wiring. No external force may be applied to the terminal. Otherwise, wire cut and heating may occur and result in fire.
-

2. Installation accessory

2.1 Select the installation location

Don't install at the place where cover with heavy oil, vapor or sulfureted gas, otherwise, this product would be deformed that would lead to system malfunction.

2.2 Preparation before installation

1. Please confirm that all the following parts you have been supply.

No.	Name	Qty.	Remarks
1	Wire controller	1	_____
2	Installation and owner's manual	1	_____
3	Screws	3	M4X20 (For Mounting on the Wall)
4	Wall plugs	3	For Mounting on the Wall
5	Screws	2	M4X25 (For Mounting on switch box)
6	Plastic screw bars	2	For fixing on switch box
7	Battery	1	
8	The connective wires group	1	Optional

2. Please filed install the following accessory.

No.	Name	Qty.(embeded into wall)	Specification (only for reference)	Remarks
1	Switch box	1	_____	_____
2	Wiring Tube(Insulating Sleeve and Tightening Screw)	1	_____	_____

Precaution of install the wire controller

1. This manual provides the installation method of wire controller. Please refer to the wiring diagram of this installation manual to wire the wire controller with indoor unit.
2. The wire controller working in low voltage loop circuit. Forbid to directly contact the cable of 220V commercial electricity or of 380V high voltage, and don't wire this kind of wire in the said loop; wiring clearance between configured tubes should at the range of 300~500 or above.
3. The Shielded wire of the wire controller must be grounded reliable.
4. Upon finish the wire controller connection, do not employed tramegger to detect the insulation.

3. Installation method

1. Dimensions

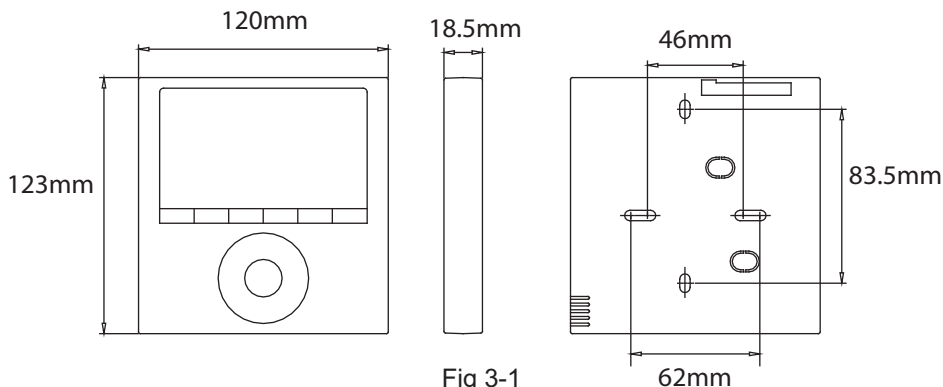

Fig 3-1

2. Remove the upper part of wire controller

- Insert a slot screwdriver into the slots in the lower part of the wire controller (2 places), and remove the upper part of the wire controller. (Fig.3-2)



NOTICE

The PCB is mounted in the upper part of the wire controller. Be careful not to damage the board with the slot screwdriver.

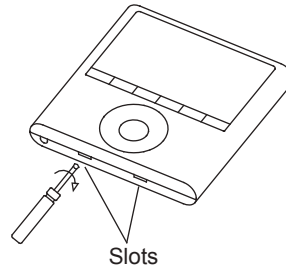

Fig 3-2

3. Fasten the back plate of the wire controller

- For exposed mounting, fasten the back plate on the wall with the 3 screws (M4×20) and plugs. (Fig.3-3)

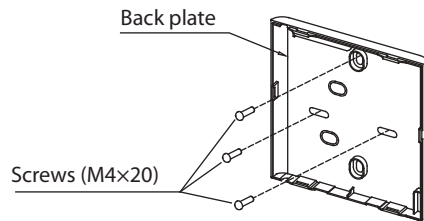

Fig 3-3

- For flush-mounting, fasten the back plate on the switch box with 2 screws (M4×25) and fasten it on the wall with 1 screw (M4×20). (Fig.3-4)

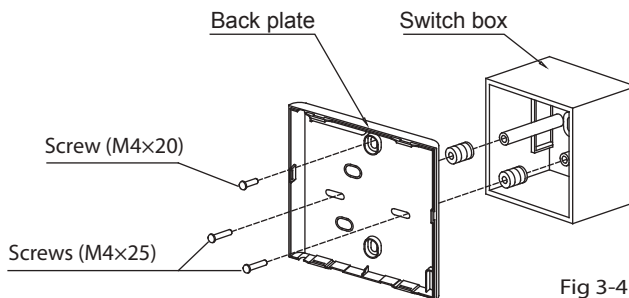

Fig 3-4



NOTICE

Put on a flat surface. Be careful not to distort the back plate of the wire controller by overtightening the mounting screws.

4. Battery installation

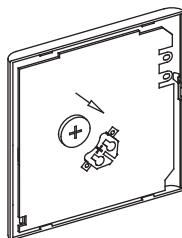

Fig 3-5

- Put the battery into the installationsite and make sure the positive side of the battery is in accordance with the positive side of installationsite.(See Fig.3-5)
- Please set the time corrected on the first time operation. Batteries in the wire controller can timing under power failure which ensure the time keep right. When the power restores, if the time displayed is not correct, it means the battery is dead and replace the battery.

5. Wire the indoor unit

4 methods

- 1 from the rear;
- 2 from the bottom;
- 3 from the top;
- 4 from the top center.

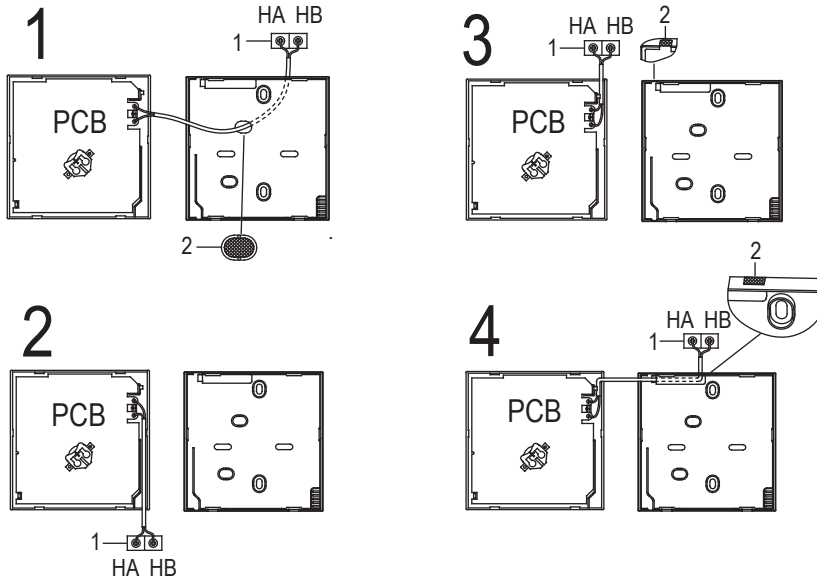

- 1 indoor unit
- 2 notch the part for the wiring to pass through with nippers, etc.

Connect the terminals on the remote controller (HA ,HB), and the terminals of the indoor unit (HA ,HB). (HA and HB do not have polarity.)

NOTE: DO NOT allow water to enter the remote control.
Use the trap and putty to seal the wires.

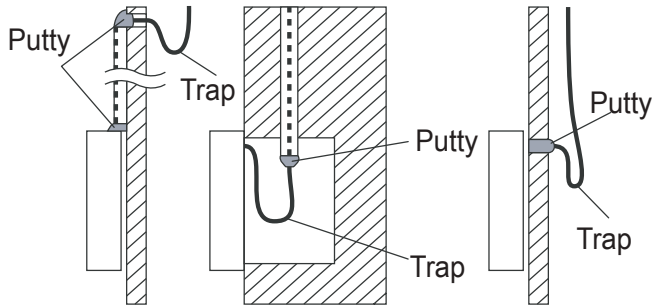

Fig 3-6

6. Reattach the upper part of the wire controller

- After adjusting the upper case and then buckle the upper case; avoid clamping the wiring during installation. (Fig 3-7)

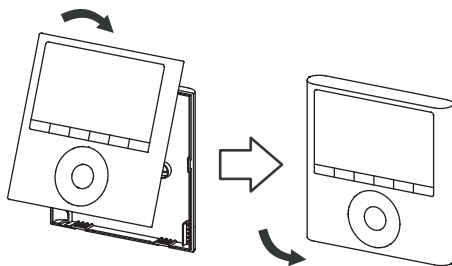

Fig 3-7

All the pictures in this manual are for explanation purpose only.
Your wire controller may be slightly different .The actual shape shall prevail.

4. Specification

Input voltage	DC 5V/DC 12V
Ambient temperature	-5~43°C (23~110°F)
Ambient humidity	RH40%~RH90%

Wiring specifications

Wiring type	Size	Total length
Shielded vinyl cord or cable	0.75-1.25mm ²	≤50m

5. Feature and function of the wired controller

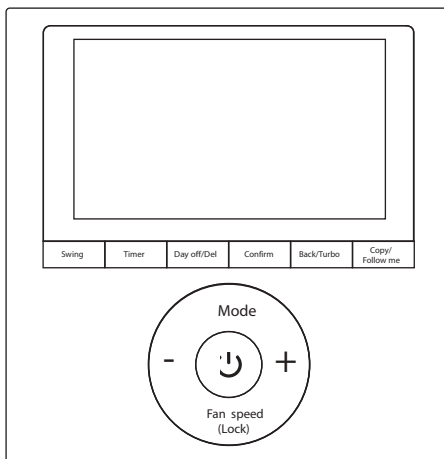

Feature:

LCD display.

Malfunction code display: it can display the error code, helpful for service.

4-way wire layout design, no raised part at backside, more convenient to place the wires and install the device.

Room temperature display.

Weekly Timer.

Function:

Mode: choose Auto-Cool-Dry- Heat -Fan

Fan speed: Auto/Low/Med/High speed

Swing(on some models)

Timer ON/OFF

Temp setting

Weekly timer

Follow me

Child Lock

LCD display

Clock

Faceplate function (on some models)

6. Name on the LCD of the wire controller

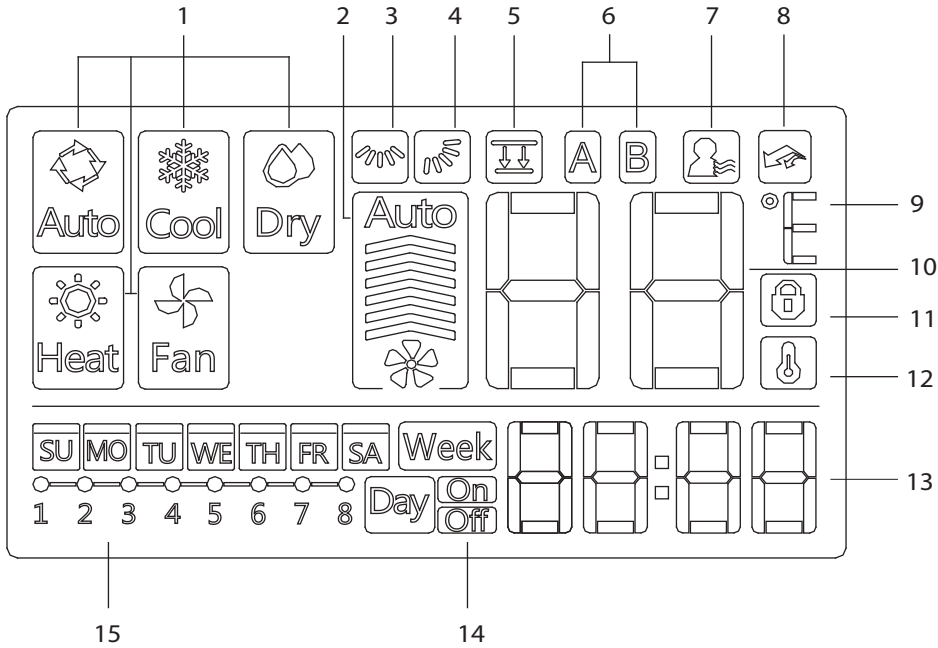

- | | |
|---|--------------------------------|
| 1 Operation mode indication | 8 Turbo function indication |
| 2 Fan speed indication | 9 C° / F° indication |
| 3 Left-right swing indication | 10 Temperature display |
| 4 Up-down swing indication | 11 Lock indication |
| 5 Faceplate function indication | 12 Room temperature indication |
| 6 Main unit and secondary unit indication | 13 Clock display |
| 7 Follow me function indication | 14 On/Off timer |
| | 15 Timer display |

7. Name of the button on the wire controller

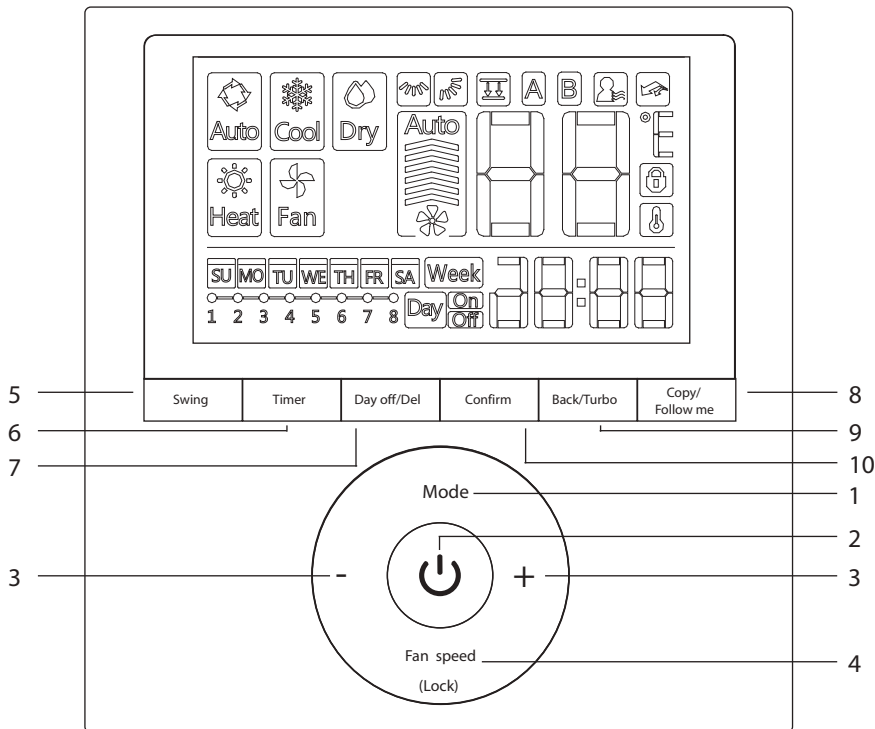



- | | |
|--------------------|-------------------------|
| 1 MODE button | 6 TIMER button |
| 2 POWER button | 7 DAY OFF/DEL button |
| 3 Adjust button | 8 COPY/FOLLOW ME button |
| 4 FAN SPEED button | 9 BACK/TURBO button |
| 5 SWING button | 10 CONFIRM button |

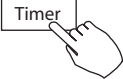

8. Preparatory operation

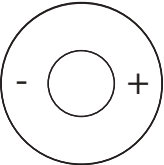
Set the current day and time

- 1  Press the TIMER button for 3 seconds or more. The timer display will flash.

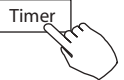
- 2  Press the button “+” or “-” to set the date. The selected date will flash.
 

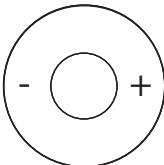
- 3  The date setting is finished and the time setting is prepared after pressing TIMER button or there is no pressing button in 10 seconds.

- 4  Press the button “+” or “-” to set the current time. Press repeatedly to adjust the current time in 1-minute increments. Press and hold to adjust the current time continuous.
 

ex. Monday AM 11:20

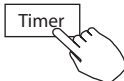
- 5  The setting is done after pressing TIMER button or there is no pressing button in 10 seconds.

9. Operation

To start/stop operation

-  Press the POWER button.

To set the operation mode

Operation mode setting

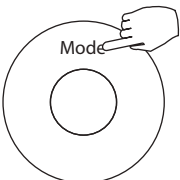
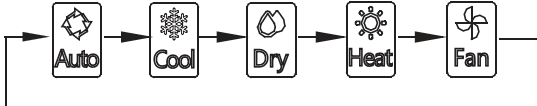
-  Press the MODE button to set the operation mode. (Heat function is invalid for cool only type unit)
- 

Room temperature setting

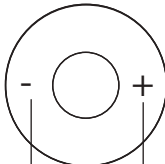
-  Press the button “+” or “-” to set the room temperature. Indoor Setting Temperature Range : 17~30°C (62~86°F/62~88°F).
- Lower Raise

Fan speed setting

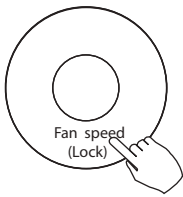

Press the FAN SPEED button to set the fan speed.
(This button is unavailable when in the mode of Auto or Dry)

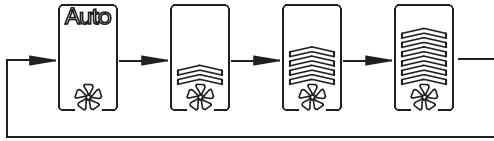

Room temperature sensor selection

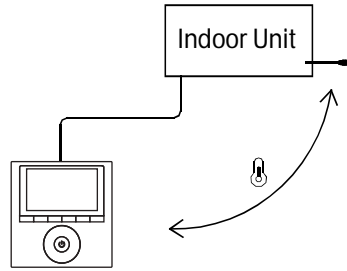
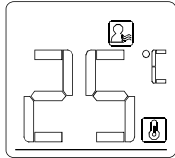
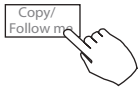

Press the Follow me button to select whether the room temperature is detected at the indoor unit or the wire controller.

When the Follow me function indication  appears, the room temperature is detected at the wire controller.

Child lock function

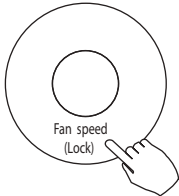

Press the Lock button for 3 seconds to activate the child lock function and lock all buttons on the wire controller.
Press the button again for 3 seconds to deactivate the child lock function.

When the child lock function is activated, the  mark appears.

Keypad tone setting



Press the buttons Swing and Timer simultaneously for 3 seconds to close the keypad tone.
Press the buttons again for 3 seconds to open the keypad tone.

°C & °F scale selection (on some models)



Press the buttons Back and Copy simultaneously for 3 seconds will alternate the temperature display between the °C&°F scale.

Turbo function (on some models)



Press the Turbo button to activate the turbo function.
Press the button again to deactivate the turbo function.

When the turbo function is activated, the  mark appears.

Faceplate function (on some models)

1. When the unit is off, Press the Mode(A/B) button long to activate the faceplate function. The  mark will flash.

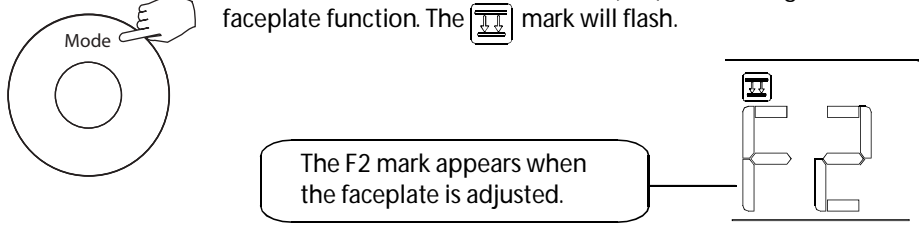

2. Push the Mode(A/B) button to select Unit A or Unit B, the wire controller select in a sequence that goes from (this step do not need to perform if the wire controller is connected with one unit only):

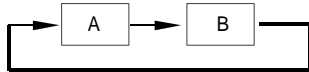

3. Press the button "+" and "-" to control the lift and drop of the faceplate. Pressing the "+" button can stop the faceplate, while it is dropping. Pressing the "-" button can stop the faceplate, while it is lifting.

Left-right airflow swing (on some models)

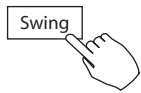

Press the swing button long to activate the auto Left-right swing function. And then the louver would swing automatically. Press it again to stop.

When the auto Left-right swing feature of the louver is activated, the  mark appears. (Not applicable to all the models)

Up-Down airflow direction and swing (on some models)

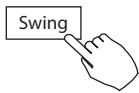

Press the Swing button to start up-down swing function. Press it again to stop. When the Up-Down swing function is activated, the  mark appears. (Not applicable to all the models)

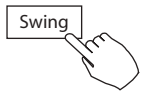

Swing function (For the unit without left & right auto swing function models)

Up-Down airflow direction and swing



- Use Swing button to adjust the Up-down airflow direction.
 1. Press the button every time, the louver swings 6 degrees.
 2. Press and hold the button for 2 seconds, it turns into up-down swing mode, press it again to stop.
 When the Up-Down swing function is activated, the  mark appears. (Not applicable to all the models)

• The operation can refer to the following instructions for the unit with four Up-Down louvers can be operated individually.

1. Press the Swing button to activate the Up-Down adjusting louver function. The  mark will flash. (Not applicable to all the models)
2. Pressing the button "+" or "-" can select the movement of four louvers. Each time you push the button, the wire controller select in a sequence that goes from: (the icon  means the four louvers move at the same time.)

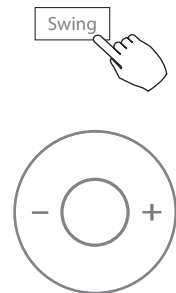
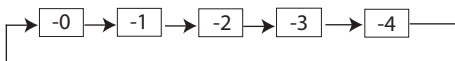



3. And then use Swing button to adjust the Up-Down airflow direction of the selected louver.

10. Timer functions

- 
On timer
 Use this timer function to start air conditioner operation. The timer operates and air conditioner operation starts after the time has passed.



- 
Off timer
 Use this timer function to stop air conditioner operation. The timer operates and air conditioner operation stops after the time has passed.

- 
On and Off timer
 Use this timer function to start and stop air conditioner operation. The timer operates and air conditioner operation starts and stops after the time has passed.

- 
WEEKLY timer
 Use this timer function to set operating times for each day of the week.



10.1. Timer ON and/or Timer OFF

To set the On or Off TIMER

- 1**  Press the TIMER button to select the  or .

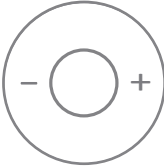

- 2**  Press the CONFIRM button and the Clock display is flashing.

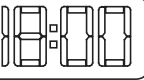

- 3**   

ex. Off timer set at PM 6:00

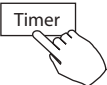

Press the button “+” or “-” to set the time. After the time is set, the timer will start or stop automatically.

- 4**  Press the CONFIRM button again to finish the settings.

To set the On and Off TIMER

1  Press the TIMER button to select the .

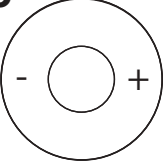
2  Press the CONFIRM button and the Clock display is flashing.

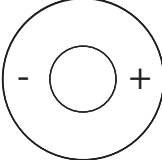

3   Press the button “+” or “-” to set the time of On timer, and then press the CONFIRM button to confirm the setting.

4  Press the button “+” or “-” to set the time of Off timer.

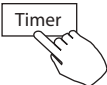

5  Press the CONFIRM button to finish the settings.

10.2 Weekly timer

1 Weekly timer setting

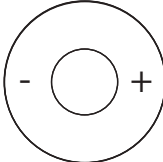

  Press the Timer button to select the  and then press the Confirm button to confirm.

2 Day of the week setting

  Press the button “+” or “-” to select the day of the week and then press the Confirm button to confirm the setting.

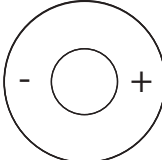

3 ON timer setting of timer setting 1

  Press the button “+” or “-” to set the time of On timer and then press the Confirm button to confirm the setting.

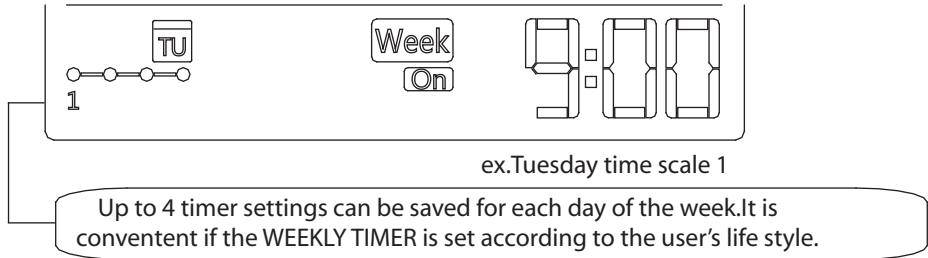

ex. Tuesday time scale 1

Up to 4 timer settings can be saved for each day of the week. It is convenient if the WEEKLY TIMER is set according to the user's life style.

4 Off timer setting of timer setting 1

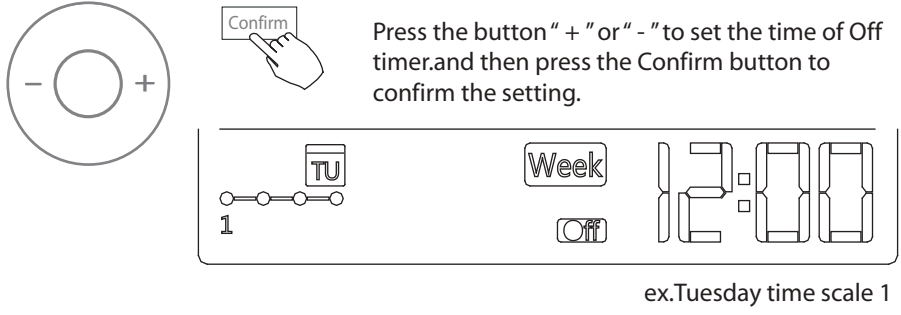

Press the button “+” or “-” to set the time of Off timer. and then press the Confirm button to confirm the setting.

ex. Tuesday time scale 1

5 Different timer settings can be set by repeating step 3 to 4.

6 Other days in one week can be set by repeating step 2 to 5.

NOTE: The weekly timer setting can be returned to the previous step by pressing Back button.
 The time of timer setting can be delete by pressing Day off button
 The current setting will be restored and withdrawn the weekly timer setting automatically when there is no operation for 30 seconds.

WEEKLY timer operation

To activate WEEKLY TIMER operation

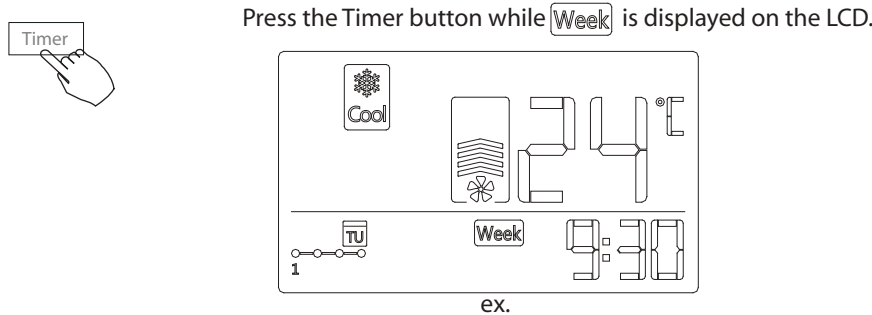

Press the Timer button while **Week** is displayed on the LCD.

ex.

To deactivate WEEKLY TIMER operation

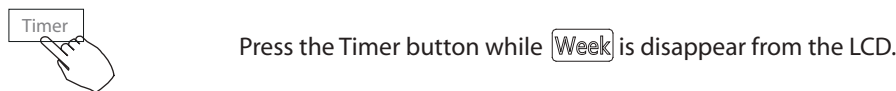

Press the Timer button while **Week** is disappear from the LCD.

• To turn off the air conditioner during the weekly timer

1. If press the Power button once and quickly , the air conditioner will turn off temporarily. And the air conditioner will turn on automatically until the time of On timer.

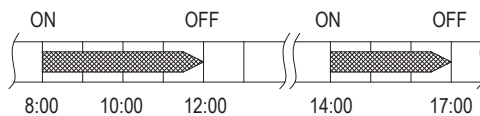



ex. If press the POWER button once and quickly at 10:00, The air conditioner will turn on at 14:00.

2. When press the Power button for 2 seconds , the air conditioner will turn off completely.

To set the DAY OFF (for a holiday)

1  During the weekly timer, press the Confirm button.

2  Press the button “ + ” or “ - ” to select the day in this week .

3  Press the Day off button to set the DAY OFF.

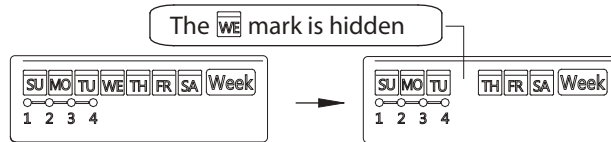

ex.The DAY OFF is set for Wednesday

4 The DAY OFF can be set for other days by repeating the steps 2 and 3.

5  Press the Back button to back to the weekly timer.

To cancel: Follow the same procedures as those for setup.

Notes:

The DAY OFF setting is cancelled automatically after the set day has passed.

DELAY function



During the weekly timer, pressing the Del button once,display "0H".

Press this button twice,display "1H" and wait 3 seconds to confirm.
It means the unit will override 1 hours;

Press this button three times,display "2H" and wait 3 seconds to confirm.
It means the unit will override 2 hours;

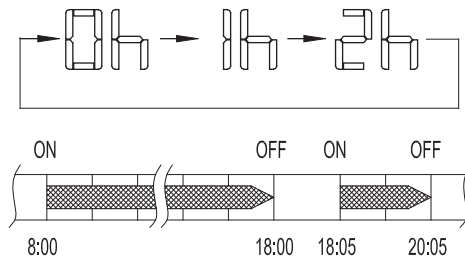

ex. If press the DEL button to select "2H" at 18:05 ,
The air conditioner will delay to turn off at 20:05.

Copy out the setting in one day into the other day.

A reservation made once can be copied to another day of the week.
The whole reservation of the selected day of the week will be copied.
The effective use of the copy mode ensures ease of making reservations.

1  During the weekly timer,press the Confirm button.

2  Press the button “ + ” or “ - ” to select the day to copy from.

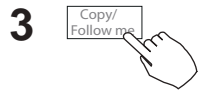

Press the Copy button, the letter "CY" will be shown on the LCD.



Press the button "+" or "-" to select the day to copy to.



Press the Copy button to confirm .

The  mark flashes quickly

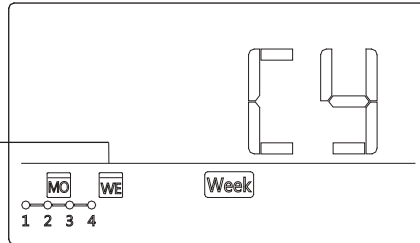

ex. Copy the setting of Monday to Wednesday

6 Other days can be copied by repeating step 4 and 5.



Press the Confirm button to confirm the settings.

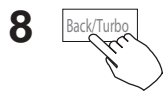

Press the Back button to back to the weekly timer.

11. Fault alarm handing

If the system does not properly operate except the above mentioned cases or the above mentioned malfunctions is evident, investigate the system according to the following procedures.

NO.	MALFUNCTION & PROTECTION DEFINE	DISPLAY DIGITAL TUBE
1	Error of communication between wire controler and indoor unit	F0
2	The faceplate is abnormal	F1

Please check the error display of indoor unit and read <<OWNER'S MANUAL>> if other error code appears.

12. Technical indication and requirement

EMC and EMI comply with the CE certification requirements.

Note:

The design and specifications are subject to change without prior notice for product improvement. Consult with the sales agency or manufacturer for details

MUNDO  CLIMA®



www.mundoclima.com

ASK FOR MORE INFORMATION

Phone: (+34) 93 446 27 81

eMail: info@mundoclima.com

TECHNICAL ASSISTANCE

Phone: (+34) 93 652 53 57