

Cassette FCU DC

Installation and
owner's manual

MUCS-W7



CONTENT

INSTALLATION MANUAL 3

OWNER'S MANUAL 12

REMOTE CONTROLLER 20

IMPORTANT

Thank you for selecting super quality Air Conditiones. To ensure satisfactory operation for many ears to come, this manual should be read carefully before the installation and before using the air conditioner. After reading, store it a safe place. Please refer to the manual for questions on use or in the event that any irregularities occur. This Air Conditioner should be used for hosehold use.

WARNING

The power supply must be SINGLE-PHASE (one phase (L) and one neutral (N)) with his grounded power (GND)) or THREE-PHASE (three phase (L1, L2, L3) and one neutral (N) with his grounded power (GND)) and his manual switch. Any breach of these specifications involve a breach of the warranty conditions provided by the manufacturer.

NOTE

In line with the company's policy of continual product improvement, the aesthetic and dimensional characteristics, technical data and accessories of this appliance may be changed without notice.

ATTENTION

Read this manual carefully before installind or operating you new air conditioning unit. Make sure to save this manual for future reference.

INSTALLATION MANUAL

Read This Manual:

Please read this manual carefully before installing and using the unit.

Inside you will find many helpful hints on how to use and maintain your air conditioner properly.

Just a little preventative care on your part can save you a great deal of time and money over the life of your air conditioner.

You'll find many answers to common problems in the chart of troubleshooting tips. If you review the chart of Troubleshooting Tips first, you may not need to call for service.

CONTENTS	PAGE
PRECAUTIONS.....	4
INSTALLATION INFORMATION.....	5
ATTACHED FITTINGS.....	6
INSPECTING AND HANDLING THE UNIT.....	7
INDOOR UNIT INSTALLATION.....	7
CONNECT THE DRAIN PIPE	9
WIRING	10

1. PRECAUTIONS

- **Be sure to be in conformity with the local, national and international laws and regulations.**
- **Read "PRECAUTIONS" carefully before installation.**
- **The following precautions include important safety items. Observe them and never forget.**
- **Keep this manual with the owner's manual in a handy place for future reference.**
- **Before out from factory, FAN COIL UNIT (AIR UNITS) has passed Fan Coil Overpressure Resistant Test, Statically and Dynamically Balanced Adjustment, Noise Test, Air (cool) Volume Test, Electric Property Test, Outline Quality Detection.**

The safety precautions listed here are divided into two categories. In either case, important safety information is listed which must be read carefully.

 **WARNING**
Failure to observe a warning may result in death.

 **CAUTION**
Failure to observe a caution may result in injury or damage to the equipment.

After completing the installation, make sure that the unit operates properly during the start-up operation. Please instruct the customer on how to operate the unit and keep it maintained. Also, inform customers that they should store this installation manual along with the owner's manual for future reference.

 **WARNING**

Be sure only trained and qualified service personnel to install, repair or service the equipment.

Improper installation, repair, and maintenance may result in electric shocks, short-circuit, leaks, fire or other damage to the equipment.

Install according to this installation instructions strictly. If installation is defective, it will cause water leakage, electric shocks, fire.

Use the attached accessories parts and specified parts for installation.

otherwise, it will cause the set to fall, water leakage, electrical shock fire.

Install at a strong and firm location which is able to withstand the set's weight.

If the strength is not enough or installation is not properly done, the set will drop to cause injury.

The appliance must be installed 2.3m above floor.

The appliance shall not be installed in the laundry.

Before obtaining access to terminals, all supply circuits must be disconnected.

The appliance must be positioned so that the plug is accessible.

The enclosure of the appliance shall be marked by word, or by symbols, with the direction of the fluid flow.

For electrical work, follow the local national wiring standard, regulation and this installation instructions. An independent circuit and single outlet must be used.

If electrical circuit capacity is not enough or defect in electrical work, it will cause electrical shock fire.

Use the specified cable and connect tightly and clamp the cable so that no external force will be acted on the terminal.

If connection or fixing is not perfect, it will cause heat-up or fire at the connection.

Wiring routing must be properly arranged so that control board cover is fixed properly.

If control board cover is not fixed perfectly, it will cause heat-up at connection point of terminal, fire or electrical shock.

If the supply cord is damaged, it must be replaced by the manufacture or its service agent or similarly qualified person in order to avoid a hazard.

An all-pole disconnection switch having a contact separation of at least 3mm in all poles should be connected in fixed wiring.

This appliance can be children aged from 8 years and above and persons with reduced physical, sensory or mental capabilities or lack of experience and knowledge if they have been given supervision or instruction.

Do not modify the length of the power supply cord or use of extension cord, and do not share the single outlet with other electrical appliances.

Otherwise, it will cause fire or electrical shock.

If the water leaks during installation, ventilate the area immediately.

After completing the installation work, check that the water does not leak.

The cool water in the unit is not lower than 3°C, hot water is not higher than 70°C. Water in the unit must clean, air quality must meet to the standard of PH=6.5-7.5.



CAUTION

Ground the air conditioner.

Do not connect the ground wire to gas or water pipes, lightning rod or a telephone ground wire. Incomplete grounding may result in electric shocks.

Be sure to install an earth leakage breaker.

Failure to install an earth leakage breaker may result in electric shocks.

Connect the outdoor unit wires, then connect the indoor unit wires.

You are not allowed to connect the air conditioner with the power source until wiring (including piping) of the air conditioner is done.

While following the instructions in this installation manual, install drain piping in order to ensure proper drainage and insulate piping in order to prevent condensation.

Improper drain piping may result in water leakage and property damage.

Install the indoor and outdoor units, power supply wiring and connecting wires at least 1 meter away from televisions or radios in order to prevent image interference or noise.

Depending on the radio waves, a distance of 1 meter may not be sufficient enough to eliminate the noise.

The appliance is not intended for use by young children or infirm persons without supervision.

Young children should be supervised to ensure that they do not play with the appliance.

Don't install the air conditioner in the following locations:

- There is petrolatum existing.
- There is salty air surrounding (near the coast).
- There is caustic gas (the sulfide, for example) existing in the air (near a hot spring).
- The Volt vibrates violently (in the factories).
- In buses or cabinets.
- In kitchen where it is full of oil gas.
- There is strong electromagnetic wave existing.
- There are inflammable materials or gas.
- There is acid or alkaline liquid evaporating.
- The appliance shall not be installed in the laundry.
- Avoid installing it in a narrow space which has a high requirement to noise.
- Other special conditions.

2. INSTALLATION INFORMATION













- To install properly, please read this "installation manual" at first.
- The air conditioner must be installed by qualified persons.
- When installing the indoor unit or its tubing, please follow this manual as strictly as possible.
- If the air conditioner is installed on a metal part of the building, it must be electrically insulated according to the relevant standards to electrical appliances.
- When all the installation work is finished, please turn on the power only after a thorough check.
- Regret for no further announcement if there is any change of this manual caused by product improvement.

INSTALLATION ORDER

- Select the location;
- Install the FCU;
- Install the water pipe;
- Connect the drain pipe;
- Wiring;
- Test operation.

3. ATTACHED FITTINGS

Please check whether the following fittings are of full scope. If there are some spare fittings, please restore them carefully.

	NAME	SHAPE	Four-way Cassette	Four-way Cassette (compact)
INSTALLATION FITTINGS	1. Installation paper board		1	1
	2. Bolt M6		4	
	3. Soundproof / insulation sheath		2	2
Drainpipe Fittings	4. Out-let pipe		1	1
	5. Out-let pipe sheath		1	
	6. Out-let pipe clasp		1	1
	7. Tightening band		5	5
Remote controller & Its Frame	8. Remote controller		1	1
	9. Frame		1	1
	10. Mounting screw (ST2.9X10-C-H)		2	2
	11. Alkaline dry batteries (AM4)		2	2
Others	12. Installation and owner's manual	This manual	1	1

Cautions on remote controller installation:

- Never throw or beat the controller.
- Before installation, operate the remote controller to determine its location in a reception range.
- Keep the remote controller at least 1m apart from the nearest TV set or stereo equipment. (it is necessary to prevent image disturbances or noise interferences.)
- Do not install the remote controller in a place exposed to direct sunlight or close to a heating source, such as a stove.
- Note that the positive and negative poles are right positions when loading batteries.
- This manual is subject to changes due to technological improvement without further notices.

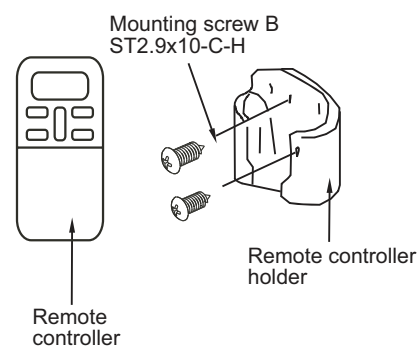



Fig.3-1

4. INSPECTING AND HANDLING THE UNIT

At delivery, the package should be checked and any damage should be reported immediately to the carrier claims agent.

When handling the unit, take into account the following:

- 1  Fragile, handle the unit with care.
 Keep the unit upright in order to avoid compressor damage.
- 2 Choose on before hand the path along which the unit is to be brought in.
- 3 Move this unit as originally package as possible.
- 4 When lifting the unit , always use protectors to prevent belt damage and pay attention to the position of the unit's centre of gravity.

5. INDOOR UNIT INSTALLATION

5.1 Installation place

(refer to fig.5-1,fig.5-2,fig.5-3 and table 5-1 for specification.)

The indoor unit should be installed in a location that meets the following requirements:

- Avoid installing it in a narrow sapce which has a high requirement to noise.
- The ceiling is horizontal, and its structure can endure the weight of the indoor unit.
- The outlet and the inlet are not impeded, and the influence of external air is the least.
- The air flow can reach throughout the room.
- The connecting pipe and drainpipe could be extracted out easily.
- There is no direct radiation from heaters.
- Don't install it in a place whose air contains much salt. If this can't be avoided, choose a anticorrosive model.



CAUTION

Installing the equipment in any of the following places may lead to faults of the equipment (if that is inevitable, consult the supplier):

- A. The site contains mineral oils such as cutting lubricant.
- B. Seaside where the air contains much salt.
- C. Hotpring area where corrosive gases exist, e.g., sulfide gas.
- D. Factories where the supply voltage fluctuates seriously.
- E. Inside a car or cabin.
- F. Place like kitchen where oil permeates.
- G. Place where strong electromagnetic waves exist.
- H. Place where flammable gases or materials exist.
- I. Place where acid or alkali gases evaporate.
- J. Other special environments.

5.2 Installation procedures for fresh air intake duct connection

- **Preparing the connection hole**
 - Cut off the knockout hole on the side plate with a nipper.
 - Cut the inner insulation of the hole portion with a cutter. (refer to fig.5-4)
- **Placing the insulation**
 - Put the insulation tightly around the hole of the unit as shown.
The ends of the side plate and the inner insulation must be completely adhered without leaving any clearance along the circumference of the hole.
Make sure the inner surface of insulation tightly contacts the inner insulation edge and the side plate. (refer to fig.5-5)

5.3 Install the main body

■ The existing ceiling (to be horizontal)

- 1 Cut a quadrangular hole of 880x880mm in the ceiling according to the shape of the installation paper board.
 - The center of the hole should be at the same position of that of the air conditioner body.
 - Determine the lengths and outlets of the connecting pipe, drainpipe and cables.
 - To balance the ceiling and to avoid vibration, please enforce the ceiling when necessary.
- 2 Select the position of installation hooks according to the hook holes on the installation board.
 - Drill four holes of $\phi 12$ mm, 50~55mm deep at the selected positions on the ceiling. Then embed the expansible hooks (fittings).
 - Face the concave side of the installation hooks toward the expansible hooks. Determine the length of the installation hooks from the height of ceiling, then cut off the unnecessary part.
 - If the ceiling is extremely high, please determine the length of the installation hook according to facts.
- 3 Adjust the hexangular nuts on the four installation hooks evenly, to ensure the balance of the body.
 - If the drainpipe is awry, leakage will be caused by the malfunction of the water-level switch.
 - Adjust the position to ensure the gaps between the body and the four sides of ceiling are even. The body's lower part should sink into the ceiling for 10~12 mm (refer to fig.5-6)
 - In general, L is half of the screw length of the installation hook.(refer to fig.5-6)
 - Locate the air conditioner firmly by wrenching the nuts after having adjusted the body's position well.(refer to fig.5-7)

■ New built houses and ceilings

- 1 In the case of new built house, the hook can be embedded in advance (refer to 2 mentioned above). But it should be strong enough to bear the indoor unit and will not become loose because of concrete shrinking.
- 2 After installing the body, please fasten the installation paper board onto the air conditioner with bolts(M6X12) to determine in advance the sizes and positions of the hole opening on ceiling.(refer to fig.5-8)
 - Please first guarantee the flatness and horizontal of ceiling when installing it.
 - Refer to 1 mentioned above for others.
- 3 Refer to 3 above for installation.
- 4 Remove the installation paper board.



CAUTION

After installing the body, the four bolts(M6x12)must be fastened to the air conditioner onto ensure the body is grounded well.

FIGURES

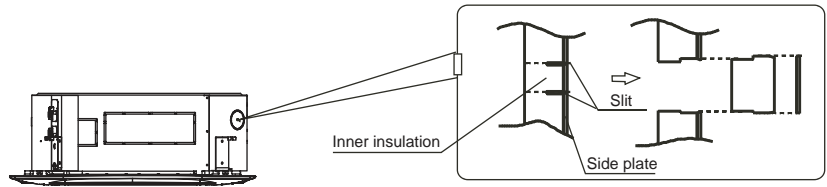
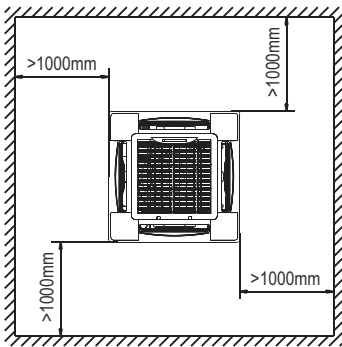
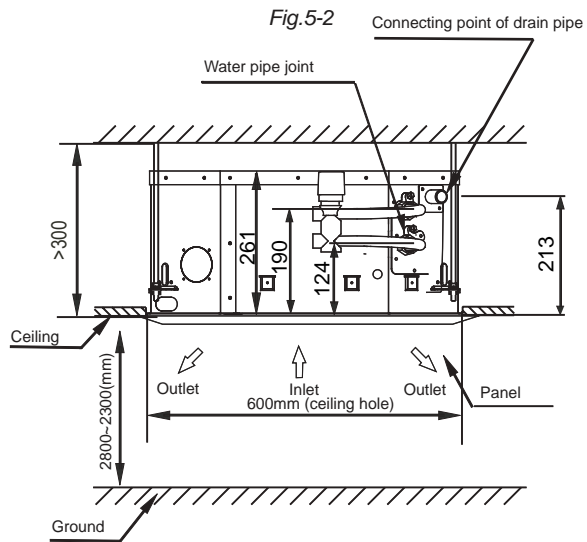
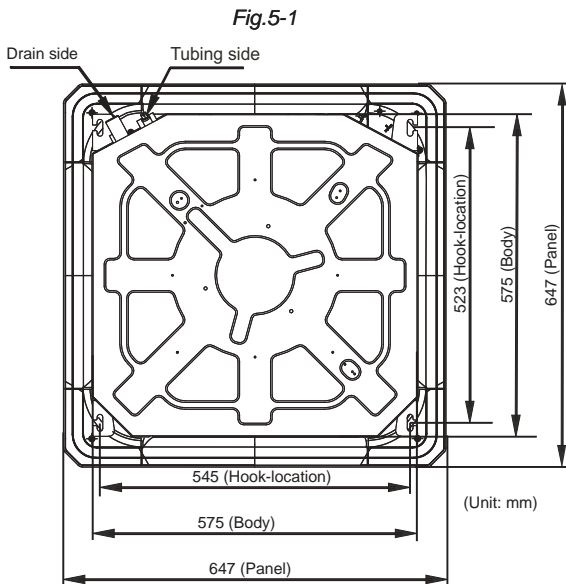

Fig.5-3

Fig.5-4

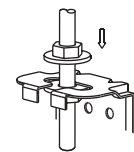
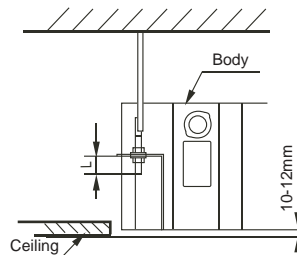
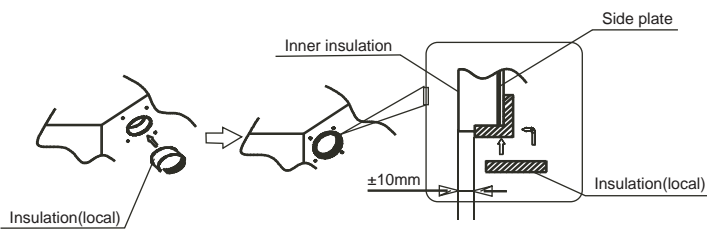

Fig.5-5

Fig.5-6

Fig.5-7

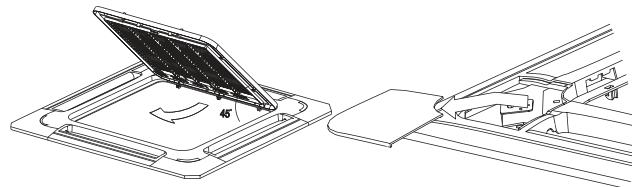
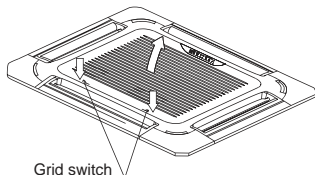
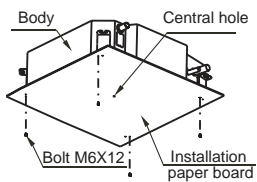

Fig.5-8

Fig.5-9

Fig.5-10

Fig.5-11

NOTE

All the pictures in this manual are for explanation purpose only. They may be slightly different from the air conditioner you purchased(depend on model).The actual shape shall prevail.

5.4 Install The Panel



CAUTION

Never put the panel face down on floor or against the wall, or on bulky objects.

Never crash or strike it.

1 Remove the air-in grill.

- Slide two grill switches toward the middle at the same time, and then pull them up. (Refer to fig.5-9)
- Draw the grill up to an angle of about 45°, and remove it. (Refer to fig.5-10)

2 Remove the installation covers at the four corners

- Wrench off the bolts, loose the rope of the installation covers, and remove them. (Refer to fig.5-11)

3 Install the panel

- Align the swing motor on the panel to the tubing joints of the body properly.
- Fix hooks of the panel at swing motor and its opposite sides to the hooks of corresponding water receiver. Then hang the other two panel hooks onto corresponding hangers of the body.



CAUTION

Do not coil the wiring of the swing motor into the seal sponge.

- Adjust the four panel hook screws to keep the panel horizontal, and screw them up to the ceiling evenly.
- Regulate the panel in the direction of the arrow slightly to fit the panel's center to the center of the ceiling's opening. Guarantee that hooks of four corners are fixed well.
- Keep fastening the screws under the panel hooks, until the thickness of the sponge between the body and the panel's outlet has been reduced to about 4~6mm. The edge of the panel should contact with the ceiling well.
 - If the gap between the panel and ceiling still exists after fastening the screws, the height of the indoor unit should be modified again.
 - You can modify the height of the indoor unit through the openings on the panel's four corners, if the lift of the indoor unit and the drainpipe is not influenced .

4 Hang the air-in grill to the panel, then connect the lead terminator of the swing motor and that of the control box with corresponding terminators on the body respectively.

5 Relocate the air-in grill in the procedure of reversed order.

6 Relocate the installation cover.

- Fasten the rope of installation cover on the bolt of the installation cover.
- Press the installation cover into the panel slightly.

6. CONNECT THE DRAIN PIPE

6.1 Install the drain pipe of indoor unit

- 1) The drainpipe can use PVC pipe (external diameter about 37~39mm, inner diameter is 32mm).
- 2) Joint drainpipe connector to the end side of water pumping pipe, and fix drainpipe together with water outflow pipe and thermal insulation tube by clasp of water outflow pipe (attached).



CAUTION

Don't use forcing strength to crack the water-pumping pipe.

- 3) Water-pumping pipe and drainpipe from main body must be wrapped by insulation tube evenly, and bound by tighten band for obstructing air getting in and coagulation.
- 4) Prevent from water backflow into unit inside during shutdown, the drain pipe shall place down side and drain water to outdoor (drain side), the gradient of the drain pipe should be higher than (1/100), without salient and water remain.(Refer to Fig.6-1 a)
- 5) When connecting drainpipe, don't drag the pipe that would pull the main unit. For this, please arrange bearing points every 0.8 to 1.0 meter to avoid pipe be bended (See Fig.6-1 b).
- 6) When connect a lengthen drainpipe, apply protective tube to wrap its indoor parts for ensuring the lengthen part connected tightly.
- 7) In case the drainpipe outlet is higher than pumping connective pipe of the main body, the drainpipe must be arranged upwards vertically by using connective assembly of the water outlet for vertical bending, and the height of the drainpipe shall set to the defrosting pan surface no more than 1000mm, otherwise, too much backflow while shutdown would leads to overflow (Refer to Fig.6-2).
- 8) Base on the actual requirement to bend piping, and use connective assembly of water outlet in terminal box for pipe layout.



CAUTION

The joints in drain system must be sealed to avoid water leakage.

- 9) The height from floor to the end of drainpipe or the bottom of drain slot must more than 50 mm. Don't immerse the end of drainpipe or the bottom of drain slot into water. When drain condensate liquid to raceway, please bend the drainpipe to a U-sharped hydroseal for avoiding stench transmitted by drainpipe to indoor.

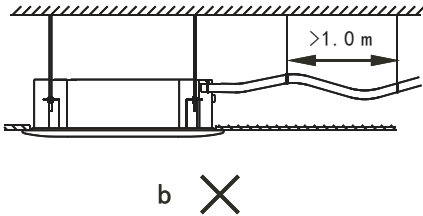
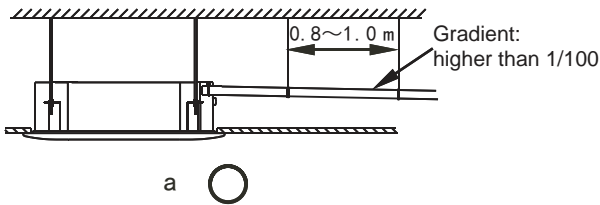

Fig.6-1

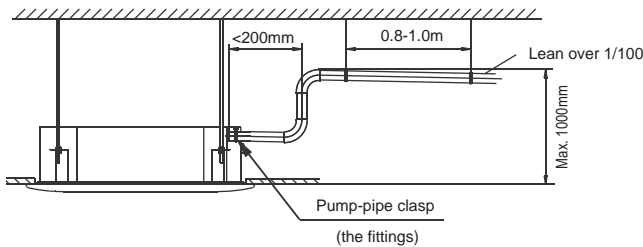

Fig.6-2

6.2 Drainage test

- Check whether the drainpipe is unhindered
- New built house should have this test done before paving the ceiling.
 - 1、 Remove the test cover, and stow water of about 2000ml to the water receiver through the stow tube. (Refer to Chart 19)
 - 2、 Turn on the power, and operate the air conditioner under the "COOLING" mode. Listen to the sound of the drain pump. Check whether the water is discharged well (a lag of 1min is allowed before discharging, according to the length of the drain pipe), and check whether water leaks from the joints.

CAUTIONS: If there is any malfunction, please resolve it immediately.

 - 3、 Stop the air conditioner for three minutes, check if everything is ok. If the drain hose is located unreasonable, water overflow will cause the Alarm indicator lamp flashing (For both cooling and heating type or cooling only type), even the water leak out from the water receiver.
 - 4、 Check the drain pump whether drain water immediately when alarm sound for the high water level. If the water level can't come down below to the limited water level, the air conditioner will stop. Restart it until turn off the power and drain off all the water.
 - 5、 Turn off the power, drain the water away.
- The drain plug is used to empty the water-receiver for maintenance of the air conditioner. Please stuff it in position at all times during operation to avoid leakage.

7. WATER PIPE INSTALLATION

7.1 Material and Size of the Piping

Table 7-1

Pipe Material	Copper Pipe	
Connections	3/4"	3/4"
	3/4"	3/4"

7.2 Connection of the Water Pipe

Connection of the water pipe should be done by professionals. Double-span should be used when connecting pipes of Indoor Unit.



NOTE

Please refer to installation instructions for the water piping connection of the air conditioner that with throttle device inside.

8. WIRING



CAUTION

The air conditioner should use separate power supply with rated voltage.

The external power supply to the air conditioner should have ground wiring, which is linked to the ground wiring of the indoor and outdoor unit.

The wiring work should be done by qualified persons according to circuit drawing.

an all-pole disconnection device which has at least 3mm separation distance in all pole and a residual current device(RCD)with the rating of above 10mA shall be incorporated in the fixed wiring according to the national rule.

The appliance shall be installed in accordance with national wiring regulations.

Be sure to locate the power wiring and the signal wiring well to avoid cross-disturbance.

Do not turn on the power until you have checked carefully after wiring.

8.1 Connect the cable

- Disassemble the bolts from the cover.
- Connect the connective cables to the terminals as identified with their respective mached numbers on the terminal block.
- Re-install the cover or the protection board.

The power supply specifications are as following, see table 8-1. If the capacity of wire is too small, it may result in overheating on the wire and cause the machine burned out.

Table 8-1

MODEL		14 / 16
POWER	PHASE	1-phase
	FREQUENCY AND VOLT	220-240V~ 50Hz
CIRCUIT BREAKER/FUSE(A)		15/15
INDOOR UNIT POWER WIRING(mm ²)	BELOW 20M	Twisted pairwire 2.5mm ²
	BELOW 50M	Twisted pairwire 6mm ²
GROUND WIRING(mm ²)		2.5

The power cord type designation is H05RN-F or above.



CAUTION

The reserved function is indicated in broken line table, users can select it when necessary.

An all-pole disconnection device which has at least 3mm separation distance in all pole and a residual current device (RCD) with the rating of above 10mA shall be incorporated in the fixed wiring according to the national rule.

8.2 Terminal Board Diagram

Please refer to the indoor unit wiring diagram for the wiring.



NOTE

The air-conditioners can connect with Central Control Monitor (CCM). Before operation, please wiring correctly and set system address and network address of indoor units.

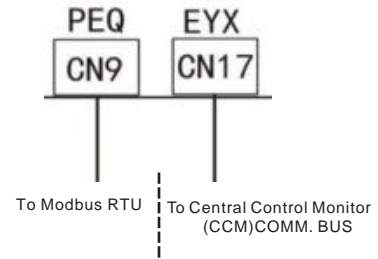
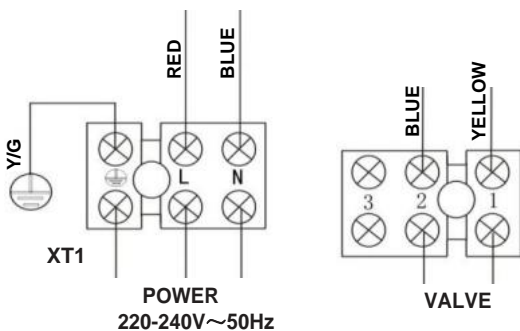
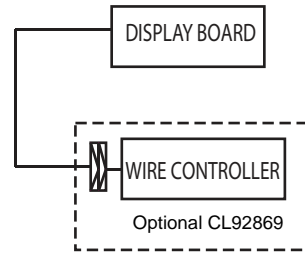

Fig.8-1

Please adopt the shielded twisted-pair wire, and connect the shielded layer to E



The reserved wire control function is indicated in broken line table, users can purchase the wire controller when necessary.

8.3 Network address set

Every unit in network has only one network address to distinguish each other. Address code of each unit in LAN is set by code LAN is set by code switch on the PCB and the set range is 0-63.

Table 8-2

Toggle switch set			Network address code
SW1	ENC2		
			00~15
			16~31
			32~47
			48-63

OWNER'S MANUAL

Read This Manual:

Please read this manual carefully before installing and using the unit.

Inside you will find many helpful hints on how to use and maintain your air conditioner properly.

Just a little preventative care on your part can save you a great deal of time and money over the life of your air conditioner.

You'll find many answers to common problems in the chart of troubleshooting tips. If you review the chart of Troubleshooting Tips first, you may not need to call for service.

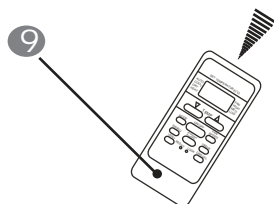
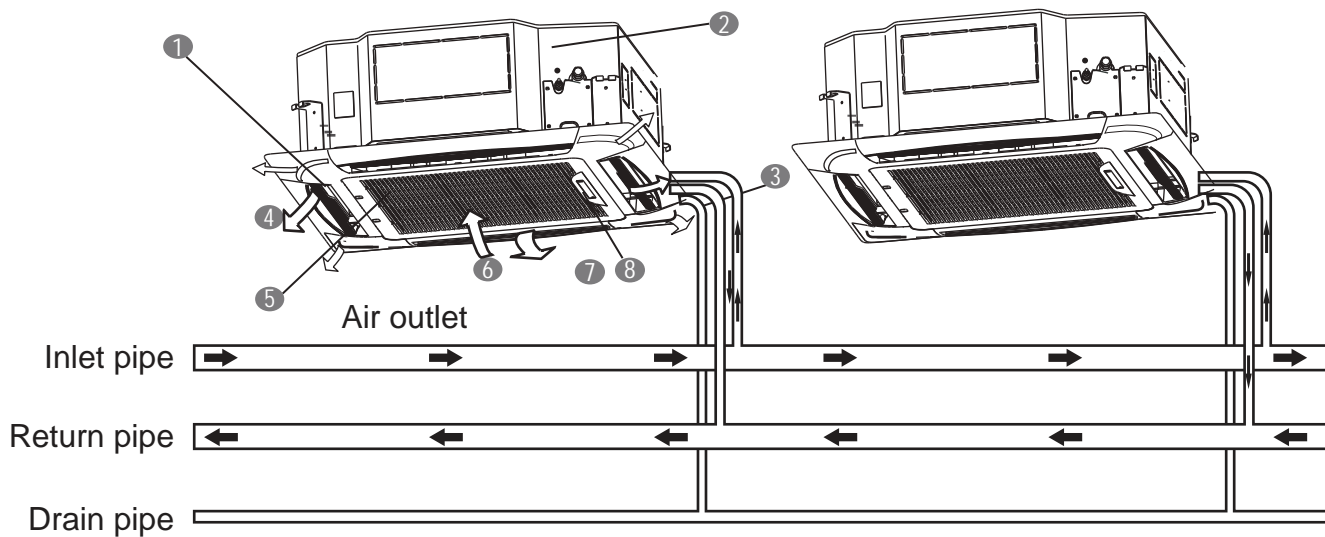

- | | |
|-------------------------------------|---------------------|
| ① Air flow louver (at air outlet) | ⑥ Air inlet |
| ② Drain pump (drain water from FCU) | ⑦ Air-in grill |
| ③ Drain pipe | ⑧ Display panel |
| ④ Air outlet | ⑨ Remote controller |
| ⑤ Air filter (inside air-in grill) | |



NOTE

All the pictures in this manual are for explanation purpose only. They may be slightly different from the air conditioner you purchased(depend on model).The actual shape shall prevail.

CONTENTS	PAGE
IMPORTANT SAFETY INFORMATION.....	14
PARTS NAMES.....	15
OPERATION RANGE.....	15
HINTS FOR ECONOMICAL OPERATION.....	16
ADJUSTING AIR FLOW DIRECTION	16
MAINTENANCE.....	16
FOLLOWING SYMPTOMS ARE NOT AIR CONDITIONER TROUBLES.....	17
TROUBLESHOOTING.....	18

1. IMPORTANT SAFETY INFORMATION

To prevent injury to the user or other people and property damage, the following instructions must be followed. Incorrect operation due to ignoring of instructions may cause harm or damage.

The safety precautions listed are divided into two categories. In either case, important safety information is listed which must be read.



WARNING

Failure to observe a warning may result in death. The appliance shall be installed in accordance with national wiring regulations.



CAUTION

Failure to observe a caution may result in injury or damage to the equipment.



WARNING

Ask your dealer for installation of the air conditioner.

Incomplete installation performed by yourself may result in a water leakage, electric shock, and fire.

Ask your dealer for improvement, repair, and maintenance.

Incomplete improvement, repair, and maintenance may result in a water leakage, electric shock, and fire.

In order to avoid electric shock, fire or injury, or if you detect any abnormality such as smell of fire, turn off the power supply and call your dealer for instructions.

Never let the indoor unit or the remote controller get wet. It may cause an electric shock or a fire.

Never press the button of the remote controller with a hard, pointed object.

The remote controller may be damaged.

Never replace a fuse with that of wrong rated current or other wires when a fuse blows out.

Use of wire or copper wire may cause the unit to break down or cause a fire.

It is not good for your health to expose your body to the air flow for a long time.

Do not insert fingers, rods or other objects into the air inlet or outlet.

When the fan is rotating at high speed, it will cause injury.

Never use a flammable spray such as hair spray, lacquer or paint near the unit.

It may cause a fire.

Never touch the air outlet or the horizontal blades while the swing flap is in operation.

Fingers may become caught or the unit may break down.

Never put any objects into the air inlet or outlet.

Objects touching the fan at high speed can be dangerous.

Never inspect or service the unit by yourself.

Ask a qualified service person to perform this work.

Do not dispose this product as unsorted municipal waste. Collection of such waste separately for special treatment is necessary.

Do not dispose of electrical appliances as unsorted municipal waste, use separate collection facilities.

Contact your local government for information regarding the connection systems available.

To prevent water leak, contact your dealer.

When the system is installed and runs in a small room, it is required to keep the concentration of the water, if by any chance coming out, below the limit. the cool capacity would be lower.

Turn off any combustible heating devices, ventilate the room, and contact the dealer where you purchased the unit.

Do not use the air conditioner until a service person confirms that the portion where the refrigerant leaks is repaired.



CAUTION

Do not use the air conditioner for other purposes.

In order to avoid any quality deterioration, do not use the unit for cooling precision instruments, food, plants, animals or works of art.

Before cleaning, be sure to stop the operation, turn the breaker off or pull out the supply cord.

Otherwise, an electric shock and injury may result.

In order to avoid electric shock or fire, make sure that an earth leak detector is installed.

Be sure the air conditioner is grounded.

In order to avoid electric shock, make sure that the unit is grounded and that the earth wire is not connected to gas or water pipe, lightning conductor or telephone earth wire.

In order to avoid injury, do not remove the fan guard of the outdoor unit.

Do not operate the air conditioner with a wet hand.

An electric shock may happen.

Do not touch the heat exchanger fins.

These fins are sharp and could result in cutting injuries.

Do not place items which might be damaged by moisture under the indoor unit.

Condensation may form if the humidity is above 80%, the drain outlet is blocked or the filter is polluted.

After a long use, check the unit stand and fitting for damage.

If damaged, the unit may fall and result in injury.

To avoid oxygen deficiency, ventilate the room sufficiently if equipment with burner is used together with the air conditioner.

Arrange the drain hose to ensure smooth drainage.

Incomplete drainage may cause wetting of the building, furniture etc.

Never touch the internal parts of the controller.

Do not remove the front panel. Some parts inside are dangerous to touch, and a machine trouble may happen.

Never expose little children, plants or animals directly to the air flow.

Adverse influence to little children, animals and plants may result.

Do not allow a child to mount on the outdoor unit or avoid placing any object on it.

Falling or tumbling may result in injury.

Do not operate the air conditioner when using a room fumigation - type insecticide.

Failure to observe could cause the chemicals to become deposited in the unit, which could endanger the health of those who are hypersensitive to chemicals.

Do not place appliances which produce open fire in places exposed to the air flow from the unit or under the indoor unit.

It may cause incomplete combustion or deformation of the unit due to the heat.

Do not install the air conditioner at any place where flammable gas may leak out.

If the gas leaks out and stays around the air conditioner, a fire may break out.

The appliance is not intended for use by young children or infirm persons without supervision.

Young children should be supervised to ensure that they do not play with the appliance.



DISPOSAL: Do not dispose this product as unsorted municipal waste. Collection of such waste separately for special treatment is necessary.

- Do not dispose of electrical appliances as unsorted municipal waste, use separate collection facilities.
- Contact you local government for information regarding the collection systems available.

2. PARTS NAMES

The air conditioner consists of the indoor unit, the connecting pipe and the remote controller.

■ Function indicators on indoor unit display panel

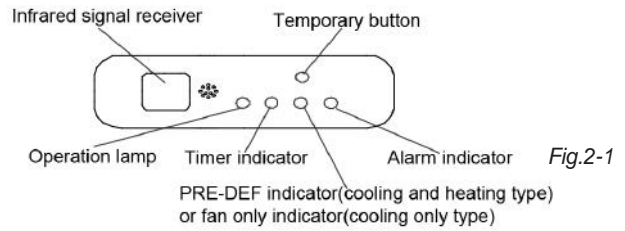

This function is used to operate the unit temporarily in case you misplace the remote controller or its batteries are exhausted. Two modes including AUTO and FORCED COOL can be selected through the TEMPORARY BUTTON. Once you push this button, the air conditioner will run in such order: AUTO, FORCED COOL, OFF, and back to AUTO.

- 1 **AUTO**
The OPERATION lamp is lit, and the air conditioner will run under AUTO mode. The remote controller operation is enabled to operate according to the received signal.
- 2 **FORCED COOL**
The OPERATION lamp flashes, the air conditioner will turn to AUTO after it is enforced to cool with a wind speed of HIGH for 30 minutes. The remote controller operation is disabled.
- 3 **OFF**
The OPERATION lamp goes off. The air conditioner is OFF while the remote controller operation is enabled.

3. OPERATION RANGE

Use the system in the following temperature for safe and effective operation.

Table 3-1

Temperature Mode	Outdoor temperature	Room temperature	water inlet temperature
Cooling operation	0°C~43°C	17°C~32°C	3°C~20°C
Heating operating	-15°C~24°C	0°C~30°C	30°C~70°C



NOTE

- 1 If air conditioner is used outside the above conditions, it may cause the unit to function abnormally.
- 2 The phenomenon is normal that the surface of air conditioning may condense water when the relative larger humidity in room, please close the door and window.
- 3 Optimum performance will be achieved within these operating temperature range.
- 4 In heating mode, the temperature of the inlet water must be under 75°C.
- 5 Water system operating pressuer: Max: 1.6MPa, Min: 0.15MPa.

4. HINTS FOR ECONOMICAL OPERATION

The following should be noticed to ensure an economical operation. (Refer to corresponding chapter for details)

- Adjust the air flow direction properly to avoid winding toward your body.
- Adjust the room temperature properly to get a comfortable situation and to avoid supercooling and superheat.
- In cooling, close the curtains to avoid direct sunlight.
- To keep cool or warm air in the room, never open doors or windows more often than necessary.
- Set the timer for the desired operating time.
- Never put obstructions near the air outlet or the air inlet. Or it will cause lower efficiency, even a sudden stop.
- Adjust the air flow direction properly to avoid winding toward your body.
- Adjust the room temperature properly to get a comfortable situation and to avoid supercooling and superheat.
- In cooling, close the curtains to avoid direct sunlight.
- To keep cool or warm air in the room, never open doors or windows more often than necessary.
- A clogged air filter will reduce cooling or heating efficiency, please clean it once two weeks.

5. ADJUSTING AIR FLOW DIRECTION

While the unit is in operation, you can adjust the air flow louver to change the flow direction and naturalize the room temperature evenly. Thus you can enjoy it more comfortably.

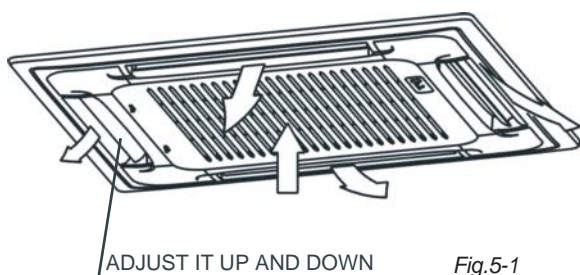

Fig.5-1

- **Set the air flow direction.**
Press the SWING button to adjust the louver to the desired position and press this button again to maintain the louver at this position.
- **Adjust the air flow direction automatically.**
Press the SWING button, the louver will swing automatically. While this function is set, the swing fan of indoor unit runs; otherwise, the swing fan doesn't run. The swing scale of every side is 30°. When the air conditioner isn't in operation (including when TIMER ON is set), the SWING button will be invalid.

6. MAINTENANCE



CAUTION

Before you clean the air conditioner, be sure the power supply is off.

Check if the wiring is not broken off or disconnected.

Use a dry cloth to wipe the indoor unit and remote controller.

A wet cloth may be used to clean the indoor unit if it is very dirty.

Never use a damp cloth on the remote controller.

Do not use a chemically-treated duster for wiping or leave such material on the unit for long. it may damage or fade the surface of the unit.

Do not use benzene, thinner, polishing powder, or similar solvents for cleaning. These may cause the plastic surface to crack or deform.

■ Maintenance after a long stop period

(eg. at the beginning of the season)

Check and remove everything that might be blocking inlet and outlet vents of indoor units and outdoor units.

Clean air filters and casings of indoor units. Refer to "Cleaning the air filter" for details on how to proceed and make sure to install cleaned air filters back in the same position.

Turn on the power at least 12 hours before operating the unit in order to ensure smoother operation. As soon as the power is turned on, the remote controller displays appear.

■ Maintenance before a long stop period

(eg. at the end of the season)

Let the indoor units run in fan only operation for about half a day in order to dry the interior of the units.

Clean air filters and casings of indoor units. Refer to "Cleaning the air filter" for details on how to proceed and make sure to install cleaned air filters back in the same position.

■ Cleaning the air filter

The air filter can prevent the dust or other particulate from going inside. In case of blockage of the filter, the working efficiency of the air conditioner may greatly decrease. Therefore, the filter must be cleaned once two weeks during long time usage.

If the air conditioner is installed in a dust place, clean the air filter frequent.

If the accumulated dust is too heavy to be cleaned, please replace the filter with a new one (replaceable air filter is an optional fitting).

The filter cleaning should be performed by a suitable service provider.

1 Open the air-in grill

Push the grill switches towards the middle simultaneously as indicated in Fig.6-1. Then pull down the air-in grill.

The control box cables ,which are originally connected with the main body electrical terminators must be pulled off before doing as indicated above.

2 Take out the air-in grill (together with the air filter shown in Fig.6-2).

Pull the air-in grill down at 45° and lift it up to take out the grill.

3 Dismantle the air filter.**4 Clean the air filter**

Vacuum cleaner or pure water may be used to clean the air filter.If the dust accumulation is too heavy , please use soft brush and mild detergent to clean it and dry out in cool place

- The air-in side should face up when using vacuum cleaner. (See Fig. 6-3)
- The air-in side should face down when using water. (See Fig. 6-4)

Caution : Do not dry out the air filter under direct sunshine or with fire.

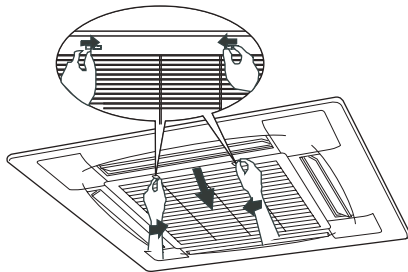

Fig.6-1

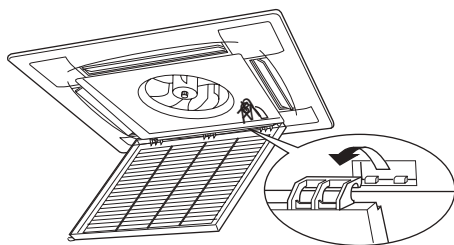

Fig.6-2

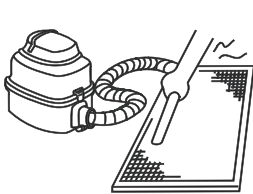

Fig.6-3

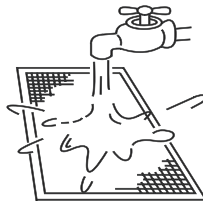

Fig.6-4

**CAUTION**

Do not dry out the air filter under direct sunshine or with fire.

5. Re-install the air filter.

6. Install and close the air-in grill in the reverse orders of step 1 and 2 and connect the control box cables to the corresponding terminators of the main body.

7. FOLLOWING SYMPTOMS ARE NOT AIR CONDITIONER TROUBLES**Symptom 1: The system does not operate**

- The air conditioner does not start immediately after the ON/OFF button on the remote controller is pressed. If the operation lamp lights, the system is in normal condition.To prevent overloading of the compressor motor, the air conditioner starts 3 minutes after it is turned ON.
- If the operation lamp and the "PRE-DEF indicator(cooling and heating type) or fan only indicator(cooling only type)" light, it means you choose the heating model. When just starting, if the compressor has not started, the indoor unit appears "anti cold wind" protection because of its overflow outlet temperature.

Symptom 2: Change into the fan mode during cooling mode

- In order to prevent the indoor evaporator frosting, the system will change into fan mode automatically, restore to the cooling mode after soon.
- When the room temperature drops to the set temperature, the compressor goes off and the indoor unit changes to fan mode; when the temperature rises up, the compressor starts again. It is same in the heating mode.

Symptom 3: White mist comes out of a unit

- When humidity is high during cooling operation If the interior of an indoor unit is extremely contaminated,the temperature distribution inside a room becomes uneven. It is necessary to clean the interior of the indoor unit.Ask your dealer for details on cleaning the unit.This operation requires a qualified service person.
- When the system is changed over to heating operation after defrost operation Moisture generated by defrost becomes steam and is exhausted.

Symptom 4: Noise of air conditioners cooling

- A continuous low "shah" sound is heard when the system is in cooling operation or at a stop. When the drain pump (optional accessories) is in operation,this noise is heard.
- A "pishi-pishi" squeaking sound is heard when the system stops after heating operation. Expansion and contraction of plastic parts caused by temperature change make this noise.
- When the tone of operating noise changes. This noise is caused by the change of frequency.

Symptom 5: Dust comes out of the unit

- When the unit is used for the first time in a long time. This is because dust has gotten into the unit.

Symptom 6: The units can give off odours

- The unit can absorb the smell of rooms, furniture, cigarettes, etc., and then emit it again.

8. TROUBLESHOOTING

8.1. Troubles and causes of air conditioner

If one of the following malfunctions occur, stop operation, shut off the power, and contact with your dealer.

- The operation lamp is flashing rapidly (twice every second)
This lamp is still flashing rapidly after turn off the power and turn on again.
- Remote controller receives malfunction or the button does not work well.
- A safety device such as a fuse, a breaker frequently actuates.
- Water leaks from indoor unit.
- Other malfunctions.

Table 8-1

Symptoms	Causes	Solution
Unit does not start	<ul style="list-style-type: none"> • Power failure. • Power switch is off. • Fuse of power switch may have burned. • Batteries of remote controller exhausted or other problem of controller. 	<ul style="list-style-type: none"> • Wait for the comeback of power. • Switch on the power. • Replace the fuse. • Replace the batteries or check the controller.
Air flowing normally but completely can't cooling	<ul style="list-style-type: none"> • Temperature is not set correctly. 	<ul style="list-style-type: none"> • Set the temperature properly.
Low cooling effect	<ul style="list-style-type: none"> • Indoor unit heat exchanger is dirty. • The air filter is dirty. • Inlet of indoor units is blocked. • Doors and windows are open • Sunlight directly shine. • Too much heat resource. • Outdoor temp. is too high. 	<ul style="list-style-type: none"> • Clean the heat exchanger. • Clean the air filter. • Eliminate all dirties and make air smooth. • Close doors and windows. • Make curtains in order to shelter from sunshine. • Reduce heat source. • AC cooling capacity reduces (normal).
Low heating effect	<ul style="list-style-type: none"> • Outdoor temperature is lower than 7°C . • Doors and windows not completely closed. 	<ul style="list-style-type: none"> • Use heating device. • Close doors and windows.

Table 8-2

NO.	Malfunction	Operation	Timer	Defrost	Alarm
1	Room temperature sensor checking channel is abnormal	×	☆	×	×
2	Evaporator sensor checking channel is abnormal	☆	×	×	×
3	EEPROM malfunction	☆	☆	×	×
4	Water-level switch malfunction	×	×	×	☆
5	Fan failure	☆	×	☆	×
6	ON/OFF switch	×	×	☆	×

(× Extinguish, ☆ Flash at 5Hz)

8.2. Troubles and causes of remote controller

Before asking for serving or repairing , check the following points.

Table 8-3

Symptoms	Causes	Solution
The fan speed can not be changed.	<ul style="list-style-type: none"> Check whether the MODE indicated on the display is "AUTO" 	When the automatic mode is selected, the air conditioner will automatically change the fan speed.
	<ul style="list-style-type: none"> Protection against hot wind in cooling mode. Protection against cold wind in heating mode. 	Reduce the temperature of inlet in cooling mode rise the temperature of inlet in heating mode.
The remote controller signal is not transmitted even when the ON/OFF button is pushed.	<ul style="list-style-type: none"> Check whether the batteries in the remote controller are exhausted. 	The power supply is off.
The TEMP. indicator does not come on.	<ul style="list-style-type: none"> Check whether the MODE indicated on the display is FAN ONLY 	The temperature cannot be set during FAN mode.
The indication on the display disappears after a lapse of time.	<ul style="list-style-type: none"> Check whether the timer operation has come to an end when the TIMER OFF is indicated on the display. 	The air conditioner operation will stop up to the set time
The TIMER ON indicator goes off after a lapse of certain time.	<ul style="list-style-type: none"> Check whether the timer operation is started when the TIMER ON is indicated on the display. 	Up to the set time, the air conditioner will automatically start and the appropriate indicator will go off.
No receiving tone sounds from the indoor unit even when the ON/OFF button is pressed.	<ul style="list-style-type: none"> Check whether the signal transmitter of the remote controller is properly directed to the infrared signal receiver of the indoor unit when the ON/OFF button is pressed. 	Directly transmit the signal transmitter of the remote controller to the infrared signal receiver of the indoor unit, and then repeatly push the ON/OFF button twice.

REMOTE CONTROLLER

Please read this manual carefully before installing and using the unit.

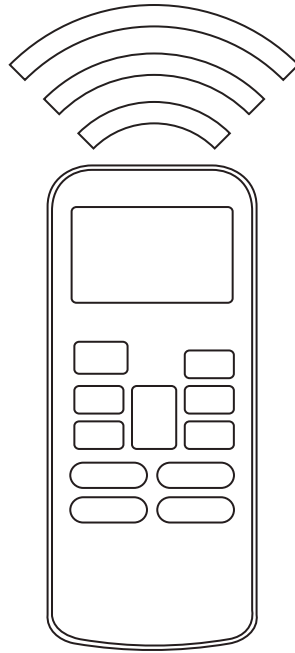

Safety precautions

The following contents are stated on the product and the operation manual, including usage, precautions against personal harm and property loss, and the methods of using the product correctly and safely. After fully understanding the following contents (identifiers and icons), read the text body and observe the following rules.

■ Identifier description

Identifier	Meaning
Warning	Means improper handling may lead to personal death or severe injury.
Caution	Means improper handling may lead to personal injury or property loss.
[Note]: 1. "Harm" means injury, burn and electric shock which need long-term treatment but need no hospitalization. 2. "Property loss" means loss of properties and materials.	

■ Icon description

Icon	Meaning
	It indicates forbidding. The forbidden subject-matter is indicated in the icon or by images or characters aside.
	It indicates compulsory implementation. The compulsory subject-matter is indicated in the icon or by images or characters aside.

	Delegate installation	Please entrust the distributor or professionals to install the unit. The installers must have the relevant know-how. Improper installation performed by the user without permission may cause fire, electric, shock, personal injury or water leakage.
--	-----------------------	--

	Forbid	Do not spray flammable aerosol to the wire controller directly. Otherwise, fire may occur.
	Forbid	Do not operate with wet hands or let water enter the wire controller. Otherwise, electric shock may occur.

1. Wireless remote controller RM05

- This manual gives detailed description of the precautions that should be brought to your attention during operation.
 - In order to ensure correct service of the wired remote unit.
 - For convenience of future reference, keep this manual after reading it.
- Curtain, door or the like objects will prevent the remote signal from being received by air conditioner.
- Do not get the interior of remote controller wet. It is forbidden to expose it to direct sunlight or locate it in the place with high temp.
- Malfunction may occur if infrared signal receiver on air conditioner is exposed to sunlight. Please shelter the signal receiver from sunlight with curtain.

- Please remove the nearby electronic device for they may affect the performance of remote controller. If necessary, contact the local Midea service centre or technical support centre.
- Do not put the used or different batteries into the remote controller, otherwise remote controller will fail to send signal.
- Please remove the batteries before long period unused, otherwise the remote controller may be damaged.
- If pressing the button reset the remote controller, which indicates low battery, please replace the batteries.
- If no receiving sound is heard from indoor unit or on remote controller does not flash, please replace the batteries.
- Effective transmitting distance of remote controller is 8m, please aim the signal sending part to the receiver on air conditioner.

1.1. Model and specification

Model	R05/BGE
Rated voltage	3.0V(2 pieces of LR03 7# batteries)
Min voltage for sending signal of CPU	2.4V
Effective receiving distance	8m~11m
Operation condition	-5~60°C

1.2. Buttons and their functions

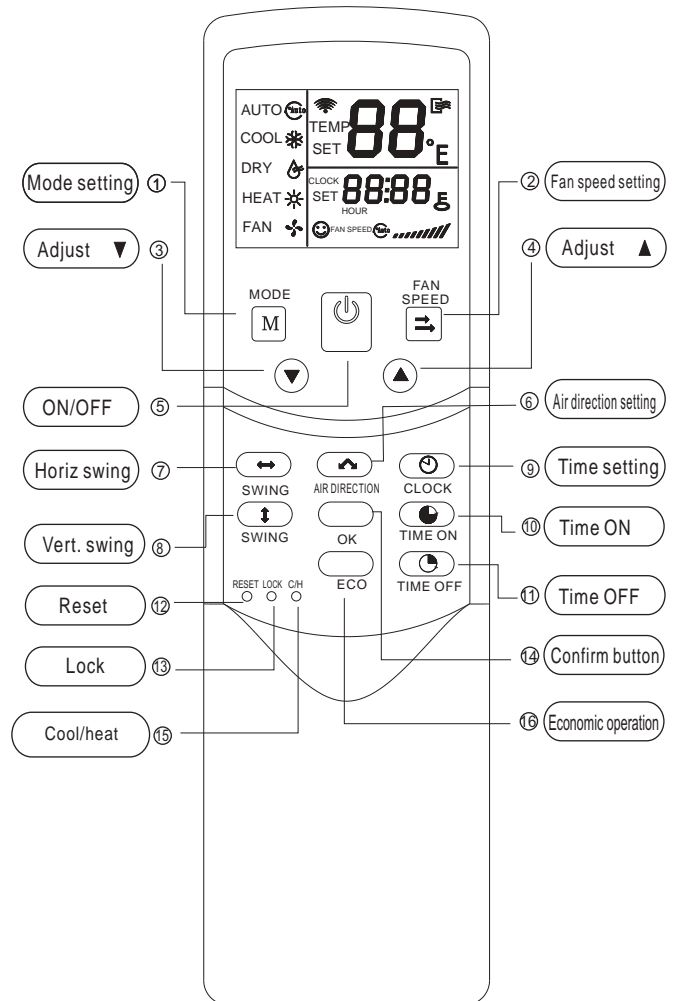

Chart 1

MODE: Once pressing, running mode will be selected in the following sequence:



NOTE: No heating mode for cool only type unit.

FAN SPEED: Fan speed will be selected in following sequence once pressing this button:



Adjust▼: Decrease the set temp. Keeping pressing will decrease the temp with 1 per 0.5s.

④ Adjust▲: Increase the set temp. Keeping pressing will increase the temp with 1 per 0.5s.

ON/OFF: For turning on or turning off the air conditioner.

AIR DIRECTION: Activate swing function of air deflector. Once pressing, air deflector will turn 6°. For normal operation and better cooling and heating effect, deflector will not turn to the degree which is the state of deflector when the unit is turned off. (Only available when remote controller is used with corresponding unit.)

HORIZ SWING: Activate or turn off horizontal swing function. (Only available when remote controller is used with corresponding unit.)

VERT SWING: Activate or turn off vertical swing function. (Only available when remote controller is used with corresponding unit.)

CLOCK: Display the current time. (12:00 is displayed when resetting or electrifying for the first time.) Press CLOCK for 5s, icon indicating hour will flash with 0.5s. Press it again, icon indicating minute will flash with 0.5s. ▼ and▲ are used to adjust the figure. Setting or modification is effective only by pressing OK button to make confirmation.

TIME ON: For time ON setting. Once pressing this button, the time will increase by 0.5 hour. When the set time exceeds 10 hours, pressing the button will increase the time by 1 hour. Adjusting the figure to 0.00 will cancel time ON setting.

⑪ TIME OFF: For time OFF setting. Once pressing this button, the time will increase by 0.5 hour. When the set time exceeds 10 hours, pressing the button will increase the time by 1 hour. Adjust the figure to 0.00 will cancel time ON setting.

⑫ RESET (inner located): Press this button with a needle of 1mm to cancel the current setting and reset remote controller.

⑬ LOCK (inner located): Press this button with a needle of 1mm to lock or unlock the current setting.

⑭ OK: Used to confirm the time setting and modification.

⑮ COOL/HEAT (inner located): Press this button with a needle of 1mm to shift mode between COOL only and COOL&HEAT. During setting, back light will be lightened. Factory default mode is COOL &HEAT.

⑯ ECO: Activate or turn off economic operation mode. It is suggested to turn on this function when sleeping. (Only available when remote controller is used with corresponding unit.)

1.3. Names of indicators and their functions

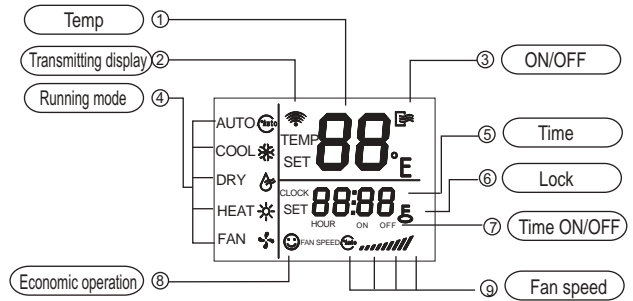

Chart 2

Temp: Display the set temperature. Adjust temperature via▲ and▼. No display in this area if the unit is on FAN mode.

Transmitting display: The icon will flash once when the signal is sent by remote controller.

ON/OFF: Icon is displayed when the remote controller is turned on, or vice versa.

④ Running mode: Press MODE to display current running mode. AUTO, COOL, DRY, HEAT and FAN can be selected. (HEAT function is invalid for cool only type unit.)

Time: Display the current set time. Press CLOCK for 5s, icon indicating hour will flash. Press this button again, icon indicating minute will flash.▲ And▼ are used to adjust the figure. Setting or modification is effective only by pressing OK button to make confirmation.

Lock: The icon will be lightened or off when pressing LOCK. In locked state, all the buttons are ineffective except button LOCK.

Time ON/OFF: In the state of time ON, icon ON will be lightened, which is the same to the state of time OFF. Setting timer ON and OFF simultaneously, both icons ON and OFF are displayed.

Fan speed: Press FAN SPEED to display the current wind speed. AUTO, LOW, MED and HIGH can be selected. The default state is high fan speed for the unit without medium fan speed.

Economic operation: This icon will be lightened or off when pressing ECO button.

NOTE: All the above icons will be displayed only when the remote controller is electrified for the first time or reset.

1.4. Operation instructions

Install and replace batteries

- Install 2 pieces of 7# alkaline batteries.
- Slide the cover to install batteries and make sure to place them in right pole.

AUTO operation

Switch on the power and running indicator light on indoor unit flashes.

1. Press MODE to select AUTO.
2. Adjust temp via ▲ and ▼. Generally the range is 17 ~30 .
3. Press ON/OFF and running indicator light on indoor unit is lightened. Air conditioner will work on AUTO mode and fan speed is AUTO which is nonadjustable.
4. ECO is effective on AUTO operation.

COOL/HEAT/FAN operation

1. Press MODE to select COOL, HEAT or FAN.
2. Adjust temp via ▲ and ▼. Generally the range is 17 ~30 .
3. Press FAN SPEED to select AUTO, LOW, MED or HIGH.
4. Press ON/OFF and running indicator light on indoor unit is lightened. Air conditioner will work on the set mode. Stop operation via ON/OFF.

ineffective. Procedure 2 is omitted.

DRY operation

1. Press MODE to select DRY.
2. Adjust temp via ▲ and ▼. Generally the range is 17 ~30 .
3. Press ON/OFF and running indicator light on indoor unit is lightened. Air conditioner will work on DRY mode. Turn off the unit via ON/OFF.
4. On DRY mode, ECO and FAN SPEED are unavailable.

Timer operation

TIME ON and TIME OFF are used to turn on and turn off the unit at the set time respectively.

☛ TIME ON operation

1. Press TIME ON, icon SET, HOUR and ON are lightened.
2. Press TIME ON again and adjust the time.
3. Keep pressing this button, the time will increase by 0.5 hour. When the set time exceeds 10 hours, pressing the button will increase the time by 1 hour.
4. 0.5s after setting, remote controller will send TIME ON command to the unit.

☛ TIME OFF operation

1. Press TIME OFF, icon SET, HOUR and OFF are lightened.
2. Press TIME OFF again and adjust the time.
3. Keep pressing this button, the time will increase by 0.5 hour. When the set time exceeds 10 hours, pressing the button will increase the time by 1 hour.
4. 0.5s after setting, remote controller will send TIME OFF command to the unit.

☛ Set TIME ON and TIME OFF simultaneously

1. Set TIME ON according to procedures 1 and 2 specified in **TIME ON operation**.
2. Set TIME OFF as the procedures 1 and 2 specified in **TIME OFF operation**.
3. If both the set time of TIME ON and TIME OFF not exceed 10 hours, time OFF operation will activated 0.5 hour later than time ON operation. If both the set time of TIME ON and TIME OFF exceed 10 hours, time OFF operation will be activated 1 hour later than time ON operation.
4. 0.5s after setting, remote controller will send TIME ON command to the unit.

☛ Modification of timer operation

Press corresponding button and readjust the time of time ON and time OFF. Adjust the time figure to 0.00 to cancel the timer operation.

NOTE: The time set in timer operation is the relative figure based on the clock on remote controller. Adjusting clock is unavailable when TIME ON or TIME OFF is activated.

2. Wireless remote controller RM02A

- The outline figure on cover is for reference only, which may differ from what you purchased.
- Make sure to read chapter PRECAUTIONS before you operate the air conditioner.
- This manual is available for model RM02A/BGE-A and RM02A/BGE(T)-A.

2.1. Model and specification

Model	RM02A/BGE-A RM02A/BGE(T)-A
Rated voltage	3.0V(2 pieces of LR03 7# batteries)
Min voltage for sending signal of CPU	2.0V
Effective receiving distance	8m(Where is 3.0V,that will be 11m)
Operation condition	-5~60°C

2.2. Buttons and their functions

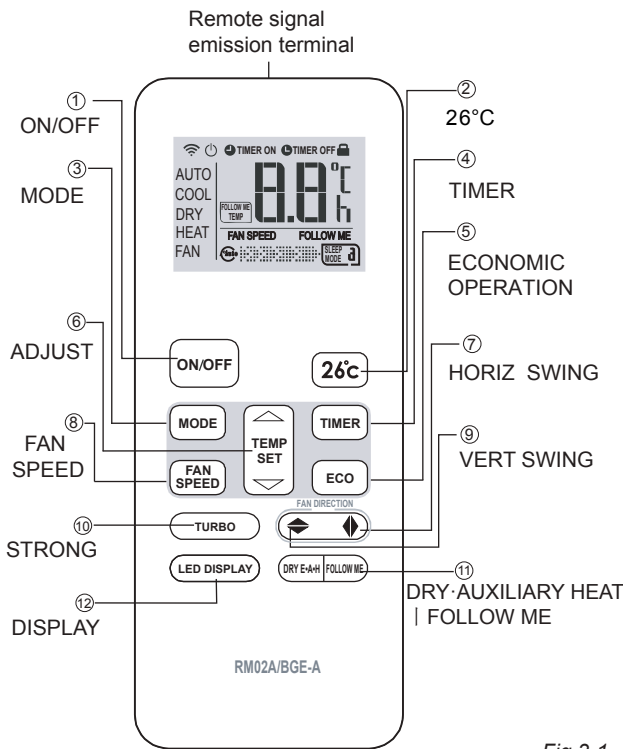
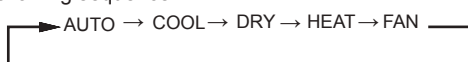

Fig.3-1

- ① ON/OFF: For turning on or turning off the air conditioner.
- ② 26°C: Press this button, can operate the cool mode with the setting temperature 26°C.
- ③ MODE: Once pressing, running mode will be selected in the following sequence:



- ④ TIMER:
 - Under the OFF state, press this button, TIMER ON are lightened. continue to press TIMER button, the time will increase by 0.5 hour. When the set time exceeds 10 hours, pressing TIMER button will increase the time by 1 hour. Adjust the TIMER ON to be "0:00" then can cancel the TIMER ON.
 - Under the ON state, press this button, TIMER OFF are lightened. and continue to press TIMER button, the time will increase by 0.5 hour. When the set time exceeds 10 hours, pressing TIMER button will increase the time by 1 hour. Adjust the TIMER OFF to be "0:00" then can cancel the TIMER OFF.
- ⑤ ECO: Activate or turn off economic operation mode.
- ⑥ ADJUST ▾ : Decrease the set temp. Keeping pressing will decrease the temp with 1°C per 0.5s.
 ADJUST ▲ : Increase the set temp. Keeping pressing will increase the temp with 1°C per 0.5s.
- ⑦ HORIZ SWING: Activate or turn off wind horizontal swing function. (Only available when remote controller is used with corresponding unit.)
- ⑧ FAN SPEED:
 - Fan speed will be selected in following sequence once pressing this button: (Under the DRY and AUTO mode (except for the auto heat recycling mode), the fan speed will be fixed and can not be adjusted. Under the auto heat recycling mode, the fan speed will be automatically and can be adjusted.)

Sequence: AUTO → LOW → MED → HIGH
- ⑨ VERT SWING: Activate or turn off wind vertical swing function. Under the power off state, this button will not work. (Only available when remote controller is used with corresponding unit.)
- ⑩ STRONG:
 - Press this button, set the air conditioner to operate as strong mode, and the frequency will be raised, press again will cancel this mode. (Only available when remote controller is used with corresponding unit.)
- ⑪ DRY·AUXILIARY HEAT | FOLLOW ME:
 - Press the left of the button when it is operating the dry cleaning function, will close the dry cleaning function; press the right of the button when it is operating follow me function, will close the follow me function. (Only available when remote controller is used with corresponding unit.)
- ⑫ DISPLAY:
 - When the air conditioner is on the ON state, press this button, can close (open) the modules display, press again will open (close) the display. (Only available when remote controller is used with corresponding unit.)

2.3. Names of indicators and their functions

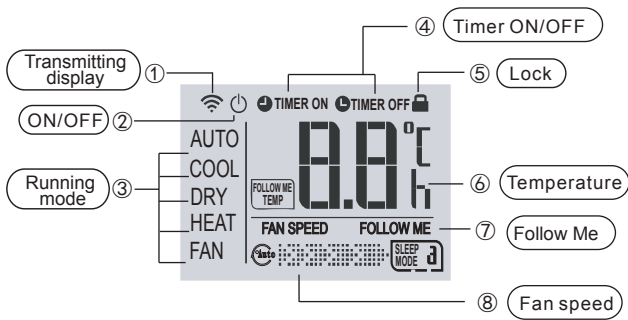

Fig.4-1

- ① Transmitting display: The icon will flash once when the signal is sent by remote controller.
- ② ON/OFF: Icon is displayed when the remote controller is turned on, or vice versa.
- ③ Running mode: Press MODE to display current running mode. AUTO, COOL, DRY, HEAT and FAN can be selected.
- ④ Timing ON/OFF: When adjusting timing ON state or only the timing ON function has been set, the "Timing ON" will be displayed; when adjusting timing OFF state or only the timing OFF function has been set, the "Timing OFF" will be displayed.
- ⑤ Lock: Press MODE and TIMER button for 5s simultaneously, lock icon will be displayed; Press buttons again, the icon disappears.
- ⑥ Temperature: Display the set temperature. Adjust temperature via "▲, ▼". No display in this area if the unit is on FAN mode.
- ⑦ Follow Me: Under the cool, heat, auto mode operation state, press the right of "DRY E•A•H | FOLLOW ME" button, the follow me icon will be displayed, and press again the icon will be disappeared.
- ⑧ Fan speed: Press FAN SPEED to display the current wind speed. AUTO, LOW, MED and HIGH can be selected. The default state is high fan speed for the unit without medium fan speed.



CAUTION

All the above icons are listed for instruction, and the relative items will be displayed when operation. And all the icons will be displayed when the remote controller is electrified for the first time or reset.

2.4. Operation instructions

2.4.1. Install and replace batteries

1. Install 2 pieces of 7# alkaline batteries.
2. Slide the cover to install batteries and make sure to place them in right pole.

2.4.2. Auto operation (Normal)

AUTO operation

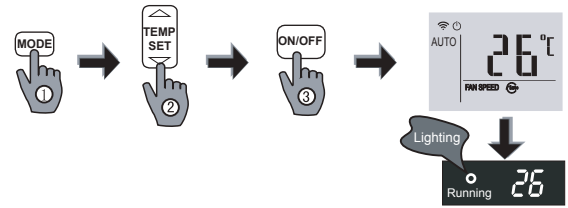

Fig.5-1

1. Press MODE to select AUTO.
2. Adjust temp via ▲ and ▼. Generally the range is 17°C~30°C.
3. Press ON/OFF and running indicator light on indoor unit is lightened. Air conditioner will work on AUTO mode and fan speed is AUTO, the display screen on remote controller will display "AUTO", then the fan speed is adjustable. And press ON/OFF again, the air conditioner will be stopped.

2.4.3. Dry / Fan / Cool / Heat operation

DRY/FAN/COOL/HEAT OPERATION

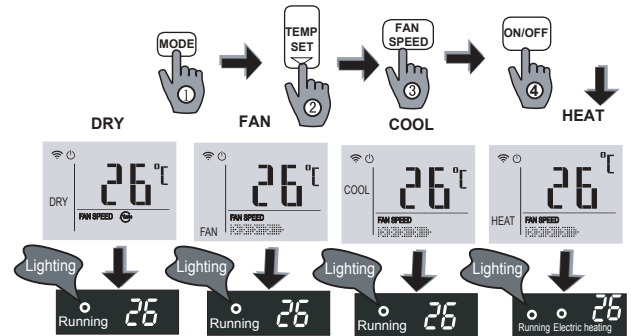

Fig.5-2

1. Press MODE to select COOL, DRY, HEAT or FAN.
2. Adjust temp via ▲ and ▼. Generally the range is 17°C~30°C.
3. Press FAN SPEED to select AUTO, LOW, MED or HIGH.
4. Press ON/OFF and running indicator light on indoor unit is lightened. Air conditioner will work on the set mode. Stop operation via ON/OFF.



CAUTION

"FAN" operation can not set the temperature, when select this operation only can do 1,3,4 steps.
 "DRY" operation can not set the fan speed, when select this operation only can do 1,2,4 steps.

2.4.4. Other function operation

Dry function

Function instruction

This air conditioner has dry function, close the unit under the cool and dry mode, the air conditioner will operate the dry function automatically, then the icon will be lightened. For cool-only model, the air conditioner will Low operate with fan mode for 10 mins and then close the unit automatically.

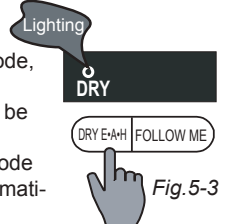

Fig.5-3

Stop operation

If you want to stop the dry function, can press the left of "DRY E•A•H | FOLLOW ME" under the function is operating, then can stop the function, and the icon will be off.

Follow me function

● **Function instruction**

This air conditioner has follow me function, when this function is operated, the remote controller will detect the temperature near the remote controller and compare with the temperature you set automatically, and control the operation of the air conditioner according to the contrastive result, and make the temperature near the remote controller reaches the setting temperature. This function is valid only under COOL, HEAT, AUTO mode and the unit has follow me function.

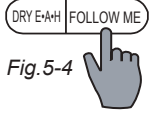

Fig.5-4

- The remote controller can not be placed near the heat source or low temperature source, otherwise will affect its temperature gathering precision and then affect the follow me function.

Strong operation function

● **Function instruction**

When operating cooling, press the "TURBO" button and operate the strong cooling operation, at the same time raise the frequency, press again will close the strong operation.

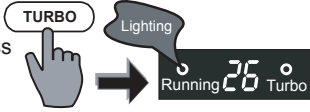

Fig.5-5

- This function is invalid under operating sleep function.

Energy-saving function

● **Function instruction**

When operating COOL/AUTO, press the "ECO" button, and operate power save function; press again will cancel the function.

- Under the DRY/FAN mode, this function is invalid.
- Under power save state, press "MODE", "ON/OFF" or "FAN" button will cancel this function.

Display function

● **Function instruction**

For avoiding the display light of the indoor unit will affect customer's rest, this unit has special display function. When the air conditioner is operated, press the "DISPLAY" button, then can close(open) the module display, press again can open (close) the display.

26°C green function

● **Function instruction**

Press "26°C" on the remote controller can operate the cooling operating mode with the setting temperature of 26°C.



Fig.5-6

Lock function

● **Function instruction**

Press the "MODE" and "TIMER" button at the same time and last over 5s, then can operate locking the remote controller. In locked state, all the buttons are ineffective. Press the "MODE" and "TIMER" button again at the same time and last over 2s, then can close the locking.

Auto heat recycling mode function

● **Function instruction**

ΔT : Temperature difference, means the different temperature between the indoor temperature (T_f) detected by the remote controller and the remote controller setting temperature (T_s). (the default difference is 3°C, the difference range is 1~4°C)

ΔT instruction

press \wedge and ∇ buttons for 5S simultaneously, then enter ΔT setting state.



SW1 definition

SW1 ON 1 2	Auto heat recycling Mode
SW1 ON 1 2	Auto Mode (Normal)

press \wedge or ∇ button adjust ΔT you want

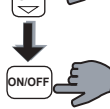

press ON/OFF button confirm and exit the setting

Example:

ΔT is 1°C, T_s is 25°C.

when $T_f - T_s \geq +\Delta T$, it will operate COOL mode, the fan speed will be operated according to the setting fan speed.
when $T_f - T_s \leq -\Delta T$, it will operate HEAT mode, the fan speed will be operated according to the setting fan speed.

Note:

This function operations only available when the indoor unit is in the heat recycling three-pipe system.

When the remote controller selects the auto heat recycling-mode, the remote controller position must be placed at the signal receiving range of the air conditioner.

When the remote controller detects changes of the mode(cool to heat, or heat to cool), it will send the changes to air conditioner. One beep of air conditioner changed mode signals is giving out.



CAUTION

5.4 Other functions operations only available when the indoor unit has corresponding functions.

2.4.5. Timer operation

Setting timing ON

Timing Setting

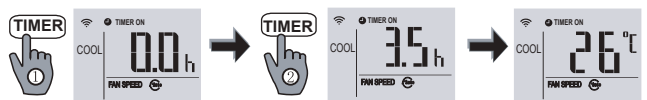

Fig.5-7

1. Under the remote controller is OFF, press the "TIMER" button, then the remote controller will display the timing ON icon and number display area will show up last timing ON time, and will display icon "h". The remote controller enters to the timing ON adjusting state.
2. (Continue) Press "TIMER" button, then can adjust the timing ON time to what you want.
3. After adjustment, the remote controller transmit the timing ON signal, and after 5s the icon "h" will be disappeared, and the number display area will back to display temperature, then finish the timing ON setting.

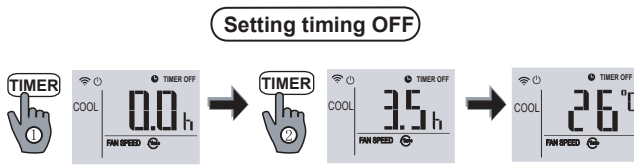

Fig.5-8

1. Under the remote controller is ON, press the “TIMER” button, then the remote controller will display the timing OFF icon and number display area will show up last timing OFF time, and will display icon “h”. The remote controller enters to the timing OFF adjusting state.
2. (Continue) Press “TIMER” button, then can adjust the timing OFF time to what you want.
3. After adjustment, the remote controller transmit the timing OFF signal, and after 5s the icon “h” will be disappeared, and the number display area will back to display temperature, then finish the timing OFF setting.

- Check the preset time of timing: press the corresponding timing button once, then will display the timing time.
- Change the timing ON or OFF time: press the corresponding timing button, then reset timing ON or OFF time.
- Cancel the timing: adjust the timing ON or OFF time to be 0.
- Timing the time to be relative time, that relate to the time which later than the standard time of operating the remote controller.
- Under the remote controller is ON, only can set timing OFF; under the remote controller is OFF, only can set timing ON.

Precautions

- Curtain, door or the like objects will prevent the remote signal from being received by air conditioner.
- Do not get the interior of remote controller wet. It is forbidden to expose it to direct sunlight or locate it in the place with high temp.
- Malfunction may occur if infrared signal receiver on air conditioner is exposed to sunlight. Please shelter the signal receiver from sunlight with curtain.
- Please remove the nearby electronic device for they may affect the performance of remote controller.
- Do not put the used or different batteries into the remote controller, otherwise remote controller will fail to send signal.
- Please remove the batteries before long period unused, otherwise the remote controller may be damaged.
- If pressing the button reset the remote controller, which indicates low battery, please replace the batteries.
- If no receiving sound is heard from indoor unit or on remote controller does not flash, please replace the batteries.
- Effective transmitting distance of remote controller is 8m, please aim the signal sending part to the receiver on air conditioner.

3. Wired remote controller KJR-29B

- This manual gives detailed description of the precautions that should be brought to your attention during operation.
- In order to ensure correct service of the wired remote controller please read this manual carefully before using the unit.
- For convenience of future reference, keep this manual after reading it.

3.1. Model and specification

● **Main parameters**

Table 2-1

Input voltage	DC +5V
Ambient temperature	-5~43℃
Ambient humidity	RH40%~RH90%

● **Functions**

Main functions of this wired remote controller as follows:

- 1.Connect with indoor unit via the four ports of A, B, C, D.
- 2.Set operation mode via buttons.
- 3.Provided with LCD display function.
- 4.Provided with timing function.

3.2. Wired remote controller outlook



3.3. Operation instructions

● **Remote signal receiving function**

The wired remote controller can be a remote signal receiving device, you can use the wireless remote controller to control the air-conditioner through the the wired remote controller when the system have been powerdon.

**CAUTION**

The wired remote controller will not receive the swing controlling instruction.

For the indoor unit with swinging function, you can directly use the wireless remote controller to control swinging through the display panel of the indoor unit, or use the swing button on the wired remote controller to control the indoor unit for swinging.

● On and Off the air-conditioner

Press the On/Off button to control the indoor unit on and off status.

When the unit is turned off, press the ON/OFF button, the unit will be turned on and the operating icon lights up.

When the unit is turned on, press the ON/OFF button, the unit will be turned off and the operation icon lights off.

● Set the operating mode

Press the mode button to set the operating mode, after each button press the operation mode will circle as follow:

AUTO→COOL→DRY→HEAT→FAN→AUTO

When the controller has been set to cool-only, then there is no HEAT mode.

● Fan speed setting

Under COOL, HEAT and FAN modes, press the fan speed button can adjust the fan speed setting.

After each fan speed button press will circle as follow:

AUTO→LOW→MID→HIGH→AUTO.

Under AUTO and DRY modes the fan speed is not adjustable and the default fan speed is auto.

● Temperature setting

Under AUTO, COOL, DRY, HEAT modes, press the temperature setting buttons and to set the temperature, the adjusting range is 17 °C~30 °C

The setting temperature cannot be adjusted under FAN mode.

● Timer on and Timer off setting

Press the timer/clock setting button, then enter into the timer on setting status, and the screen will display and .

Press and buttons to adjust the timer. when the timer setting is less than 10 hours, each press or will increase or decrease 0.5 hour. When the timer setting is more than 10 hours, each press or will increase or decrease 1 hour, the maximum timer setting is 24 hours.

After finish adjusting the timer on setting, press the button or wait for 5 seconds to confirm and exit the timer on setting.

Under the timer on setting status, press the timer/clock setting button, then enter into the timer off setting status, and the screen will display and .

The setting method of timer off is the same as the timer on.

Under timer setting state, set the timer on and timer off to be 0.0h can cancel timer on and timer off.

**CAUTION**

If the wired remote controller has been set timer on/off press the ON/OFF to turn on/ turn off the unit then the timer will be canceled simultaneously.

● Clock setting

Long press the timer/clock setting button for 3 seconds, then enter into the clock setting status.

The hour position of the clock will flash, and can press and to adjust the hour value.

After finishing the hour setting, press left button or right button to switch to minute position setting, then the minute position will flash, press and to adjust the minute value.

After finish the clock setting, press the button or wait for 5 seconds to confirm and exit the setting state.

● Quiet operation

Under COOL, HEAT, FAN modes, press the button to set into the quiet operation, it is used to reduce the running noise through setting the fan speed to low.

Under AUTO, DRY mode, the fan speed is auto and the button doesn't work.

● Lock the wired remote controller

Press the temperature adjusting buttons and simultaneously, the wired remote controller enters into locking state, and the lock icon will be lighted up.

Under the locking state, the wired remote controller will not respond to the buttons pressing and the control instruction from the wireless remote controller.

Simultaneously press the and temperature adjusting buttons and again can cancel the locking state.

• Air filter cleaning reminding function

The wired remote controller records the total running time of the indoor unit, when the accumulated running  time reaches the pre-setted value, the air filter of the indoor unit need to be cleaned.



Long press  for 3 seconds, and reset the reminding icon and the wired remote controller will re-accumulate the total running time of the indoor unit.



CAUTION

The default setting value of the reminding function is 2500 hours, and it can change to be 1250 hours, 5000 hours or 10000 hours. The setting methods please refer to the installation manual.

• Swing Function

If the indoor unit supports swing function, press the right button  to adjust the air outlet direction of the indoor unit. Long press this button for 3 seconds can turn on or turn off the auto swing function, the auto swing function, the swing icon  will be lighted up when the auto swing function is turned on.

• Follow Me function

When the system is running and the operating mode is AUTO, COOL or HEAT, press the  button will activate the Follow Me function, press the button again to deactivate the function. Operating mode changeover will deactivate the function as well.

when the Follow Me function is activated, the icon  will be light up, the wired controller will display room temperature read from the local sensor,, and transmit the temperature value to the indoor unit every 3 minutes.

MUNDO  CLIMA®



www.mundoclima.com

ASK FOR MORE INFORMATION

Phone: (+34) 93 446 27 81

eMail: info@mundoclima.com

TECHNICAL ASSISTANCE

Phone: (+34) 93 652 53 57