



# OUTDOOR UNIT

Service manual

## MAXI MVD V5X



# Content

1. General Information .....	1
2. Selection Procedure.....	10
3. Specifications & Performance .....	16
4. Installation .....	121
5. Troubleshooting .....	170

# Part 1 General Information

1. Features.....	2
2. Outdoor units .....	6
3. Indoor units lineup.....	8
4. Nomenclature .....	9

## 1. Features

### 1.1 Energy saving

V5 X Series achieves the industry's top class energy efficiency of cooling and heating by utilizing DC compressor control, DC Fan motor and improved performance heat exchanger.

#### 1.1.1 High efficiency DC inverter compressor

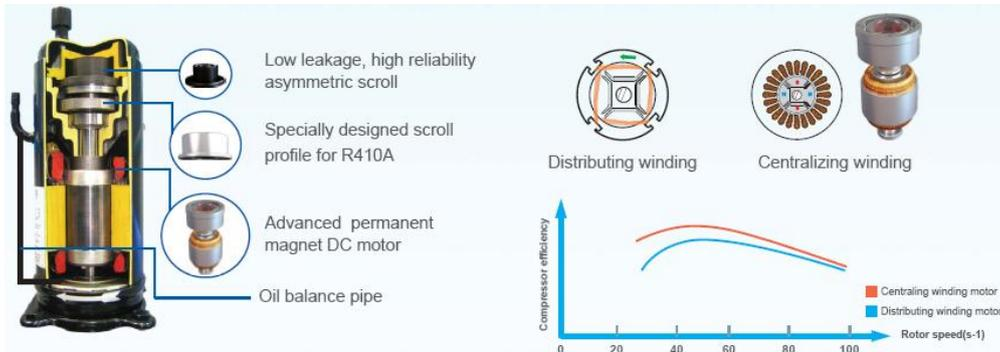

#### 1.1.2 High efficiency DC fan motor

According to the running load and system pressure, the system controls the speed of DC fan to achieve the minimum energy consumption and best performance.

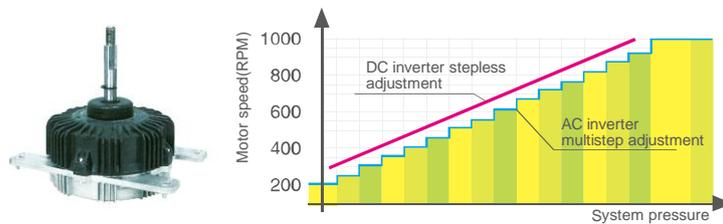

#### 1.1.3 High efficiency heat exchanger

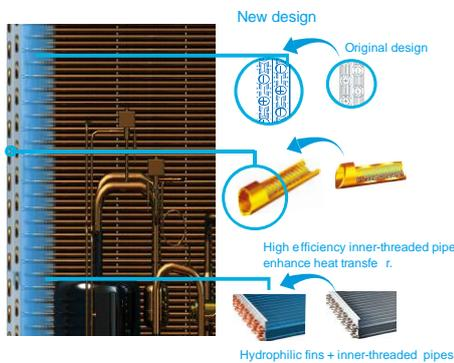

The new designed window fins enlarge the heat-exchanging area, decrease the air resistance, save more power and enhance heat exchange performance. Hydrophilic film fins and inner-threaded copper pipes optimize heat exchange efficiency.

## 1.2 Flexible design

### 1.2.1 Wide capacity range

The outdoor units' capacity range is from 8HP to 88HP in 2HP increment. Maximum 64 indoor units with capacity up to 130% of total outdoor units can be connected in one refrigeration system.

### 1.2.2 Wide operation range

The V5 X series system operates stably at extreme temperatures ranging from -20°C(-4°F) to 48°C(118.4°F).

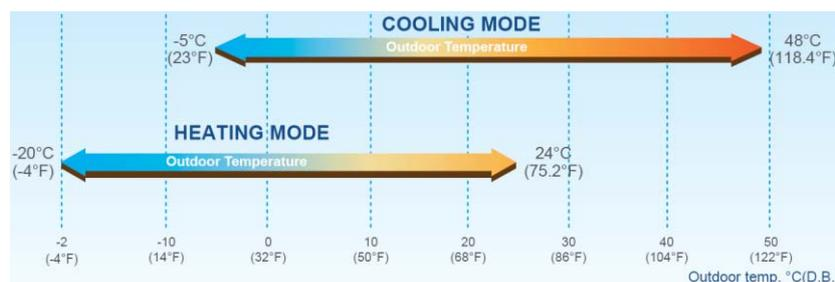

### 1.2.3 Flexible piping design

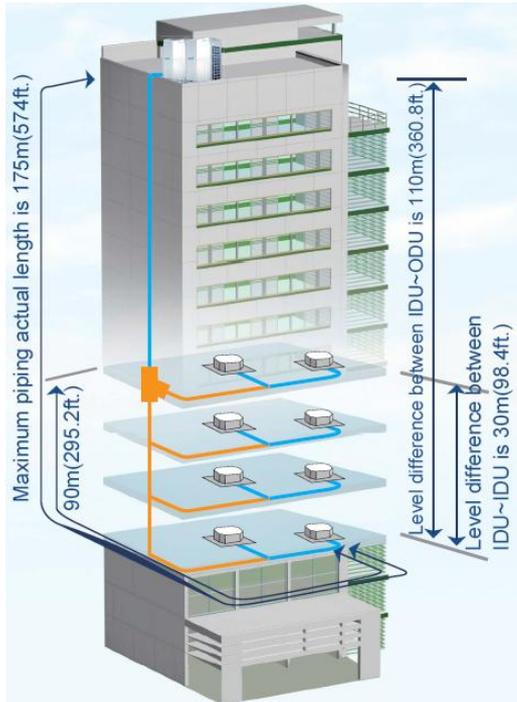

Piping length	Permitted value ft. (m)
Total pipe length	3280(1000)
Max. actual pipe length	574(175)
Max. equivalent pipe length	656(200)
Equivalent pipe length from the first indoor branch to the farthest indoor unit	131.2/295.2*(40/90*)
Level difference between outdoor unit and indoor unit	Outdoor unit is down: 360.8(110) Outdoor unit is up: 295.2(90)
Level difference between indoor units	98.4(30)

\* When the equivalent pipe length from the first indoor branch to the farthest indoor unit is more than 40m, it needs to meet the specific conditions according to the installation part of the technical manual.

### 1.2.4 High external static pressure

High-static pressure propeller and optimized fan guard can adapt to various installation environments. V5 X Series units offer up to 60Pa external static pressure for customized applications. A standard 0-20Pa function is equipped by default.

### 1.3 High reliability

#### 1.3.1 Cycle duty operation

In one combination, any outdoor unit can run as the master outdoor unit to equalize the service life of all units.

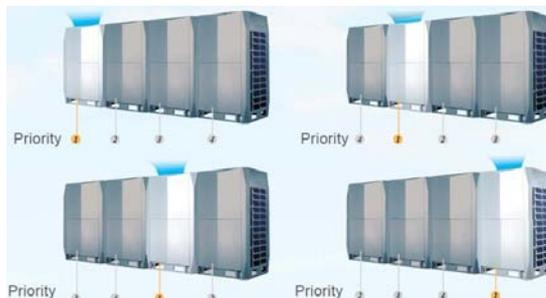

#### 1.3.2 Back-up function

In a multiple system, when the master unit failed, any single unit can be set as the master unit, and then the remaining units can keep on working. This can be set on PCB by DIP switch at site.

#### 1.3.3 Precise oil control technology

5-stage oil control technology ensures every outdoor unit & compressor's oil always keep in the safe level, completely solve the compressor oil lack problem.

- 1st stage: compressor internal oil separate
- 2nd stage: high efficiency oil separator (separation efficiency up to 99%)
- 3rd stage: oil balance technology between compressors
- 4th stage: oil balance technology between modules
- 5th stage: intelligent system oil return program

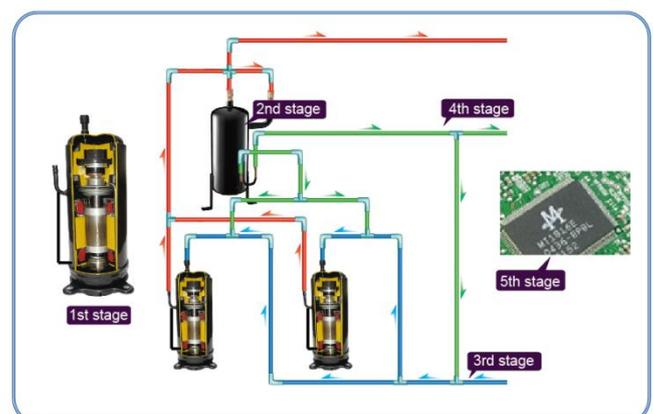

**1.4 Enhanced comfort**

**1.4.1 Night silent operation mode**

The Night Silent Mode feature which is easily set on the PCB board allows the unit to be set to vary time options during Non-Peak and Peak operation time optimizing the units noise output.

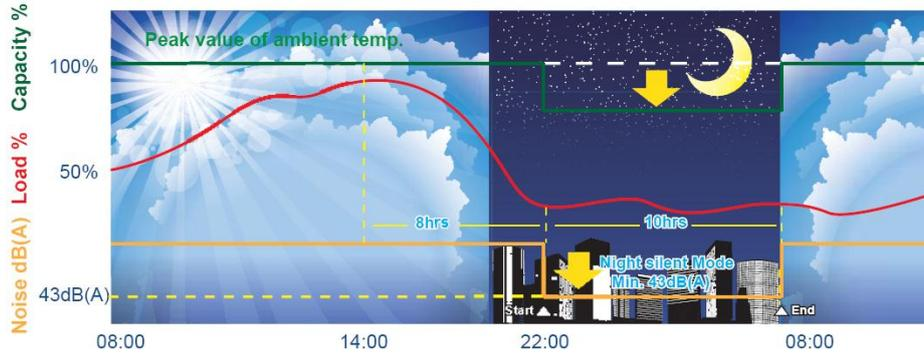

**1.4.2 Five priority mode lock function**

Heating priority mode; Cooling priority mode; Heating only priority mode; cooling only priority mode; VIP priority mode (address No. 63 is the VIP) or Voting priority mode.

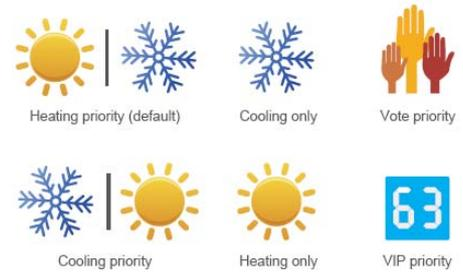

**1.4.3 Intelligent defrosting technology**

Intelligent defrosting program to judge the defrosting time according to the system real requirement, reduce the heating loss by unnecessary defrosting and make the indoor side more comfortable. Every time defrosting last only 4 minutes due to the use of specialized defrosting valve.

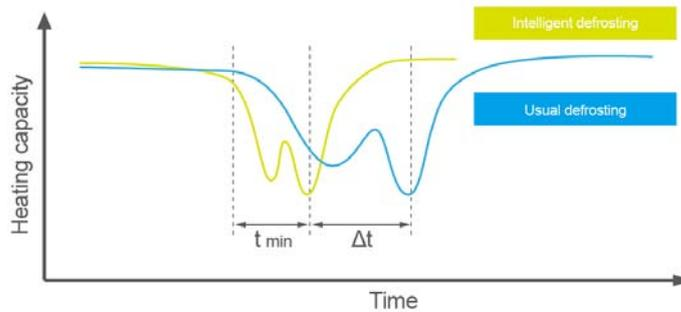

**1.4.4 Quick warm-up & cool-down design and less temperature fluctuation**

By utilizing the benefits of the DC inverter compressor, the system can reach full load quickly and shorten the warm-up and cool-down times to provide an immediate and comfortable air solution.

Less temperature fluctuation will create a better living environment.

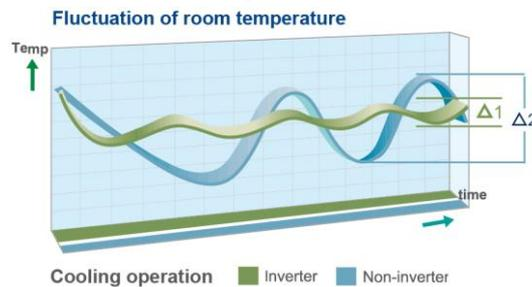

## 1.5 Convenient installation & maintenance

### 1.5.1 Auto addressing

Outdoor unit can distribute address for each indoor unit automatically.

Wireless and wired controllers can enquire and modify each indoor unit's address.



### 1.5.2 Simple communication wiring

Centralized controller (CCM30) can connect from indoor side or outdoor side (XYE terminals). With one group of wires, we can realize the network communication and system communication. Such simple wiring is more convenient for installation work at site.



### 1.5.3 Rotatable electric box

- The newly designed rotating control box is so excellent that it can rotate in a 150° angle. It is convenient for the inspection and maintenance of the pipeline system and greatly reduced the time of dismount the electric control box.
- Checking window for quick inspection of system status.
- Compressor is located at outside, which is simplified to checked and enable valves or compressor parts to be replaced easily.



## 2. Outdoor units

### ● Outdoor units lineup

The capacity range of outdoor units is from 8HP up to 88HP in 2HP increment. Maximum 64 indoor units with capacity up to 130% of total outdoor units can be connected as one refrigeration system.



8,10,12HP



14,16,18,20,22HP



24~44HP



46~66HP



68~88HP



### ● Combination table

HP	Standard combination		High efficiency recommend combination		Max. Qty. of indoor units num.	Max. recommended Qty. of indoor unit
	Model	Combination type	Model	Combination type		
8	MVD-V5X252W/V2GN1	8HP×1	MVD-V5X252W/V2GN1	8HP×1	13	7
10	MVD-V5X280W/V2GN1	10HP×1	MVD-V5X280W/V2GN1	10HP×1	16	9
12	MVD-V5X335W/V2GN1	12HP×1	MVD-V5X335W/V2GN1	12HP×1	20	11
14	MVD-V5X400W/V2GN1	14HP×1	MVD-V5X400W/V2GN1	14HP×1	23	13
16	MVD-V5X450W/V2GN1	16HP×1	MVD-V5X504W/V2GN1	8HP×2	26	15
18	MVD-V5X500W/V2GN1	18HP×1	MVD-V5X532W/V2GN1	8HP+10HP	29	16
20	MVD-V5X560W/V2GN1	20HP×1	MVD-V5X587W/V2GN1	8HP+12HP	33	18
22	MVD-V5X615W/V2GN1	22HP×1	MVD-V5X652W/V2GN1	8HP+14HP	36	20
24	MVD-V5X670W/V2GN1	12HP×2	MVD-V5X756W/V2GN1	8HP×3	39	22
26	MVD-V5X730W/V2GN1	10HP+16HP	MVD-V5X784W/V2GN1	8HP×2+10HP	43	24
28	MVD-V5X780W/V2GN1	10HP+18HP	MVD-V5X839W/V2GN1	8HP×2+12HP	46	26
30	MVD-V5X840W/V2GN1	10HP+20HP	MVD-V5X904W/V2GN1	8HP×2+14HP	50	27
32	MVD-V5X895W/V2GN1	10HP+22HP	MVD-V5X1008W/V2GN1	8HP×4	53	29
34	MVD-V5X950W/V2GN1	12HP+22HP	MVD-V5X1036W/V2GN1	8HP×3+10HP	56	31
36	MVD-V5X1000W/V2GN1	18HP×2	MVD-V5X1091W/V2GN1	8HP×3+12HP	59	32
38	MVD-V5X1065W/V2GN1	16HP+22HP	MVD-V5X1156W/V2GN1	8HP×3+14HP	63	35
40	MVD-V5X1115W/V2GN1	18HP+22HP	MVD-V5X1174W/V2GN1	8HP×2+12HP×2	64	36
42	MVD-V5X1175W/V2GN1	20HP+22HP	MVD-V5X1239W/V2GN1	8HP×2+12HP+14HP	64	38
44	MVD-V5X1230W/V2GN1	22HP×2	MVD-V5X1257W/V2GN1	8HP+12HP×3	64	38
46	MVD-V5X1285W/V2GN1	12HP×2+22HP	MVD-V5X1322W/V2GN1	8HP+12HP×2+14HP	64	38
48	MVD-V5X1345W/V2GN1	10HP+16HP+22HP	MVD-V5X1340W/V2GN1	12HP×4	64	38
50	MVD-V5X1395W/V2GN1	10HP+18HP+22HP	MVD-V5X1405W/V2GN1	12HP×3+14HP	64	38
52	MVD-V5X1455W/V2GN1	10HP+20HP+22HP	MVD-V5X1470W/V2GN1	12HP×2+14HP×2	64	38
54	MVD-V5X1510W/V2GN1	10HP+22HP×2	MVD-V5X1535W/V2GN1	12HP+14HP×3	64	38
56	MVD-V5X1565W/V2GN1	12HP+22HP×2	MVD-V5X1600W/V2GN1	14HP×4	64	40
58	MVD-V5X1615W/V2GN1	18HP×2+22HP	MVD-V5X1635W/V2GN1	12HP+14HP×2+18HP	64	40
60	MVD-V5X1680W/V2GN1	16HP+22HP×2	MVD-V5X1700W/V2GN1	14HP×3+18HP	64	40
62	MVD-V5X1730W/V2GN1	18HP+22HP×2	MVD-V5X1760W/V2GN1	14HP×3+20HP	64	40
64	MVD-V5X1790W/V2GN1	20HP+22HP×2	MVD-V5X1800W/V2GN1	14HP×2+18HP×2	64	40
66	MVD-V5X1845W/V2GN1	22HP×3	MVD-V5X1860W/V2GN1	14HP×2+18HP+20HP	64	40
68	MVD-V5X1900W/V2GN1	12HP×2+22HP×2	MVD-V5X1900W/V2GN1	14HP+18HP×3	64	44
70	MVD-V5X1960W/V2GN1	10HP+16HP+22HP×2	MVD-V5X1960W/V2GN1	14HP+18HP×2+20HP	64	44
72	MVD-V5X2010W/V2GN1	10HP+18HP+22HP×2	MVD-V5X2000W/V2GN1	18HP×4	64	44
74	MVD-V5X2070W/V2GN1	10HP+20HP+22HP×2	MVD-V5X2160W/V2GN1	18HP×4+20HP	64	44
76	MVD-V5X2125W/V2GN1	10HP+22HP×3	MVD-V5X2120W/V2GN1	18HP×2+20HP×2	64	44
78	MVD-V5X2180W/V2GN1	12HP+22HP×3	MVD-V5X2180W/V2GN1	18HP+20HP×3	64	48
80	MVD-V5X2230W/V2GN1	18HP×2+22HP×2	MVD-V5X2240W/V2GN1	20HP×4	64	48
82	MVD-V5X2295W/V2GN1	16HP+22HP×3	MVD-V5X2295W/V2GN1	20HP×3+22HP	64	48
84	MVD-V5X2345W/V2GN1	18HP+22HP×3	MVD-V5X2350W/V2GN1	20HP×2+22HP×2	64	48
86	MVD-V5X2405W/V2GN1	20HP+22HP×3	MVD-V5X2405W/V2GN1	20HP+22HP×3	64	48
88	MVD-V5X2460W/V2GN1	22HP×4	MVD-V5X2460W/V2GN1	22HP×4	64	48

**3. Indoor units lineup**

Capacity (kW)	Type					
	One-way cassette	Two-way Cassette	Compact four-way cassette	Four-way cassette	Low static pressure duct	Concealed duct unit (A5 Type)
1.8	1.8				1.8	
2.2	2.2	2.2	2.2		2.2	2.2
2.8	2.8	2.8	2.8	2.8	2.8	2.8
3.6	3.6	3.6	3.6	3.6	3.6	3.6
4.5	4.5	4.5	4.5	4.5	4.5	4.5
5.6	5.6	5.6		5.6	5.6	5.6
7.1		7.1		7.1	7.1	7.1
8				8		8
9				9		9
10				10		
11.2				11.2		11.2
12.5						
14				14		14

Capacity (kW)	High static pressure duct	Type				
		Ceiling & floor	Wall mounted	Console	Floor standing	Fresh air processing Unit
1.8						
2.2			2.2	2.2	2.2	
2.8			2.8	2.8	2.8	
3.6		3.6	3.6	3.6	3.6	
4.5		4.5	4.5	4.5	4.5	
5.6		5.6	5.6		5.6	
7.1	7.1	7.1	7.1		7.1	
8	8	8	8		8	
9	9	9	9			
10						
11.2	11.2	11.2				
12.5						12.5
14	14	14				14
16	16	16				
20	20					20
25	25					25
28	28					28
40	40					
45	45					
56	56					

Due to continuous improvement, specifications are subject to change without prior notice.

## 4. Nomenclature

### MVD-V5X252 W / V2 G N1

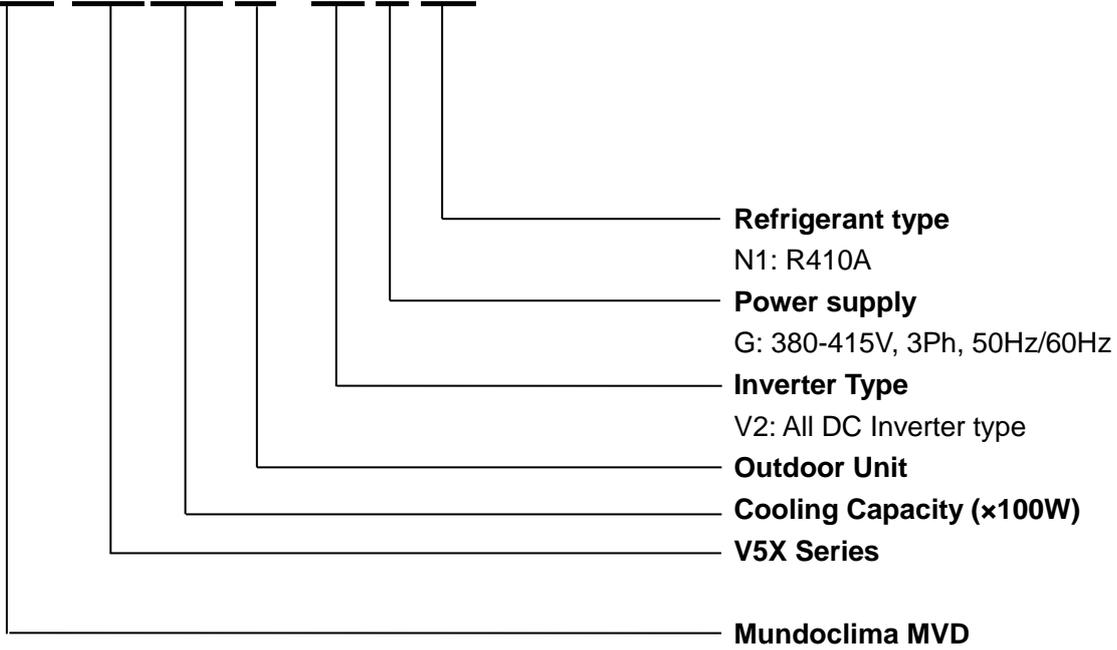

# Part 2 Selection Procedure

- 1. Product lineup ..... 11
- 2. Unit selection (based on cooling load)..... 15

## 1. Product lineup

### 1.1 Model selection procedure

Select the model and calculate the capacity for each refrigerant system according to the procedure shown below.

- Calculation of the indoor air-conditioning load, Calculate the maximum air-conditioning load for each room or zone.

Selection of an air conditioning system

- Select the ideal air conditioning system for air conditioning of each room or zone

Design of the control system

- Design a suitable control system for the selected air conditioning system

Preliminary selection of indoor and outdoor units

- Make preliminary selections that are within the allowable range for the system

Check of the tubing length and level difference

- Check that the length of refrigerant tubing and the elevation difference are within the allowable ranges

Calculation of the corrected outdoor unit capacity

- Capacity correction coefficient for model, outdoor temperature conditions, tubing length and elevation difference.

Calculation of the actual capacity for each indoor unit

- Calculate the corrected indoor/outdoor capacity ratio, based on the corrected outdoor unit capacity and the total corrected capacity of all indoor units in the same system.

Recheck of the actual capacity for each indoor unit

- If the capacity is inadequate, reexamine the unit combinations.

### 1.2 Indoor unit selection

Enter INDOOR UNIT CAPACITY TABLES at given indoor and outdoor temperature. Select the unit that the capacity is the nearest to and greater than given load.

Note:

Individual indoor unit capacity is subject to change by the combination. Actual capacity has to be calculated according to the combination by using outdoor unit capacity table.

#### Calculation of actual capacity of indoor unit

Because the capacity of a multi air-conditioner changes according to the temperature conditions, tubing length, elevation difference and other factors, select the correct model after taking into account the various correction values. When selecting the model, calculate the corrected capacities of the outdoor unit and each indoor unit. Use the corrected outdoor unit capacity and the total corrected capacity of all the indoor units to calculate the actual final capacity of each indoor unit.

#### Find the indoor unit capacity correction coefficient for the following items:

- Capacity correction for the indoor unit temperature conditions

From the graph of capacity characteristics, use the indoor temperature to find the capacity correction coefficient.

- Capacity distribution ratio based on the indoor unit tubing length and elevation difference.

First, in the same way as for the outdoor unit, use the tubing length and elevation difference for each indoor unit to find the correction coefficient from the graph of capacity change characteristics

**Capacity distribution ratio for each indoor unit=Correction coefficient for that indoor unit / Correction coefficient for the outdoor unit**

### 1.3 Outdoor unit selection

Allowable combinations are indicated in INDOOR UNIT COMBINATION TOTAL CAPACITY INDEX TABLE.

In general, outdoor unit can be selected as follows though the location of the unit, zoning and usage of the

rooms may be considered.

The indoor and outdoor unit combination is determined that the sum of indoor unit capacity index is nearest to and smaller than the capacity index at 100% combination ratio of each outdoor unit. Up to 13~36 indoor units can be connected to one outdoor unit. It is recommended to choose a larger outdoor unit if the installation space is large enough.

If the combination ratio is greater than 100%, the indoor unit selection shall be reviewed by using actual capacity of each indoor unit.

#### INDOOR UNIT COMBINATION TOTAL CAPACITY INDEX TABLE

Outdoor Unit HP(kBtu/h)	Indoor Unit Combination Ratio kW(kBtu/h)								
	130%	120%	110%	100%	90%	80%	70%	60%	50%
8(86)	32.8 (111.8)	30.2 (103.2)	27.7 (94.6)	25.2 (86)	22.7 (77.4)	20.1 (68.8)	17.6 (60.2)	15.1 (51.6)	12.6 (43)
10(95.5)	36.4 (124.15)	33.6 (114.6)	30.8 (105.1)	28.0 (95.5)	25.2 (86)	22.4 (76.4)	19.6 (66.9)	16.8 (57.3)	14.0 (47.75)
12(114.3)	43.6 (148.6)	40.2 (137.2)	36.9 (125.7)	33.5 (114.3)	30.2 (102.9)	26.8 (91.4)	23.5 (80)	20.2 (68.6)	16.8 (57.2)
14(136.5)	52.0 (177.5)	48.0 (163.8)	44.0 (150.2)	40.0 (136.5)	36.0 (122.9)	32.0 (109.2)	28.0 (95.6)	24.0 (81.9)	20.0 (68.3)
16(153.5)	58.5 (199.6)	54.0 (184.2)	49.5 (168.9)	45.0 (153.5)	40.5 (138.2)	36.0 (122.8)	31.5 (107.5)	27.0 (92.1)	22.5 (76.8)
18(170.6)	65.0 (221.8)	60.0 (204.7)	55.0 (187.7)	50.0 (170.6)	45.0 (153.5)	40.0 (136.5)	35.0 (119.4)	30.0 (102.4)	25.0 (85.3)
20(191.1)	72.8 (248.4)	67.2 (229.3)	61.6 (210.2)	56.0 (191.1)	50.4 (172)	44.8 (152.9)	39.2 (133.8)	33.6 (114.7)	28.0 (95.6)
22(209.8)	80.0 (272.7)	73.8 (251.8)	67.7 (230.8)	61.5 (209.8)	55.4 (188.8)	49.2 (167.8)	43.1 (146.9)	36.9 (125.9)	30.8 (104.9)
24(228.6)	87.1 (297.2)	80.4 (274.3)	73.7 (251.5)	67.0 (228.6)	60.3 (205.7)	53.6 (182.9)	46.9 (160)	40.2 (137.2)	33.5 (114.3)
26(249)	94.9 (323.7)	87.6 (298.8)	80.3 (273.9)	73.0 (249)	65.7 (224.1)	58.4 (199.2)	51.1 (174.3)	43.8 (149.4)	36.5 (124.5)
28(266.1)	101.4 (345.9)	93.6 (319.3)	85.8 (292.7)	78.0 (266.1)	70.2 (239.5)	62.4 (212.9)	54.6 (186.3)	46.8 (159.7)	39.0 (133.1)
30(286.6)	109.2 (372.6)	100.8 (343.9)	92.4 (315.3)	84.0 (286.6)	75.6 (257.9)	67.2 (229.3)	58.8 (200.6)	50.4 (172)	42.0 (143.3)
32(305.3)	116.4 (396.9)	107.4 (366.4)	98.5 (335.8)	89.5 (305.3)	80.6 (274.8)	71.6 (244.2)	62.7 (213.7)	53.7 (183.2)	44.8 (152.7)
34(324.1)	123.5 (421.3)	114.0 (388.9)	104.5 (356.5)	95.0 (324.1)	85.5 (291.7)	76.0 (259.3)	66.5 (226.9)	57.0 (194.5)	47.5 (162.1)
36(341.2)	130.0 (443.6)	120.0 (409.4)	110.0 (375.3)	100.0 (341.2)	90.0 (307.1)	80.0 (273)	70.0 (238.8)	60.0 (204.7)	50.0 (170.6)
38(363.3)	138.5 (472.3)	127.8 (436)	117.2 (399.6)	106.5 (363.3)	95.9 (327)	85.2 (290.6)	74.6 (254.3)	63.9 (218)	53.3 (181.7)
40(380.4)	145.0 (494.5)	133.8 (456.5)	122.7 (418.4)	111.5 (380.4)	100.4 (342.4)	89.2 (304.3)	78.1 (266.3)	66.9 (228.2)	55.8 (190.2)
42(400.9)	152.8 (521.2)	141.0 (481.1)	129.3 (441)	117.5 (400.9)	105.8 (360.8)	94.0 (320.7)	82.3 (280.6)	70.5 (240.5)	58.8 (200.5)
44(419.6)	159.9 (545.5)	147.6 (503.5)	135.3 (461.6)	123.0 (419.6)	110.7 (377.6)	98.4 (335.7)	86.1 (293.7)	73.8 (251.8)	61.5 (209.8)
46(438.4)	167.1 (569.9)	154.2 (526.1)	141.4 (482.2)	128.5 (438.4)	115.7 (394.6)	102.8 (350.7)	90.0 (306.9)	77.1 (263)	64.3 (219.2)
48(458.8)	174.9 (596.4)	161.4 (550.6)	148.0 (504.7)	134.5 (458.8)	121.1 (412.9)	107.6 (367)	94.2 (321.2)	80.7 (275.3)	67.3 (229.4)
50(475.9)	181.4 (618.7)	167.4 (571.1)	153.5 (523.5)	139.5 (475.9)	125.6 (428.3)	111.6 (380.7)	97.7 (333.1)	83.7 (285.5)	69.8 (238)
52(496.4)	189.2 (645.3)	174.6 (595.7)	160.1 (546)	145.5 (496.4)	131.0 (446.8)	116.4 (397.1)	101.9 (347.5)	87.3 (297.8)	72.8 (248.2)
54(515.1)	196.3 (669.6)	181.2 (618.1)	166.1 (566.6)	151.0 (515.1)	135.9 (463.6)	120.8 (412.1)	105.7 (360.6)	90.6 (309.1)	75.5 (257.6)
56(533.9)	203.5 (694.1)	187.8 (640.7)	172.2 (587.3)	156.5 (533.9)	140.9 (480.5)	125.2 (427.1)	109.6 (373.7)	93.9 (320.3)	78.3 (267)
58(551)	210.0 (716.3)	193.8 (661.2)	177.7 (606.1)	161.5 (551)	145.4 (495.9)	129.2 (440.8)	113.1 (385.7)	96.9 (330.6)	80.8 (275.5)
60(573.1)	218.4 (745)	201.6 (687.7)	184.8 (630.4)	168.0 (573.1)	151.2 (515.8)	134.4 (458.5)	117.6 (401.2)	100.8 (343.9)	84.0 (286.6)

**INDOOR UNIT COMBINATION TOTAL CAPACITY INDEX TABLE**

Outdoor Unit	Indoor Unit Combination Ratio kW(Btu/h)								
	130%	120%	110%	100%	90%	80%	70%	60%	50%
62(590.2)	224.9 (767.3)	207.6 (708.2)	190.3 (649.2)	173.0 (590.2)	155.7 (531.2)	138.4 (472.2)	121.1 (413.1)	103.8 (354.1)	86.5 (295.1)
64(610.7)	232.7 (793.9)	214.8 (732.8)	196.9 (671.8)	179.0 (610.7)	161.1 (549.6)	143.2 (488.6)	125.3 (427.5)	107.4 (366.4)	89.5 (305.4)
66(629.4)	239.9 (818.2)	221.4 (755.3)	203.0 (692.3)	184.5 (629.4)	166.1 (566.5)	147.6 (503.5)	129.2 (440.6)	110.7 (377.6)	92.3 (314.7)
68(648.2)	247.0 (842.7)	228.0 (777.8)	209.0 (713)	190.0 (648.2)	171.0 (583.4)	152.0 (518.6)	133.0 (453.7)	114.0 (388.9)	95.0 (324.1)
70(668.6)	254.8 (869.2)	235.2 (802.3)	215.6 (735.5)	196.0 (668.6)	176.4 (601.7)	156.8 (534.9)	137.2 (468)	117.6 (401.2)	98.0 (334.3)
72(685.7)	261.3 (891.4)	241.2 (822.8)	221.1 (754.3)	201.0 (685.7)	180.9 (617.1)	160.8 (548.6)	140.7 (480)	120.6 (411.4)	100.5 (342.9)
74(706.2)	269.1 (918.1)	248.4 (847.4)	227.7 (776.8)	207.0 (706.2)	186.3 (635.6)	165.6 (565)	144.9 (493.4)	124.2 (423.7)	103.5 (353.1)
76(724.9)	276.3 (942.4)	255.0 (869.9)	233.8 (797.4)	212.5 (724.9)	191.3 (652.4)	170.0 (579.9)	148.8 (507.4)	127.5 (434.9)	106.3 (362.5)
78(743.7)	283.4 (966.8)	261.6 (892.4)	239.8 (818.1)	218.0 (743.7)	196.2 (669.3)	174.4 (595)	152.6 (520.6)	130.8 (446.2)	109.0 (371.9)
80(760.8)	289.9 (989)	267.6 (913)	245.3 (836.9)	223.0 (760.8)	200.7 (684.7)	178.4 (608.6)	156.1 (532.6)	133.8 (456.5)	111.5 (380.4)
82(782.9)	298.4 (1017.8)	275.4 (939.5)	252.5 (861.2)	229.5 (782.9)	206.6 (704.6)	183.6 (626.3)	160.7 (548)	137.7 (469.7)	114.8 (391.5)
84(800)	304.9 (1040)	281.4 (960)	258.0 (880)	234.5 (800)	211.1 (720)	187.6 (640)	164.2 (560)	140.7 (480)	117.3 (400)
86(820.5)	312.7 (1066.7)	288.6 (984.6)	264.6 (902.6)	240.5 (820.5)	216.5 (738.5)	192.4 (656.4)	168.4 (574.4)	144.3 (492.3)	120.3 (410.3)
88(839.2)	319.8 (1091)	295.2 (1007)	270.6 (923.1)	246.0 (839.2)	221.4 (755.3)	196.8 (671.4)	172.2 (587.4)	147.6 (503.5)	123.0 (419.6)

**INDOOR UNIT CAPACITY INDEX**

Unit Size	Model 18	Model 22	Model 28	Model 36	Model 45	Model 56	Model 71	Model 80	Model 90	Model 112
Capacity Index kW(kBtu/h)	1.8 (6.14)	2.2 (7.5)	2.8 (9.55)	3.6 (12.28)	4.5 (15.35)	5.6 (19.11)	7.1 (24.23)	8.0 (27.3)	9.0 (30.71)	11.2 (38.22)
Unit Size	Model 125	Model 140	Model 160	Model 200	Model 250	Model 280	Model 400	Model 450	Model 560	
Capacity Index kW(Btu/h)	12.5 (42.65)	14.0 (47.77)	16 (54.59)	20 (68.24)	25 (85.3)	28 (95.54)	40 (136.5)	45 (153.5)	56 (191.07)	

**1.4 Actual performance data**

Use OUTDOOR UNIT CAPACITY TABLES.

Determine correct table according to the outdoor unit model and combination ratio.

Enter the table at given indoor and outdoor temperature and find the outdoor unit capacity and power input.

The individual indoor unit capacity (power input) can be calculated as follows.

$$IUC = OUC \times INX / TNX$$

Where,

**IUC:** Each indoor unit capacity

**OUC:** Outdoors unit capacity

**INX:** Each indoor unit capacity index

**TNX:** Total capacity index

Then, correct the indoor unit capacity according to the piping length.

If the corrected capacity is smaller than the load, the size of indoor unit has to be increased and repeat the same selection procedure.

### 1.5 Cooling capacity modification in accordance with the length of refrigerant pipe

Modification coefficient of the length and high difference of refrigerant pipe:

#### 1.5.1 Cooling capacity modification

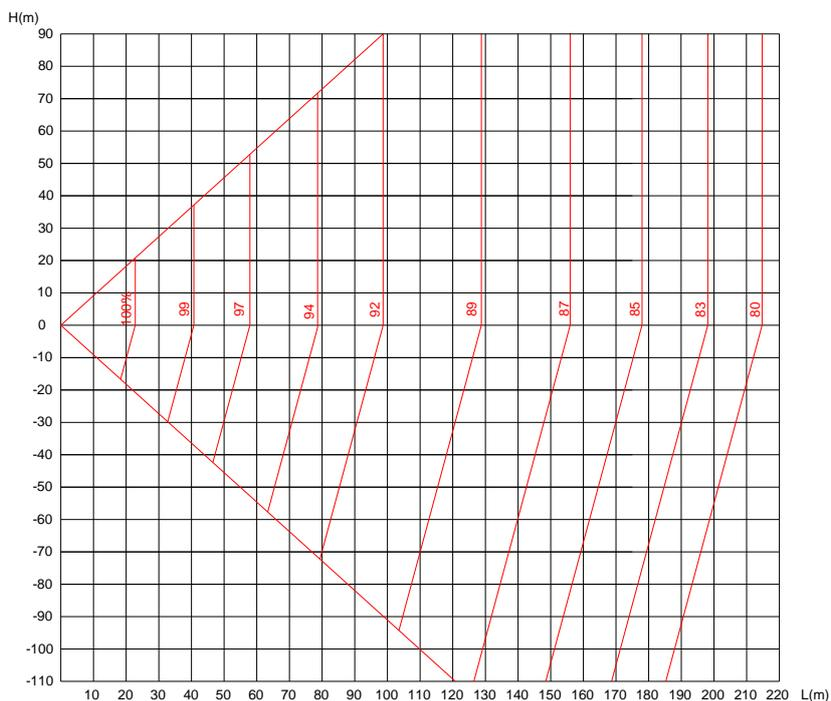

L: Refrigerant pipe equivalent length

H: Height difference between outdoor and indoor unit. Positive data means outdoor unit is top. Negative data means outdoor unit is down.

#### 1.5.2 Heating capacity modification

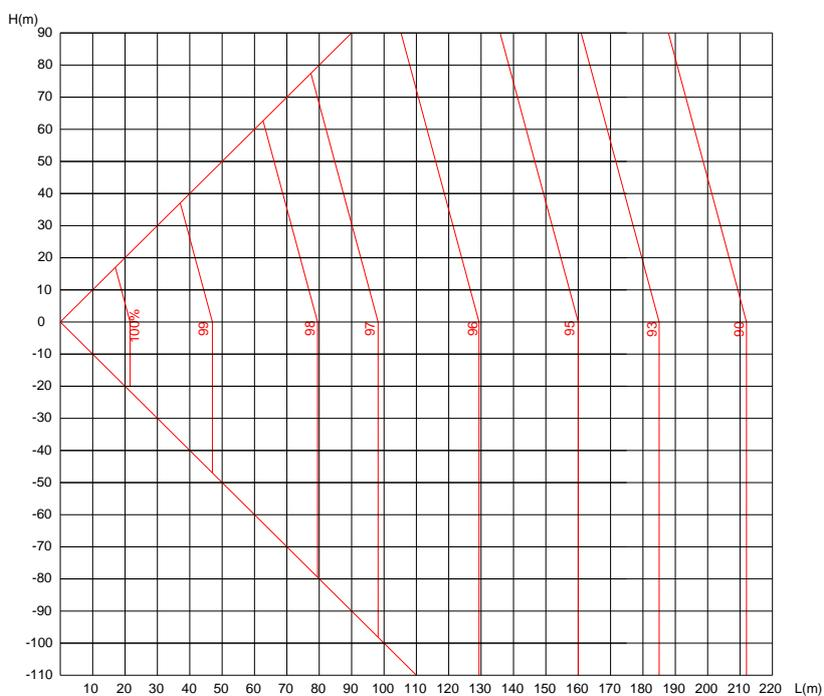



## 2. Unit selection (based on cooling load)

### 2.1 Given condition

Condition:

Cooling: indoor temperature 20°C (68°F)WB, outdoor temperature 35°C(95°F)DB;

Cooling load

Location	Room A	Room B	Room C	Room D	Room E	Room F
Load kW(Btu/h)	2.1(7170)	2.8(9559)	3.5(11900)	4.6(15700)	5.8(19790)	7.2(24570)

Power supply: outdoor 380~415V-3Ph-50Hz, indoor 220~240V-1Ph-50Hz.

Piping length: 164ft (50m); Height difference between indoor unit and outdoor unit: 98.4ft (30m)

### 2.2 Indoor unit selection

Select the suitable capacity for condition of 'Indoor 20°C(68°F) WB, Outdoor 35°C(95°F) DB' using indoor unit capacity table. The selected result is as follows. (Assuming the indoor unit type is duct)

Location	Room A	Room B	Room C	Room D	Room E	Room F
Load kW(Btu/h)	2.1(7170)	2.8(9559)	3.5(11900)	4.6(15700)	5.8(19790)	7.2(24570)
Model	22	28	36	45	56	71
Capacity kW(Btu/h)	2.3(7850)	2.9(9900)	3.7(12600)	4.8(16400)	6.0(20500)	7.5(25600)

### 2.3 Outdoor unit selection

1) Assume the indoor unit and outdoor unit combination as follows

- ♦ Calculate the total nominal capacity of indoor units in the combination according to the above table:

$$2.2 \times 1 + 2.8 \times 1 + 3.6 \times 1 + 4.5 \times 1 + 5.6 \times 1 + 7.1 \times 1 = 25.8\text{kW} (88000\text{Btu/h})$$

- ♦ Select outdoor unit: MV5-X280W/V2GN1 which has nominal cooling capacity: 28kW (95500Btu/h).
- ♦ Calculate the proportion:  $25.8/28 = 92\%$

2) Result: Because the proportion is within 50~130%, it is a right selection.

Real function data with indoor unit combination

- ♦ For the 92% combination, calculate the cooling capacity of outdoor unit MV5-X280W/V2GN1:

26.8kW(91440Btu/h) ← 90% (Indoor temperature: WB 20°C(68°F), Outdoor temperature: DB 35°C(95°F))

28.3kW(96560Btu/h) ← 100% (Indoor temperature: WB 20°C(68°F), Outdoor temperature: DB 35°C(95°F))

Then calculate the outdoor capacity in 92% combination index:  $26.8 + \{(28.3 - 26.8) / 10\} \times 2 = 27.1\text{kW} (92470\text{Btu/h})$ ;

- ♦ Capacity modification coefficient with pipe length 50m(164ft) and height difference 30m(98.4ft): 0.958
- ♦ Each indoor unit cooling capacity

**Room A:** MDV-D22T2 ( $27.1 \times 22 / 258 \times 0.958 = 2.21\text{kW}$ ) ( $92470 \times 7510 / 88000 \times 0.958 = 7540\text{Btu/h}$ )

**Room B:** MDV-D28T2 ( $27.1 \times 28 / 258 \times 0.958 = 2.82\text{kW}$ ) ( $92470 \times 9550 / 88000 \times 0.958 = 9620\text{Btu/h}$ )

**Room C:** MDV-D36T2 ( $27.1 \times 36 / 258 \times 0.958 = 3.62\text{kW}$ ) ( $92470 \times 12300 / 88000 \times 0.958 = 12350\text{Btu/h}$ )

**Room D:** MDV-D45T2 ( $27.1 \times 45 / 258 \times 0.958 = 4.53\text{kW}$ ) ( $92470 \times 15400 / 88000 \times 0.958 = 15460\text{Btu/h}$ )

**Room E:** MDV-D56T2 ( $27.1 \times 56 / 258 \times 0.958 = 5.64\text{kW}$ ) ( $92470 \times 19110 / 88000 \times 0.958 = 19250\text{Btu/h}$ )

**Room F:** MDV-D71T2 ( $27.1 \times 71 / 258 \times 0.958 = 7.14\text{kW}$ ) ( $92470 \times 24200 / 88000 \times 0.958 = 24360\text{Btu/h}$ )

Location	Room A	Room B	Room C	Room D	Room E	Room F
Load kW(Btu/h)	2.1(7170)	2.8(9559)	3.5(11900)	4.6(15700)	5.8(19790)	7.2(24570)
Model	22	28	36	45	56	71
Capacity kW(Btu/h)	2.21(7540)	2.82(9620)	3.62(12350)	4.53(15460)	5.64(19250)	7.14(24360)

### 2.4 Conclusion

Generally, we think this result is acceptable, so we can think we have accomplished the calculation. But if you think this result is not acceptable, you can repeat the above process.

Remark: In this sample, other capacity modification indexes don't be considered and are assumed as 1.0.

For more details about the effect factor such as outside ambient/inside ambient DB/WD, please refer to the performance table of indoor and outdoor units.

# Part 3 Specifications & Performances

- 1. Specifications ..... 17
- 2. Dimensions ..... 43
- 3. Service space ..... 45
- 4. Piping diagrams ..... 46
- 5. Wiring diagram and field wiring ..... 48
- 6. Electric characteristics ..... 51
- 7. Capacity tables ..... 52
- 8. Operation limits ..... 116
- 9. Sound levels ..... 117
- 10. Accessories ..... 118
- 11. Functional parts and safety devices ..... 119

## 1. Specifications

### Outdoor unit specifications

#### Independent unit specifications

HP		8	10	12	14	
Model		MVD-V5X252W/V2GN1	MVD-V5X280W/V2GN1	MVD-V5X335W/V2GN1	MVD-V5X400W/V2GN1	
Power source		V-Ph-Hz	380~415V 3N 50Hz/60Hz			
Cooling	Capacity	kW	25.2	28.0	33.5	40.0
		RT	7.2	8.0	9.5	11.4
		kBtu/h	86.0	95.5	114.3	136.5
		kcal/h	21,672	24,080	28,810	34,400
	Power input	kW	5.79	7.02	8.71	10.81
EER	kW/kW	4.35	3.99	3.85	3.70	
Heating	Capacity	kW	27.0	31.5	37.5	45.0
		RT	7.7	8.9	10.7	12.8
		kBtu/h	92.1	107.5	128.0	153.5
		kcal/h	23,220	27,090	32,250	38,700
	Power input	kW	5.79	7.19	8.82	10.98
COP	kW/kW	4.66	4.38	4.25	4.10	
Max. input consumption		W	11360	11360	12488	16180
Max. current		A	19.8	19.8	20.6	25.9
DC inverter compressor	Model		E655DHD-65D2YG	E655DHD-65D2YG	E705DHD-72D2YG	E405DHD-42D2YG
	Quantity		1	1	1	2
	Type		DC inverter	DC inverter	DC inverter	DC inverter
	Brand		Hitachi	Hitachi	Hitachi	Hitachi
	Capacity	kW	31.59	31.59	23.25	13.8x2
		kBtu/h	107.8	107.8	79.3	47.1x2
	Crankcase heater	W	27.6x2	27.6x2	27.6x2	27.6x4
	Refrigerant oil type		FVC68D	FVC68D	FVC68D	FVC68D
Refrigerant oil charge	gal. (ml)	0.132(500)	0.132(500)	0.132(500)	0.132(500)x2	
Outdoor fan motor	Model		WZDK560-38G(B)	WZDK560-38G(B)	WZDK560-38G(B)	WZDK560-38G(B)
	Type		DC motor	DC motor	DC motor	DC motor
	Brand		Panasonic/Nidec	Panasonic/Nidec	Panasonic/Nidec	Panasonic/Nidec
	Quantity		1	1	1	2
	Insulation class		E	E	E	E
	Safe class		IP23	IP23	IP23	IP23
	Input	W	580	580	580	360+290
	Output	W	465	465	465	290+230
Outdoor fan	Material		Plastic	Plastic	Plastic	Plastic
	Type		Axial	Axial	Axial	Axial
	Fan Quantity		1	1	1	2
	External static pressure	in. W.G. (Pa)	0~0.08(0~20) (default)			
in. W.G. (Pa)		0.08~0.24(20~60) (customized)				
Outdoor coil	Number of rows		2	2	3	2
	Tube pitch(a) x row pitch(b)	in.(mm)	7/8x3/4(22x19)	7/8x3/4(22x19)	7/8x3/4(22x19)	7/8x3/4(22x19)
	Fin spacing	in.(mm)	1/16(1.6)	1/16(1.6)	1/16(1.6)	1/16(1.6)

	Fin type		Hydrophilic aluminum			
	Tube outside diameter	in.(mm)	Φ5/16(Φ7.94)	Φ5/16(Φ7.94)	Φ5/16(Φ7.94)	Φ5/16(Φ7.94)
	Tube type		Inner-grooved	Inner-grooved	Inner-grooved	Inner-grooved
	Coil length x height	in.(mm)	77-9/16x48-1/2 (1970x1232)	77-9/16x48-1/2 (1970x1232)	77-9/16x48-1/2 (1970x1232)	91-3/8x48-1/2 (2320x1232)
	Number of circuits		22	22	22	22
Outdoor air flow		m <sup>3</sup> /h	12,000	12,000	12,000	14,000
		CFM	7,060	7,060	7,060	8,240
Sound pressure level		dB(A)	43~58	43~59	43~60	43~62
Connectable indoor unit	Total capacity	%	50-130	50-130	50-130	50-130
	Max. quantity		13	16	20	23
Outdoor unit	Dimension (WxHxD)	inch	39x64-3/8x31-1/8			52-3/4x64-3/8x31-1/8
		mm	990x1635x790			1340x1635x790
	Packing (WxHxD)	inch	41-1/2x71-1/16x33-5/8			55-3/8x71-1/16x33-5/8
		mm	1055x1805x855			1405x1805x855
	Net weight	lbs.(kg)	483(219)	483(219)	523(237)	655(297)
	Gross weight	lbs.(kg)	516(234)	516(234)	556(252)	695(315)
Refrigerant	Type		R410A	R410A	R410A	R410A
	Factory charged	lbs.(kg)	20(9)	20(9)	24(11)	29(13)
Throttle type			EXV	EXV	EXV	EXV
Design pressure(High/low)		MPa	4.4/2.6	4.4/2.6	4.4/2.6	4.4/2.6
		psi	640/380	640/380	640/380	640/380
Pipe connections	Liquid pipe	in.(mm)	Φ3/8(Φ9.53)	Φ3/8(Φ9.53)	Φ1/2(Φ12.7)	Φ1/2(Φ12.7)
	Gas pipe	in.(mm)	Φ7/8(Φ22.2)	Φ7/8(Φ22.2)	Φ1(Φ25.4)	Φ1(Φ25.4)
	Oil balance pipe	in.(mm)	Φ5/16(Φ8)	Φ5/16(Φ8)	Φ5/16(Φ8)	Φ5/16(Φ8)
Operating temperature range	Cooling	°F(°C)	23~118.4(-5~48)			
	Heating	°F(°C)	-4~75.2(-20~24)			

## Notes:

Capacities are based on the following conditions:

Cooling: Indoor temperature 27°C(80.6°F) DB/19°C(66.2°F) WB; Outdoor temperature 35°C(95°F) DB/24°C(75.2°F) WB.

Heating: Indoor temperature 20°C(68°F) DB/15°C(59°F) WB; Outdoor temperature 7°C(44.6°F) DB/6°C(42.8°F) WB.

Piping length: Interconnecting piping length is 7.5m (24.6ft), level difference is zero.

Connection piping diameter is based on the condition that the total equivalent liquid length is less than 90m (295.2ft). When the total equivalent liquid length is more than 90m (295.2ft), please refer to technical manual to choose the connection piping diameter.

Sound values are measured in a semi-anechoic room, at a position 1m (3.28ft) in front of the unit and 1.3m (4.26ft) above the floor.

## Independent unit specifications

HP		16	18	20	22	
Model		MVD-V5X450W/V2GN1	MVD-V5X500W/V2GN1	MVD-V5X560W/V2GN1	MVD-V5X615W/V2GN1	
Power source		V-Ph-Hz	380~415V 3N 50Hz/60Hz			
Cooling	Capacity	kW	45.0	50.0	56.0	61.5
		RT	12.8	14.3	16.0	17.6
		kBtu/h	153.5	170.6	191.1	209.8
		kcal/h	38,700	43,000	48,160	52,890
	Power input	kW	12.83	14.47	16.67	18.77
EER	kW/kW	3.51	3.46	3.36	3.28	
Heating	Capacity	kW	50.0	56.0	63.0	69.0
		RT	14.2	16.0	18.0	19.7
		kBtu/h	170.6	191.1	214.9	235.4
		kcal/h	43,000	48,160	54,180	59,340
	Power input	kW	12.47	14.15	15.98	17.86
COP	kW/kW	4.01	3.96	3.94	3.86	
Max. input consumption		W	16180	18330	24116	24116
Max. current		A	25.9	29.0	42	42
DC inverter compressor	Model		E405DHD-42D2YG	E405DHD-36D2YG E705DHD-72D2YG	E705DHD-72D2YG	E705DHD-72D2YG
	Quantity		2	1+1	2	2
	Type		DC inverter	DC inverter	DC inverter	DC inverter
	Brand		Hitachi	Hitachi	Hitachi	Hitachi
	Capacity	kW	13.8×2	11.8+23.25	23.25×2	23.25×2
		kBtu/h	47.1×2	40.3+79.3	79.3×2	79.3×2
	Crankcase heater	W	27.6×4	27.6×4	27.6×4	27.6×4
	Refrigerant oil type		FVC68D	FVC68D	FVC68D	FVC68D
Refrigerant oil charge	gal. (ml)	0.132(500)×2	0.132(500)×2	0.132(500)×2	0.132(500)×2	
Outdoor fan motor	Model		WZDK560-38G(B)	WZDK560-38G(B)	WZDK560-38G(B)	WZDK560-38G(B)
	Type		DC motor	DC motor	DC motor	DC motor
	Brand		Panasonic/Nidec	Panasonic/Nidec	Panasonic/Nidec	Panasonic/Nidec
	Quantity		2	2	2	2
	Insulation class		E	E	E	E
	Safe class		IP23	IP23	IP23	IP23
	Input	W	360+290	520+440	550+430	550+430
	Output	W	290+230	420+350	440+350	440+350
Outdoor fan	Material		Plastic	Plastic	Plastic	Plastic
	Type		Axial	Axial	Axial	Axial
	Fan Quantity		2	2	2	2
	External static pressure	in. W.G. (Pa)	0~0.08(0~20) (default)			
in. W.G. (Pa)		0.08~0.24(20~60) (customized)				
Outdoor coil	Number of rows		2	2	3	3
	Tube pitch(a) ×row pitch(b)	in.(mm)	7/8×3/4(22×19)	7/8×3/4(22×19)	7/8×3/4(22×19)	7/8×3/4(22×19)
	Fin spacing	in.(mm)	1/16(1.6)	1/16(1.6)	1/16(1.6)	1/16(1.6)
	Fin type		Hydrophilic aluminum			

	Tube outside diameter	in.(mm)	Φ5/16(Φ7.94)	Φ5/16(Φ7.94)	Φ5/16(Φ7.94)	Φ5/16(Φ7.94)
	Tube type		Inner-grooved	Inner-grooved	Inner-grooved	Inner-grooved
	Coil length x height	in.(mm)	91-3/8x48-1/2 (2320x1232)	89-3/8x48-1/2 (2270x1232)	89-3/8x48-1/2 (2270x1232)	89-3/8x48-1/2 (2270x1232)
	Number of circuits		22	22	22	22
Outdoor air flow		m <sup>3</sup> /h	14,000	16,000	16,000	16,000
		CFM	8,240	9,410	9,410	9,410
Sound pressure level		dB(A)	43~62	43~63	43~63	43~63
Connectable indoor unit	Total capacity	%	50-130	50-130	50-130	50-130
	Max. quantity		26	29	33	36
Outdoor unit	Dimension (WxHxD)	inch	52-3/4x64-3/8x31-1/8			
		mm	1340x1635x790			
	Packing (WxHxD)	inch	55-3/8x71-1/16x33-5/8			
		mm	1405x1805x855			
	Net weight	lbs.(kg)	655(297)	673(305)	750(340)	750(340)
	Gross weight	lbs.(kg)	695(315)	712(323)	790(358)	790(358)
Refrigerant	Type		R410A	R410A	R410A	R410A
	Factory charged	lbs.(kg)	29(13)	29(13)	35(16)	35(16)
Throttle type			EXV	EXV	EXV	EXV
Design pressure(High/low)		MPa	4.4/2.6	4.4/2.6	4.4/2.6	4.4/2.6
		psi	640/380	640/380	640/380	640/380
Pipe connections	Liquid pipe	in.(mm)	Φ1/2(Φ12.7)	Φ5/8(Φ15.9)	Φ5/8(Φ15.9)	Φ5/8(Φ15.9)
	Gas pipe	in.(mm)	Φ1-1/8(Φ28.6)	Φ1-1/8(Φ28.6)	Φ1-1/8(Φ28.6)	Φ1-1/8(Φ28.6)
	Oil balance pipe	in.(mm)	Φ5/16(Φ8)	Φ5/16(Φ8)	Φ5/16(Φ8)	Φ5/16(Φ8)
Operating temperature range	Cooling	°F(°C)	23~118.4(-5~48)			
	Heating	°F(°C)	-4~75.2(-20~24)			

## Notes:

Capacities are based on the following conditions:

Cooling: Indoor temperature 27°C(80.6°F) DB/19°C(66.2°F) WB; Outdoor temperature 35°C(95°F) DB/24°C(75.2°F) WB.

Heating: Indoor temperature 20°C(68°F) DB/15°C(59°F) WB; Outdoor temperature 7°C(44.6°F) DB/6°C(42.8°F) WB.

Piping length: Interconnecting piping length is 7.5m (24.6ft), level difference is zero.

Connection piping diameter is based on the condition that the total equivalent liquid length is less than 90m (295.2ft). When the total equivalent liquid length is more than 90m (295.2ft), please refer to technical manual to choose the connection piping diameter.

Sound values are measured in a semi-anechoic room, at a position 1m (3.28ft) in front of the unit and 1.3m (4.26ft) above the floor.

## Combination unit specifications

HP		24	26	28	
Model	Combination Unit		MVD-V5X670W/V2GN1	MVD-V5X730W/V2GN1	MVD-V5X780W/V2GN1
	Independent Unit		MVD-V5X335W/V2GN1	MVD-V5X280W/V2GN1	MVD-V5X280W/V2GN1
			MVD-V5X335W/V2GN1	MVD-V5X450W/V2GN1	MVD-V5X500W/V2GN1
Power source		V-Ph-Hz	380~415V 3N 50Hz/60Hz		
Cooling	Capacity	kW	67.0	73.0	78.0
		RT	19.0	20.8	22.3
		kBtu/h	228.6	249.0	266.1
		kcal/h	57,620	62,780	67,080
	Power input	kW	17.42	19.85	21.49
EER	kW/kW	3.85	3.68	3.63	
Heating	Capacity	kW	75.0	81.5	87.5
		RT	21.4	23.1	24.9
		kBtu/h	256.0	278.1	298.6
		kcal/h	64,500	70,090	75,250
	Power input	kW	17.64	19.66	21.34
COP	kW/kW	4.25	4.15	4.10	
Max. input consumption		W	24976	27540	29690
Max. current		A	41.2	45.7	48.8
DC inverter compressor	Model		E705DHD-72D2YG×2	E655DHD-65D2YG+ E405DHD-42D2YG×2	E655DHD-65D2YG+ E405DHD-36D2YG+ E705DHD-72D2YG
	Quantity		2.0	3.0	3.0
	Type		DC inverter	DC inverter	DC inverter
	Brand		Hitachi	Hitachi	Hitachi
	Capacity	kW	46.5	21.06+(13.8×2)	21.06+(11.8+23.25)
		kBtu/h	158.6	71.9+(47.1×2)	71.9+(40.3+79.3)
	Crankcase heater	W	27.6×4	27.6×6	27.6×6
	Refrigerant oil type		FVC68D	FVC68D	FVC68D
Refrigerant oil charge	gal. (ml)	0.132×2(500×2)	0.132×3(500×3)	0.132×3(500×3)	
Outdoor fan motor	Model		WZDK560-38G(B)	WZDK560-38G(B)	WZDK560-38G(B)
	Type		DC motor	DC motor	DC motor
	Brand		Panasonic/Nidec	Panasonic/Nidec	Panasonic/Nidec
	Quantity		2.0	3.0	3.0
	Insulation class		E	E	E
	Safe class		IP23	IP23	IP23
	Input	W	580+580	580+(360+290)	580+(520+440)
	Output	W	465×2	465+(290+230)	465+(420+350)
Outdoor fan	Material		Plastic	Plastic	Plastic
	Type		Axial	Axial	Axial
	Fan Quantity		2	3	3
	External static pressure	in. W.G. (Pa)	0~0.08(0~20) (default)		
in. W.G. (Pa)		0.08~0.24(20~60) (customized)			
Outdoor coil	Tube pitch(a) xrow pitch(b)	in.(mm)	7/8×3/4(22×19)	7/8×3/4(22×19)	7/8×3/4(22×19)
	Fin spacing	in.(mm)	1/16(1.6)	1/16(1.6)	1/16(1.6)

		Fin type		Hydrophilic aluminum		
		Tube outside diameter	in.(mm)	Φ5/16(Φ7.94)	Φ5/16(Φ7.94)	Φ5/16(Φ7.94)
		Tube type		Inner-grooved	Inner-grooved	Inner-grooved
Outdoor air flow		m <sup>3</sup> /h	24,000	26,000	28,000	
		CFM	14,120	15,300	16,470	
Sound pressure level		dB(A)	64	65	65	
Connectable indoor unit	Total capacity	%	50-130	50-130	50-130	
	Max. quantity		39	43	46	
Outdoor unit	Dimension (W×H×D)	inch	(39×64-3/8×31-1/8)×2	39×64-3/8×31-1/8 +52-3/4×64-3/8×31-1/8	39×64-3/8×31-1/8 +52-3/4×64-3/8×31-1/8	
		mm	(990×1635×790)×2	990×1635×790 +1340×1635×790	990×1635×790 +1340×1635×790	
	Packing (W×H×D)	inch	(41-1/2×71-1/16×33-5/8)×2	41-1/2×71-1/16×33-5/8 +55-3/8×71-1/16×33-5/8	41-1/2×71-1/16×33-5/8 +55-3/8×71-1/16×33-5/8	
		mm	(1055×1805×855)×2	1055×1805×855 +1405×1805×855	1055×1805×855 +1405×1805×855	
	Net weight	lbs.(kg)	523(237)×2	483+655(219+297)	483+673(219+305)	
	Gross weight	lbs.(kg)	556(252)×2	516+695(234+315)	516+712(234+323)	
Refrigerant	Type		R410A	R410A	R410A	
	Factory charged	lbs.(kg)	24×2(11×2)	20+29(9+13)	20+29(9+13)	
Throttle type			EXV	EXV	EXV	
Design pressure(High/low)		MPa	4.4/2.6	4.4/2.6	4.4/2.6	
		psi	640/380	640/380	640/380	
Pipe connections	Liquid pipe	in.(mm)	Φ5/8(Φ15.9)	Φ3/4(Φ19.1)	Φ3/4(Φ19.1)	
	Gas pipe	in.(mm)	Φ1-1/8(Φ28.6)	Φ1-1/4(Φ31.8)	Φ1-1/4(Φ31.8)	
	Oil balance pipe	in.(mm)	Φ5/16(Φ8)	Φ5/16(Φ8)	Φ5/16(Φ8)	
Operating temperature range	Cooling	°F(°C)	23~118.4(-5~48)			
	Heating	°F(°C)	-4~75.2(-20~24)			

## Notes:

Capacities are based on the following conditions:

Cooling: Indoor temperature 27°C(80.6°F) DB/19°C(66.2°F) WB; Outdoor temperature 35°C(95°F) DB/24°C(75.2°F) WB.

Heating: Indoor temperature 20°C(68°F) DB/15°C(59°F) WB; Outdoor temperature 7°C(44.6°F) DB/6°C(42.8°F) WB.

Piping length: Interconnecting piping length is 7.5m (24.6ft), level difference is zero.

Connection piping diameter is based on the condition that the total equivalent liquid length is less than 90m (295.2ft). When the total equivalent liquid length is more than 90m (295.2ft), please refer to technical manual to choose the connection piping diameter.

Sound values are measured in a semi-anechoic room, at a position 1m (3.28ft) in front of the unit and 1.3m (4.26ft) above the floor.



## Combination unit specifications

HP			30	32	34
Model	Combination Unit		MVD-V5X840W/V2GN1	MVD-V5X895W/V2GN1	MVD-V5X950W/V2GN1
	Independent Unit		MVD-V5X280W/V2GN1	MVD-V5X280W/V2GN1	MVD-V5X335W/V2GN1
			MVD-V5X560W/V2GN1	MVD-V5X615W/V2GN1	MVD-V5X615W/V2GN1
Power source		V-Ph-Hz	380~415V 3N 50Hz/60Hz		
Cooling	Capacity	kW	84.0	89.5	95.0
		RT	24.0	25.6	27.1
		kBtu/h	286.6	305.3	324.1
		kcal/h	72,240	76,970	81,700
	Power input	kW	23.69	25.79	27.48
	EER	kW/kW	3.55	3.47	3.46
Heating	Capacity	kW	94.5	100.5	106.5
		RT	26.9	28.6	30.4
		kBtu/h	322.4	342.9	363.4
		kcal/h	81,270	86,430	91,590
	Power input	kW	23.17	25.05	26.68
	COP	kW/kW	4.08	4.01	3.99
Max. input consumption		W	35476	35476	36604
Max. current		A	61.8	61.8	62.6
DC inverter compressor	Model		E655DHD-65D2YG+ E705DHD-72D2YG×2	E655DHD-65D2YG+ E705DHD-72D2YG×2	E705DHD-72D2YG×3
	Quantity		3.0	3.0	3.0
	Type		DC inverter	DC inverter	DC inverter
	Brand		Hitachi	Hitachi	Hitachi
	Capacity	kW	21.06+(23.25×2)	21.06+(23.25×2)	23.25+(23.25×2)
		kBtu/h	71.9+(79.3×2)	71.9+(79.3×2)	79.3+(79.3×2)
	Crankcase heater	W	27.6×6	27.6×6	27.6×6
	Refrigerant oil type		FVC68D	FVC68D	FVC68D
	Refrigerant oil charge	gal. (ml)	0.132×3(500×3)	0.132×3(500×3)	0.132×3(500×3)
Outdoor fan motor	Model		WZDK560-38G(B)	WZDK560-38G(B)	WZDK560-38G(B)
	Type		DC motor	DC motor	DC motor
	Brand		Panasonic/Nidec	Panasonic/Nidec	Panasonic/Nidec
	Quantity		3.0	3.0	3.0
	Insulation class		E	E	E
	Safe class		IP23	IP23	IP23
	Input	W	580+(550+430)	580+(550+430)	580+(550+430)
	Output	W	465+(440+350)	465+(440+350)	465+(440+350)
Outdoor fan	Material		Plastic	Plastic	Plastic
	Type		Axial	Axial	Axial
	Fan Quantity		3	3	3
	External static pressure	in. W.G. (Pa)	0~0.08(0~20) (default)		
		in. W.G. (Pa)	0.08~0.24(20~60) (customized)		
Outdoor coil	Tube pitch(a) x row pitch(b)	in.(mm)	7/8x3/4(22x19)	7/8x3/4(22x19)	7/8x3/4(22x19)
	Fin spacing	in.(mm)	1/16(1.6)	1/16(1.6)	1/16(1.6)
	Fin type		Hydrophilic aluminum		

	Tube outside diameter	in.(mm)	Φ5/16(Φ7.94)	Φ5/16(Φ7.94)	Φ5/16(Φ7.94)
	Tube type		Inner-grooved	Inner-grooved	Inner-grooved
Outdoor air flow		m <sup>3</sup> /h	28,000	28,000	28,000
		CFM	16,470	16,470	16,470
Sound pressure level		dB(A)	65	65	65
Connectable indoor unit	Total capacity	%	50-130	50-130	50-130
	Max. quantity		50	53	56
Outdoor unit	Dimension(W×H×D)	inch	39×64-3/8×31-1/8 +52-3/4×64-3/8×31-1/8	39×64-3/8×31-1/8 +52-3/4×64-3/8×31-1/8	39×64-3/8×31-1/8 +52-3/4×64-3/8×31-1/8
		mm	990×1635×790 +1340×1635×790	990×1635×790 +1340×1635×790	990×1635×790 +1340×1635×790
	Packing(W×H×D)	inch	41-1/2×71-1/16×33-5/8 +55-3/8×71-1/16×33-5/8	41-1/2×71-1/16×33-5/8 +55-3/8×71-1/16×33-5/8	41-1/2×71-1/16×33-5/8 +55-3/8×71-1/16×33-5/8
		mm	1055×1805×855 +1405×1805×855	1055×1805×855 +1405×1805×855	1055×1805×855 +1405×1805×855
	Net weight	lbs.(kg)	483+750(219+340)	483+750(219+340)	523+750(237+340)
	Gross weight	lbs.(kg)	516+790(234+358)	516+790(234+358)	556+790(252+358)
Refrigerant	Type		R410A	R410A	R410A
	Factory charged	lbs.(kg)	20+35(9+16)	20+35(9+16)	24+35(11+16)
Throttle type			EXV	EXV	EXV
Design pressure(High/low)		MPa	4.4/2.6	4.4/2.6	4.4/2.6
		psi	640/380	640/380	640/380
Pipe connections	Liquid pipe	in.(mm)	Φ3/4(Φ19.1)	Φ3/4(Φ19.1)	Φ3/4(Φ19.1)
	Gas pipe	in.(mm)	Φ1-1/4(Φ31.8)	Φ1-1/4(Φ31.8)	Φ1-1/4(Φ31.8)
	Oil balance pipe	in.(mm)	Φ5/16(Φ8)	Φ5/16(Φ8)	Φ5/16(Φ8)
Operating temperature range	Cooling	°F(°C)	23~118.4(-5~48)		
	Heating	°F(°C)	-4~75.2(-20~24)		

## Notes:

Capacities are based on the following conditions:

Cooling: Indoor temperature 27°C(80.6°F) DB/19°C(66.2°F) WB; Outdoor temperature 35°C(95°F) DB/24°C(75.2°F) WB.

Heating: Indoor temperature 20°C(68°F) DB/15°C(59°F) WB; Outdoor temperature 7°C(44.6°F) DB/6°C(42.8°F) WB.

Piping length: Interconnecting piping length is 7.5m (24.6ft), level difference is zero.

Connection piping diameter is based on the condition that the total equivalent liquid length is less than 90m (295.2ft). When the total equivalent liquid length is more than 90m (295.2ft), please refer to technical manual to choose the connection piping diameter.

Sound values are measured in a semi-anechoic room, at a position 1m (3.28ft) in front of the unit and 1.3m (4.26ft) above the floor.

## Combination unit specifications

HP			36	38	40
Model	Combination Unit		MVD-V5X1000W/V2GN1	MVD-V5X1065W/V2GN1	MVD-V5X1115W/V2GN1
	Independent Unit		MVD-V5X500W/V2GN1	MVD-V5X450W/V2GN1	MVD-V5X500W/V2GN1
			MVD-V5X500W/V2GN1	MVD-V5X615W/V2GN1	MVD-V5X615W/V2GN1
Power source		V-Ph-Hz	380~415V 3N 50Hz/60Hz		
Cooling	Capacity	kW	100.0	106.5	111.5
		RT	28.6	30.4	31.9
		kBtu/h	341.2	363.3	380.4
		kcal/h	86,000	91,590	95,890
	Power input	kW	28.94	31.6	33.24
EER	kW/kW	3.46	3.37	3.35	
Heating	Capacity	kW	112.0	119.0	125.0
		RT	32.0	33.9	35.7
		kBtu/h	382.2	406.0	426.5
		kcal/h	96,320	102,340	107,500
	Power input	kW	28.3	30.33	32.01
COP	kW/kW	3.96	3.92	3.91	
Max. input consumption		W	36660	40296	42446
Max. current		A	58	67.9	71
DC inverter compressor	Model		E405DHD-36D2YG×2+ E705DHD-72D2YG×2	E405DHD-42D2YG×2+ E705DHD-72D2YG×2	E405DHD-36D2YG+ E705DHD-72D2YG×3
	Quantity		4.0	4.0	4.0
	Type		DC inverter	DC inverter	DC inverter
	Brand		Hitachi	Hitachi	Hitachi
	Capacity	kW	(11.8+23.25)×2	(13.8×2)+(23.25×2)	(11.8+23.25)+(23.25×2)
		kBtu/h	(40.3+79.3)×2	(47.1×2)+(79.3×2)	(40.3+79.3)+(79.3×2)
	Crankcase heater	W	27.6×8	27.6×8	27.6×8
	Refrigerant oil type		FVC68D	FVC68D	FVC68D
Refrigerant oil charge	gal. (ml)	0.132×4(500×4)	0.132×4(500×4)	0.132×4(500×4)	
Outdoor fan motor	Model		WZDK560-38G(B)	WZDK560-38G(B)	WZDK560-38G(B)
	Type		DC motor	DC motor	DC motor
	Brand		Panasonic/Nidec	Panasonic/Nidec	Panasonic/Nidec
	Quantity		4.0	4.0	4.0
	Insulation class		E	E	E
	Safe class		IP23	IP23	IP23
	Input	W	(520+440)×2	(360+290)+(550+430)	(520+440)+(550+430)
	Output	W	(420+350)×2	(290+230)+(440+350)	(420+350)+(440+350)
Outdoor fan	Material		Plastic	Plastic	Plastic
	Type		Axial	Axial	Axial
	Fan Quantity		4	4	4
	External static pressure	in. W.G. (Pa)	0~0.08(0~20) (default)		
in. W.G. (Pa)		0.08~0.24(20~60) (customized)			
Outdoor coil	Tube pitch(a) x row pitch(b)	in.(mm)	7/8x3/4(22x19)	7/8x3/4(22x19)	7/8x3/4(22x19)
	Fin spacing	in.(mm)	1/16(1.6)	1/16(1.6)	1/16(1.6)
	Fin type		Hydrophilic aluminum		

	Tube outside diameter	in.(mm)	Φ5/16(Φ7.94)	Φ5/16(Φ7.94)	Φ5/16(Φ7.94)
	Tube type		Inner-grooved	Inner-grooved	Inner-grooved
Outdoor air flow		m <sup>3</sup> /h	32,000	30,000	32,000
		CFM	18,820	17,650	18,820
Sound pressure level		dB(A)	66	66	66
Connectable indoor unit	Total capacity	%	50-130	50-130	50-130
	Max. quantity		59	63	64
Outdoor unit	Dimension(WxHxD)	inch	(52-3/4x64-3/8x31-1/8)x2	52-3/4x64-3/8x31-1/8 +52-3/4x64-3/8x31-1/8	52-3/4x64-3/8x31-1/8 +52-3/4x64-3/8x31-1/8
		mm	(1340x1635x790)x2	1340x1635x790 +1340x1635x790	1340x1635x790 +1340x1635x790
	Packing(WxHxD)	inch	(55-3/8x71-1/16x33-5/8)x2	55-3/8x71-1/16x33-5/8 +55-3/8x71-1/16x33-5/8	55-3/8x71-1/16x33-5/8 +55-3/8x71-1/16x33-5/8
		mm	(1405x1805x855)x2	1405x1805x855 +1405x1805x855	1405x1805x855 +1405x1805x855
	Net weight	lbs.(kg)	673x2(305x2)	655+750(297+340)	673+750(305+340)
	Gross weight	lbs.(kg)	712x2(323x2)	695+790(315+358)	712+790(323+358)
Refrigerant	Type		R410A	R410A	R410A
	Factory charged	lbs.(kg)	29x2(13x2)	29+35(13+16)	29+35(13+16)
Throttle type			EXV	EXV	EXV
Design pressure(High/low)		MPa	4.4/2.6	4.4/2.6	4.4/2.6
		psi	640/380	640/380	640/380
Pipe connections	Liquid pipe	in.(mm)	Φ3/4(Φ19.1)	Φ3/4(Φ19.1)	Φ3/4(Φ19.1)
	Gas pipe	in.(mm)	Φ1-1/2(Φ38.1)	Φ1-1/2(Φ38.1)	Φ1-1/2(Φ38.1)
	Oil balance pipe	in.(mm)	Φ5/16(Φ8)	Φ5/16(Φ8)	Φ5/16(Φ8)
Operating temperature range	Cooling	°F(°C)	23~118.4(-5~48)		
	Heating	°F(°C)	-4~75.2(-20~24)		

## Notes:

Capacities are based on the following conditions:

Cooling: Indoor temperature 27°C(80.6°F) DB/19°C(66.2°F) WB; Outdoor temperature 35°C(95°F) DB/24°C(75.2°F) WB.

Heating: Indoor temperature 20°C(68°F) DB/15°C(59°F) WB; Outdoor temperature 7°C(44.6°F) DB/6°C(42.8°F) WB.

Piping length: Interconnecting piping length is 7.5m (24.6ft), level difference is zero.

Connection piping diameter is based on the condition that the total equivalent liquid length is less than 90m (295.2ft). When the total equivalent liquid length is more than 90m (295.2ft), please refer to technical manual to choose the connection piping diameter.

Sound values are measured in a semi-anechoic room, at a position 1m (3.28ft) in front of the unit and 1.3m (4.26ft) above the floor.

## Combination unit specifications

HP		42	44	46	
Model	Combination Unit	MVD-V5X1175W/V2GN1	MVD-V5X1230W/V2GN1	MVD-V5X1285W/V2GN1	
	Independent Unit	MVD-V5X560W/V2GN1	MVD-V5X615W/V2GN1	MVD-V5X335W/V2GN1	
		MVD-V5X615W/V2GN1	MVD-V5X615W/V2GN1	MVD-V5X335W/V2GN1	
		-	-	MVD-V5X615W/V2GN1	
Power source	V-Ph-Hz	380~415V 3N 50Hz/60Hz			
Cooling	Capacity	kW	117.5	123.0	128.5
		RT	33.6	35.1	36.6
		kBtu/h	400.9	419.6	438.4
		kcal/h	101,050	105,780	110,510
	Power input	kW	35.44	37.54	36.19
EER	kW/kW	3.32	3.28	3.55	
Heating	Capacity	kW	132.0	138.0	144.0
		RT	37.7	39.4	41.1
		kBtu/h	450.3	470.8	491.4
		kcal/h	113,520	118,680	123,840
	Power input	kW	33.84	35.72	35.5
COP	kW/kW	3.90	3.86	4.06	
Max. input consumption	W	48232	48232	49092	
Max. current	A	84	84	83.2	
DC inverter compressor	Model	E705DHD-72D2YGx4		E705DHD-72D2YGx4	E705DHD-72D2YGx4
	Quantity	4.0		4.0	4.0
	Type	DC inverter		DC inverter	DC inverter
	Brand	Hitachi		Hitachi	Hitachi
	Capacity	kW	(23.25x2)+(23.25x2)	(23.25x2)x2	23.25x2+23.25x2
		kBtu/h	(79.3x2)+(79.3x2)	(79.3x2)x2	79.3x2+79.3x2
	Crankcase heater	W	27.6x8	27.6x8	27.6x8
	Refrigerant oil type	FVC68D		FVC68D	FVC68D
Refrigerant oil charge	gal. (ml)	0.132x4(500x4)	0.132x4(500x4)	0.132x4(500x4)	
Outdoor fan motor	Model	WZDK560-38G(B)		WZDK560-38G(B)	WZDK560-38G(B)
	Type	DC motor		DC motor	DC motor
	Brand	Panasonic/Nidec		Panasonic/Nidec	Panasonic/Nidec
	Quantity	4.0		4.0	4.0
	Insulation class	E		E	E
	Safe class	IP23		IP23	IP23
	Input	W	(550+430)+(550+430)	(550+430)x2	580x2+(550+430)
	Output	W	(440+350)+(440+350)	(440+350)x2	465x2+(440+350)
Outdoor fan	Material	Plastic		Plastic	Plastic
	Type	Axial		Axial	Axial
	Fan Quantity	4		4	4
	External static pressure	in. W.G.(Pa)	0~0.08(0~20) (default)		
		in. W.G.(Pa)	0.08~0.24(20~60) (customized)		
Outdoor coil	Tube pitch(a) xrow pitch(b)	in.(mm)	7/8x3/4(22x19)	7/8x3/4(22x19)	7/8x3/4(22x19)
	Fin spacing	in.(mm)	1/16(1.6)	1/16(1.6)	1/16(1.6)
	Fin type	Hydrophilic aluminum			

	Tube outside diameter	in.(mm)	Φ5/16(Φ7.94)	Φ5/16(Φ7.94)	Φ5/16(Φ7.94)
	Tube type		Inner-grooved	Inner-grooved	Inner-grooved
Outdoor air flow		m <sup>3</sup> /h	32,000	32,000	40,000
		CFM	18,820	18,820	23,530
Sound pressure level		dB(A)	66	66	66
Connectable indoor unit	Total capacity	%	50-130	50-130	50-130
	Max. quantity		64	64	64
Outdoor unit	Dimension(W×H×D)	inch	(52-3/4×64-3/8×31-1/8)×2	(52-3/4×64-3/8×31-1/8)×2	(39×64-3/8×31-1/8)×2 +52-3/4×64-3/8×31-1/8
		mm	(1340×1635×790)×2	(1340×1635×790)×2	(990×1635×790)×2 +1340×1635×790
	Packing(W×H×D)	inch	(55-3/8×71-1/16×33-5/8)×2	(55-3/8×71-1/16×33-5/8)×2	(41-1/2×71-1/16×33-5/8)×2 +55-3/8×71-1/16×33-5/8
		mm	(1405×1805×855)×2	(1405×1805×855)×2	(1055×1805×855)×2 +1405×1805×855
	Net weight	lbs.(kg)	750+750(340+340)	750×2(340×2)	523×2+750(237×2+340)
	Gross weight	lbs.(kg)	790+790(358+358)	790×2(358×2)	556×2+790(252×2+358)
Refrigerant	Type		R410A	R410A	R410A
	Factory charged	lbs.(kg)	35+35(16+16)	35×2(16×2)	24×2+35(11×2+16)
Throttle type			EXV	EXV	EXV
Design pressure(High/low)		MPa	4.4/2.6	4.4/2.6	4.4/2.6
		psi	640/380	640/380	640/380
Pipe connections	Liquid pipe	in.(mm)	Φ3/4(Φ19.1)	Φ3/4(Φ19.1)	Φ3/4(Φ19.1)
	Gas pipe	in.(mm)	Φ1-1/2(Φ38.1)	Φ1-1/2(Φ38.1)	Φ1-1/2(Φ38.1)
	Oil balance pipe	in.(mm)	Φ5/16(Φ8)	Φ5/16(Φ8)	Φ5/16(Φ8)
Operating temperature range	Cooling	°F(°C)	23~118.4(-5~48)		
	Heating	°F(°C)	-4~75.2(-20~24)		

## Notes:

Capacities are based on the following conditions:

Cooling: Indoor temperature 27°C(80.6°F) DB/19°C(66.2°F) WB; Outdoor temperature 35°C(95°F) DB/24°C(75.2°F) WB.

Heating: Indoor temperature 20°C(68°F) DB/15°C(59°F) WB; Outdoor temperature 7°C(44.6°F) DB/6°C(42.8°F) WB.

Piping length: Interconnecting piping length is 7.5m (24.6ft), level difference is zero.

Connection piping diameter is based on the condition that the total equivalent liquid length is less than 90m (295.2ft). When the total equivalent liquid length is more than 90m (295.2ft), please refer to technical manual to choose the connection piping diameter.

Sound values are measured in a semi-anechoic room, at a position 1m (3.28ft) in front of the unit and 1.3m (4.26ft) above the floor.

## Combination unit specifications

HP		48	50	52		
Model	Combination Unit		MVD-V5X1345W/V2GN1	MVD-V5X1395W/V2GN1	MVD-V5X1455W/V2GN1	
	Independent Unit			MVD-V5X280W/V2GN1	MVD-V5X280W/V2GN1	MVD-V5X280W/V2GN1
				MVD-V5X450W/V2GN1	MVD-V5X500W/V2GN1	MVD-V5X560W/V2GN1
				MVD-V5X615W/V2GN1	MVD-V5X615W/V2GN1	MVD-V5X615W/V2GN1
Power source		V-Ph-Hz	380~415V 3N 50Hz/60Hz			
Cooling	Capacity	kW	134.5	139.5	145.5	
		RT	38.4	39.9	41.6	
		kBtu/h	458.8	475.9	496.4	
		kcal/h	115,670	119,970	125,130	
	Power input	kW	38.62	40.26	42.46	
	EER	kW/kW	3.48	3.46	3.43	
Heating	Capacity	kW	150.5	156.5	163.5	
		RT	42.8	44.6	46.6	
		kBtu/h	513.5	534.0	557.8	
		kcal/h	129,430	134,590	140,610	
	Power input	kW	37.52	39.2	41.03	
	COP	kW/kW	4.01	3.99	3.98	
Max. input consumption		W	51656	53806	59592	
Max. current		A	87.7	90.8	103.8	
DC inverter compressor	Model		E655DHD-65D2YG+ E405DHD-42D2YG×2+ E705DHD-72D2YG×2	E655DHD-65D2YG+ E405DHD-36D2YG+ E705DHD-72D2YG×3	E655DHD-65D2YG+ E705DHD-72D2YG×4	
	Quantity		5.0	5.0	5.0	
	Type		DC inverter	DC inverter	DC inverter	
	Brand		Hitachi	Hitachi	Hitachi	
	Capacity	kW	21.06+(13.8×2) +(23.25×2)	21.06+(11.8+23.25) +(23.25×2)	21.06+(23.25×2) +(23.25×2)	
		kBtu/h	71.9+(47.1×2) +(79.3×2)	71.9+(40.3+79.3) +(79.3×2)	71.9+(79.3×2) +(79.3×2)	
	Crankcase heater	W	27.6×10	27.6×10	27.6×10	
	Refrigerant oil type		FVC68D	FVC68D	FVC68D	
Refrigerant oil charge	gal. (ml)	0.132×5(500×5)	0.132×5(500×5)	0.132×5(500×5)		
Outdoor fan motor	Model		WZDK560-38G(B)	WZDK560-38G(B)	WZDK560-38G(B)	
	Type		DC motor	DC motor	DC motor	
	Brand		Panasonic/Nidec	Panasonic/Nidec	Panasonic/Nidec	
	Quantity		5.0	5.0	5.0	
	Insulation class		E	E	E	
	Safe class		IP23	IP23	IP23	
	Input	W	580+(360+290) +(550+430)	580+(520+440) +(550+430)	580+(550+430) +(550+430)	
	Output	W	465+(290+230) +(440+350)	465+(420+350) +(440+350)	465+(440+350) +(440+350)	
Outdoor fan	Material		Plastic	Plastic	Plastic	
	Type		Axial	Axial	Axial	
	Fan Quantity		5	5	5	
	External static pressure	in. W.G. (Pa)	0~0.08(0~20) (default)			
		in. W.G. (Pa)	0.08~0.24(20~60) (customized)			

Outdoor coil	Tube pitch(a) x row pitch(b)	in.(mm)	7/8x3/4(22x19)	7/8x3/4(22x19)	7/8x3/4(22x19)	
	Fin spacing	in.(mm)	1/16(1.6)	1/16(1.6)	1/16(1.6)	
	Fin type	Hydrophilic aluminum				
	Tube outside diameter	in.(mm)	Φ5/16(Φ7.94)	Φ5/16(Φ7.94)	Φ5/16(Φ7.94)	
	Tube type	Inner-grooved				
Outdoor air flow		m <sup>3</sup> /h	42,000	44,000	44,000	
		CFM	24,710	25,880	25,880	
Sound pressure level		dB(A)	67	67	67	
Connectable indoor unit	Total capacity	%	50-130	50-130	50-130	
	Max. quantity	64				
Outdoor unit	Dimension(WxHxD)	inch	39x64-3/8x31-1/8 +52-3/4x64-3/8x31-1/8 +52-3/4x64-3/8x31-1/8	39x64-3/8x31-1/8 +52-3/4x64-3/8x31-1/8 +52-3/4x64-3/8x31-1/8	39x64-3/8x31-1/8 +52-3/4x64-3/8x31-1/8 +52-3/4x64-3/8x31-1/8	
		mm	990x1635x790 +1340x1635x790 +1340x1635x790	990x1635x790 +1340x1635x790 +1340x1635x790	990x1635x790 +1340x1635x790 +1340x1635x790	
	Packing(WxHxD)	inch	41-1/2x71-1/16x33-5/8 +55-3/8x71-1/16x33-5/8 +55-3/8x71-1/16x33-5/8	41-1/2x71-1/16x33-5/8 +55-3/8x71-1/16x33-5/8 +55-3/8x71-1/16x33-5/8	41-1/2x71-1/16x33-5/8 +55-3/8x71-1/16x33-5/8 +55-3/8x71-1/16x33-5/8	
		mm	1055x1805x855 +1405x1805x855 +1405x1805x855	1055x1805x855 +1405x1805x855 +1405x1805x855	1055x1805x855 +1405x1805x855 +1405x1805x855	
	Net weight	lbs.(kg)	483+655+750 (219+297+340)	483+673+750 (219+305+340)	483+750+750 (219+340+340)	
	Gross weight	lbs.(kg)	516+695+790 (234+315+358)	516+712+790 (234+323+358)	516+790+790 (234+358+358)	
	Refrigerant	Type	R410A			
		Factory charged	lbs.(kg)	20+29+35(9+13+16)	20+29+35(9+13+16)	20+35+35(9+16+16)
Throttle type		EXV				
Design pressure(High/low)		MPa	4.4/2.6	4.4/2.6	4.4/2.6	
		psi	640/380	640/380	640/380	
Pipe connections	Liquid pipe	in.(mm)	Φ3/4(Φ19.1)	Φ3/4(Φ19.1)	Φ7/8(Φ22.2)	
	Gas pipe	in.(mm)	Φ1-1/2(Φ38.1)	Φ1-1/2(Φ38.1)	Φ1-5/8(Φ41.2)	
	Oil balance pipe	in.(mm)	Φ5/16(Φ8)	Φ5/16(Φ8)	Φ5/16(Φ8)	
Operating temperature range	Cooling	°F(°C)	23~118.4(-5~48)			
	Heating	°F(°C)	-4~75.2(-20~24)			

## Notes:

Capacities are based on the following conditions:

Cooling: Indoor temperature 27°C(80.6°F) DB/19°C(66.2°F) WB; Outdoor temperature 35°C(95°F) DB/24°C(75.2°F) WB.

Heating: Indoor temperature 20°C(68°F) DB/15°C(59°F) WB; Outdoor temperature 7°C(44.6°F) DB/6°C(42.8°F) WB.

Piping length: Interconnecting piping length is 7.5m (24.6ft), level difference is zero.

Connection piping diameter is based on the condition that the total equivalent liquid length is less than 90m (295.2ft). When the total equivalent liquid length is more than 90m (295.2ft), please refer to technical manual to choose the connection piping diameter.

Sound values are measured in a semi-anechoic room, at a position 1m (3.28ft) in front of the unit and 1.3m (4.26ft) above the floor.



## Combination unit specifications

HP		54	56	58	
Model	Combination Unit	MVD-V5X1510W/V2GN1	MVD-V5X1565W/V2GN1	MVD-V5X1615W/V2GN1	
	Independent Unit	MVD-V5X280W/V2GN1	MVD-V5X335W/V2GN1	MVD-V5X500W/V2GN1	
		MVD-V5X615W/V2GN1	MVD-V5X615W/V2GN1	MVD-V5X500W/V2GN1	
		MVD-V5X615W/V2GN1	MVD-V5X615W/V2GN1	MVD-V5X615W/V2GN1	
Power source	V-Ph-Hz	380~415V 3N 50Hz/60Hz			
Cooling	Capacity	kW	151.0	156.5	161.5
		RT	43.1	44.6	46.2
		kBtu/h	515.1	533.9	551.0
		kcal/h	129,860	134,590	138,890
	Power input	kW	44.56	46.25	47.71
	EER	kW/kW	3.39	3.38	3.39
Heating	Capacity	kW	169.5	175.5	181.0
		RT	48.3	50.1	51.7
		kBtu/h	578.3	598.8	617.6
		kcal/h	145,770	150,930	155,660
	Power input	kW	42.91	44.54	46.16
	COP	kW/kW	3.95	3.94	3.92
Max. input consumption	W	59592	60720	60776	
Max. current	A	103.8	104.6	100	
DC inverter compressor	Model	E655DHD-65D2YG+ E705DHD-72D2YGx4	E705DHD-72D2YGx5	E405DHD-36D2YGx2+ E705DHD-72D2YGx4	
	Quantity	5.0	5.0	6.0	
	Type	DC inverter	DC inverter	DC inverter	
	Brand	Hitachi	Hitachi	Hitachi	
	Capacity	kW	21.06+(23.25x2)x2	23.25+(23.25x2)x2	(11.8+23.25)x2+23.25x2
		kBtu/h	71.9+(79.3x2)x2	79.3+(79.3x2)x2	(40.3+79.3)x2+79.3x2
	Crankcase heater	W	27.6x10	27.6x10	27.6x12
	Refrigerant oil type		FVC68D	FVC68D	FVC68D
Refrigerant oil charge	gal. (ml)	0.132x5(500x5)	0.132x5(500x5)	0.132x6(500x6)	
Outdoor fan motor	Model	WZDK560-38G(B)	WZDK560-38G(B)	WZDK560-38G(B)	
	Type	DC motor	DC motor	DC motor	
	Brand	Panasonic/Nidec	Panasonic/Nidec	Panasonic/Nidec	
	Quantity	5.0	5.0	6.0	
	Insulation class	E	E	E	
	Safe class	IP23	IP23	IP23	
	Input	W	580+(550+430)x2	580+(550+430)x2	(520+440)x2+(550+430)
	Output	W	465+(440+350)x2	465+(440+350)x2	(420+350)x2+(440+350)
Outdoor fan	Material	Plastic	Plastic	Plastic	
	Type	Axial	Axial	Axial	
	Fan Quantity	5	5	6	
	External static pressure	in. W.G. (Pa)	0~0.08(0~20) (default)		
		in. W.G. (Pa)	0.08~0.24(20~60) (customized)		
Outdoor coil	Tube pitch(a) xrow pitch(b)	in.(mm)	7/8x3/4(22x19)	7/8x3/4(22x19)	7/8x3/4(22x19)

	Fin spacing	in.(mm)	1/16(1.6)	1/16(1.6)	1/16(1.6)
	Fin type		Hydrophilic aluminum		
	Tube outside diameter	in.(mm)	Φ5/16(Φ7.94)	Φ5/16(Φ7.94)	Φ5/16(Φ7.94)
	Tube type		Inner-grooved	Inner-grooved	Inner-grooved
Outdoor air flow		m <sup>3</sup> /h	44,000	44,000	48,000
		CFM	25,880	25,880	28,230
Sound pressure level		dB(A)	67	67	68
Connectable indoor unit	Total capacity	%	50-130	50-130	50-130
	Max. quantity		64	64	64
Outdoor unit	Dimension (W×H×D)	inch	39×64-3/8×31-1/8+ (52-3/4×64-3/8×31-1/8)×2	39×64-3/8×31-1/8+ (52-3/4×64-3/8×31-1/8)×2	(52-3/4×64-3/8×31-1/8)×2 +52-3/4×64-3/8×31-1/8
		mm	990×1635×790+ (1340×1635×790)×2	990×1635×790+ (1340×1635×790)×2	(1340×1635×790)×2 +1340×1635×790
	Packing (W×H×D)	inch	41-1/2×71-1/16×33-5/8+ (55-3/8×71-1/16×33-5/8)×2	41-1/2×71-1/16×33-5/8+ (55-3/8×71-1/16×33-5/8)×2	(55-3/8×71-1/16×33-5/8)×2 +55-3/8×71-1/16×33-5/8
		mm	1055×1805×855+ (1405×1805×855)×2	1055×1805×855+ (1405×1805×855)×2	(1405×1805×855)×2 +1405×1805×855
	Net weight	lbs.(kg)	483+750×2(219+340×2)	523+750×2(237+340×2)	673×2+750(305×2+340)
	Gross weight	lbs.(kg)	516+790×2(234+358×2)	556+790×2(252+358×2)	712×2+323(323×2+358)
Refrigerant	Type		R410A	R410A	R410A
	Factory charged	lbs.(kg)	20+35×2(9+16×2)	24+35×2(11+16×2)	29×2+35(13×2+16)
Throttle type			EXV	EXV	EXV
Design pressure(High/low)		MPa	4.4/2.6	4.4/2.6	4.4/2.6
		psi	640/380	640/380	640/380
Pipe connections	Liquid pipe	in.(mm)	Φ7/8(Φ22.2)	Φ7/8(Φ22.2)	Φ7/8(Φ22.2)
	Gas pipe	in.(mm)	Φ1-5/8(Φ41.2)	Φ1-5/8(Φ41.2)	Φ1-5/8(Φ41.2)
	Oil balance pipe	in.(mm)	Φ5/16(Φ8)	Φ5/16(Φ8)	Φ5/16(Φ8)
Operating temperature range	Cooling	°F(°C)	23~118.4(-5~48)		
	Heating	°F(°C)	-4~75.2(-20~24)		

## Notes:

Capacities are based on the following conditions:

Cooling: Indoor temperature 27°C (80.6°F) DB/19°C (66.2°F) WB; Outdoor temperature 35°C (95°F) DB/24°C (75.2°F) WB.

Heating: Indoor temperature 20°C (68°F) DB/15°C (59°F) WB; Outdoor temperature 7°C (44.6°F) DB/6°C (42.8°F) WB.

Piping length: Interconnecting piping length is 7.5m (24.6ft), level difference is zero.

Connection piping diameter is based on the condition that the total equivalent liquid length is less than 90m (295.2ft). When the total equivalent liquid length is more than 90m (295.2ft), please refer to technical manual to choose the connection piping diameter.

Sound values are measured in a semi-anechoic room, at a position 1m (3.28ft) in front of the unit and 1.3m (4.26ft) above the floor.

## Combination unit specifications

HP		60	62	64	
Model	Combination Unit	MVD-V5X1680W/V2GN1	MVD-V5X1730W/V2GN1	MVD-V5X1790W/V2GN1	
	Independent Unit	MVD-V5X450W/V2GN1	MVD-V5X500W/V2GN1	MVD-V5X560W/V2GN1	
		MVD-V5X615W/V2GN1	MVD-V5X615W/V2GN1	MVD-V5X615W/V2GN1	
		MVD-V5X615W/V2GN1	MVD-V5X615W/V2GN1	MVD-V5X615W/V2GN1	
Power source		V-Ph-Hz	380~415V 3N 50Hz/60Hz		
Cooling	Capacity	kW	168.0	173.0	179.0
		RT	47.9	49.4	51.1
		kBtu/h	573.1	590.2	610.7
		kcal/h	144,480	148,780	153,940
	Power input	kW	50.37	52.01	54.21
EER	kW/kW	3.34	3.33	3.30	
Heating	Capacity	kW	188.0	194.0	201.0
		RT	53.6	55.4	57.4
		kBtu/h	641.4	661.9	685.7
		kcal/h	161,680	166,840	172,860
	Power input	kW	48.19	49.87	51.7
COP	kW/kW	3.90	3.89	3.89	
Max. input consumption		W	64412	66562	72348
Max. current		A	109.9	113	126
DC inverter compressor	Model		E405DHD-42D2YG×2+ E705DHD-72D2YG×4	E405DHD-36D2YG+ E705DHD-72D2YG×6	E705DHD-72D2YG×6
	Quantity		6.0	6.0	6.0
	Type		DC inverter	DC inverter	DC inverter
	Brand		Hitachi	Hitachi	Hitachi
	Capacity	kW	13.8×2+(23.25×2)×2	(11.8+23.25)+(23.25×2)×2	23.25×2+(23.25×2)×2
		kBtu/h	47.1×2+(79.3×2)×2	(40.3+79.3)+(79.3×2)×2	79.3×2+(79.3×2)×2
	Crankcase heater		W	27.6×12	27.6×12
	Refrigerant oil type		FVC68D	FVC68D	FVC68D
Refrigerant oil charge		gal. (ml)	0.132×6(500×6)	0.132×6(500×6)	
Outdoor fan motor	Model		WZDK560-38G(B)	WZDK560-38G(B)	WZDK560-38G(B)
	Type		DC motor	DC motor	DC motor
	Brand		Panasonic/Nidec	Panasonic/Nidec	Panasonic/Nidec
	Quantity		6.0	6.0	6.0
	Insulation class		E	E	E
	Safe class		IP23	IP23	IP23
	Input	W	(360+290)+(550+430)×2	(520+440)+(550+430)×2	(550+430)+(550+430)×2
	Output	W	(290+230)+(440+350)×2	(420+350)+(440+350)×2	(440+350)+(440+350)×2
Outdoor fan	Material		Plastic	Plastic	Plastic
	Type		Axial	Axial	Axial
	Fan Quantity		6	6	6
	External static pressure	in. W.G. (Pa)	0~0.08(0~20) (default)		
in. W.G. (Pa)		0.08~0.24(20~60) (customized)			
Outdoor coil	Tube pitch(a) ×row pitch(b)	in.(mm)	7/8×3/4(22×19)	7/8×3/4(22×19)	7/8×3/4(22×19)
	Fin spacing	in.(mm)	1/16(1.6)	1/16(1.6)	1/16(1.6)

Fin type			Hydrophilic aluminum		
Tube outside diameter	in.(mm)		Φ5/16(Φ7.94)	Φ5/16(Φ7.94)	Φ5/16(Φ7.94)
Tube type			Inner-grooved	Inner-grooved	Inner-grooved
Outdoor air flow		m <sup>3</sup> /h	46,000	48,000	48,000
		CFM	27,060	28,230	28,230
Sound pressure level		dB(A)	68	68	68
Connectable indoor unit	Total capacity	%	50-130	50-130	50-130
	Max. quantity		64	64	64
Outdoor unit	Dimension(W×H×D)	inch	52-3/4×64-3/8×31-1/8+ (52-3/4×64-3/8×31-1/8)×2	52-3/4×64-3/8×31-1/8+ (52-3/4×64-3/8×31-1/8)×2	52-3/4×64-3/8×31-1/8+ (52-3/4×64-3/8×31-1/8)×2
		mm	1340×1635×790+ (1340×1635×790)×2	1340×1635×790+ (1340×1635×790)×2	1340×1635×790+ (1340×1635×790)×2
	Packing(W×H×D)	inch	55-3/8×71-1/16×33-5/8+ (55-3/8×71-1/16×33-5/8)×2	55-3/8×71-1/16×33-5/8+ (55-3/8×71-1/16×33-5/8)×2	55-3/8×71-1/16×33-5/8+ (55-3/8×71-1/16×33-5/8)×2
		mm	1405×1805×855+ (1405×1805×855)×2	1405×1805×855+ (1405×1805×855)×2	1405×1805×855+ (1405×1805×855)×2
	Net weight	lbs.(kg)	655+750×2(297+340×2)	673+750×2(305+340×2)	750+750×2(340+340×2)
	Gross weight	lbs.(kg)	695+790×2(315+358×2)	712+790×2(323+358×2)	790+790×2(358+358×2)
Refrigerant	Type		R410A	R410A	R410A
	Factory charged	lbs.(kg)	29+35×2(13+16×2)	29+35×2(13+16×2)	35+35×2(16+16×2)
Throttle type			EXV	EXV	EXV
Design pressure(High/low)		MPa	4.4/2.6	4.4/2.6	4.4/2.6
		psi	640/380	640/380	640/380
Pipe connections	Liquid pipe	in.(mm)	Φ7/8(Φ22.2)	Φ7/8(Φ22.2)	Φ7/8(Φ22.2)
	Gas pipe	in.(mm)	Φ1-5/8(Φ41.2)	Φ1-5/8(Φ41.2)	Φ1-5/8(Φ41.2)
	Oil balance pipe	in.(mm)	Φ5/16(Φ8)	Φ5/16(Φ8)	Φ5/16(Φ8)
Operating temperature range	Cooling	°F(°C)	23~118.4(-5~48)		
	Heating	°F(°C)	-4~75.2(-20~24)		

## Notes:

Capacities are based on the following conditions:

Cooling: Indoor temperature 27°C(80.6°F) DB/19°C(66.2°F) WB; Outdoor temperature 35°C(95°F) DB/24°C(75.2°F) WB.

Heating: Indoor temperature 20°C(68°F) DB/15°C(59°F) WB; Outdoor temperature 7°C(44.6°F) DB/6°C(42.8°F) WB.

Piping length: Interconnecting piping length is 7.5m (24.6ft), level difference is zero.

Connection piping diameter is based on the condition that the total equivalent liquid length is less than 90m (295.2ft). When the total equivalent liquid length is more than 90m (295.2ft), please refer to technical manual to choose the connection piping diameter.

Sound values are measured in a semi-anechoic room, at a position 1m (3.28ft) in front of the unit and 1.3m (4.26ft) above the floor.

## Combination unit specifications

HP		66	68	70	
Model	Combination Unit		MVD-V5X1845W/V2GN1	MVD-V5X1900W/V2GN1	MVD-V5X1960W/V2GN1
	Independent Unit		MVD-V5X615W/V2GN1	MVD-V5X335W/V2GN1	MVD-V5X280W/V2GN1
			MVD-V5X615W/V2GN1	MVD-V5X335W/V2GN1	MVD-V5X450W/V2GN1
			MVD-V5X615W/V2GN1	MVD-V5X615W/V2GN1	MVD-V5X615W/V2GN1
			-	MVD-V5X615W/V2GN1	MVD-V5X615W/V2GN1
Power source		V-Ph-Hz	380~415V 3N 50Hz/60Hz		
Cooling	Capacity	kW	184.5	190.0	196.0
		RT	52.7	54.1	55.9
		kBtu/h	629.4	648.2	668.6
		kcal/h	158,670	163,400	168,560
	Power input	kW	56.31	54.96	57.39
EER	kW/kW	3.28	3.46	3.42	
Heating	Capacity	kW	207.0	213.0	219.5
		RT	59.1	60.8	62.5
		kBtu/h	706.2	726.8	748.9
		kcal/h	178,020	183,180	188,770
	Power input	kW	53.58	53.36	55.38
COP	kW/kW	3.86	3.99	3.96	
Max. input consumption		W	72348	73208	75772
Max. current		A	126	125.2	129.7
DC inverter compressor	Model		E705DHD-72D2YG×6	E705DHD-72D2YG×6	E655DHD-65D2YG+ E405DHD-42D2YG×2+ E705DHD-72D2YG×4
	Quantity		6.0	6.0	7.0
	Type		DC inverter	DC inverter	DC inverter
	Brand		Hitachi	Hitachi	Hitachi
	Capacity	kW	(23.25×2)×3	23.25×2+(23.25×2)×2	21.06+13.8×2+23.25×2
		kBtu/h	(79.3×2)×3	79.3×2+(79.3×2)×2	71.9+47.1×2+79.3×2
	Crankcase heater	W	27.6×12	27.6×12	27.6×14
	Refrigerant oil type		FVC68D	FVC68D	FVC68D
Refrigerant oil charge	gal. (ml)	0.132×6(500×6)	0.132×6(500×6)	0.132×7(500×7)	
Outdoor fan motor	Model		WZDK560-38G(B)	WZDK560-38G(B)	WZDK560-38G(B)
	Type		DC motor	DC motor	DC motor
	Brand		Panasonic/Nidec	Panasonic/Nidec	Panasonic/Nidec
	Quantity		6.0	6.0	7.0
	Insulation class		E	E	E
	Safe class		IP23	IP23	IP23
	Input	W	(550+430)×3	580×2+(550+430)×2	580+(360+290)+(550+430)×2
	Output	W	(440+350)×3	465×2+(440+350)×2	465+(290+230)+(440+350)×2
Outdoor fan	Material		Plastic	Plastic	Plastic
	Type		Axial	Axial	Axial
	Fan Quantity		6	6	7
	External static pressure	in. W.G. (Pa)	0~0.08(0~20) (default)		
in. W.G. (Pa)		0.08~0.24(20~60) (customized)			

Outdoor coil	Tube pitch(a) xrow pitch(b)	in.(mm)	7/8x3/4(22x19)	7/8x3/4(22x19)	7/8x3/4(22x19)
	Fin spacing	in.(mm)	1/16(1.6)	1/16(1.6)	1/16(1.6)
	Fin type	Hydrophilic aluminum			
	Tube outside diameter	in.(mm)	Φ5/16(Φ7.94)	Φ5/16(Φ7.94)	Φ5/16(Φ7.94)
	Tube type	Inner-grooved			
Outdoor air flow		m <sup>3</sup> /h	48,000	56,000	58,000
		CFM	28,230	32,940	34,120
Sound pressure level		dB(A)	68	68	69
Connectable indoor unit	Total capacity	%	50-130	50-130	50-130
	Max. quantity	64			
Outdoor unit	Dimension (W×H×D)	inch	(52-3/4×64-3/8×31-1/8)×3	(39×64-3/8×31-1/8)×2+ (52-3/4×64-3/8×31-1/8)×2	39×64-3/8×31-1/8 +52-3/4×64-3/8×31-1/8 +52-3/4×64-3/8×31-1/8
		mm	(1340×1635×790)×3	(990×1635×790)×2+ (1340×1635×790)×2	990×1635×790 +1340×1635×790 +1340×1635×790
	Packing (W×H×D)	inch	(55-3/8×71-1/16×33-5/8)×3	(41-1/2×71-1/16×33-5/8)×2+ (55-3/8×71-1/16×33-5/8)×2	41-1/2×71-1/16×33-5/8 +55-3/8×71-1/16×33-5/8 +55-3/8×71-1/16×33-5/8
		mm	(1405×1805×855)×3	(1055×1805×855)×2+ (1405×1805×855)×2	1055×1805×855 +1405×1805×855 +1405×1805×855
	Net weight	lbs.(kg)	750×3(340×3)	523×2+750×2(237×2+340×2)	483+655+750(219+297+340)
	Gross weight	lbs.(kg)	790×3(358×3)	556×2+790×2(252×2+358×2)	516+695+790(234+315+358)
Refrigerant	Type	R410A			
	Factory charged	lbs.(kg)	35×3(16×3)	24×2+35×2(11×2+16×2)	20+29+35(9+13+16)
Throttle type		EXV			
Design pressure(High/low)		MPa	4.4/2.6	4.4/2.6	4.4/2.6
		psi	640/380	640/380	640/380
Pipe connections	Liquid pipe	in.(mm)	Φ7/8(Φ22.2)	Φ1(Φ25.4)	Φ1(Φ25.4)
	Gas pipe	in.(mm)	Φ1-5/8(Φ41.2)	Φ1-3/4(Φ44.5)	Φ1-3/4(Φ44.5)
	Oil balance pipe	in.(mm)	Φ5/16(Φ8)	Φ5/16(Φ8)	Φ5/16(Φ8)
Operating temperature range	Cooling	°F(°C)	23~118.4(-5~48)		
	Heating	°F(°C)	-4~75.2(-20~24)		

## Notes:

Capacities are based on the following conditions:

Cooling: Indoor temperature 27°C(80.6°F) DB/19°C(66.2°F) WB; Outdoor temperature 35°C(95°F) DB/24°C(75.2°F) WB.

Heating: Indoor temperature 20°C(68°F) DB/15°C(59°F) WB; Outdoor temperature 7°C(44.6°F) DB/6°C(42.8°F) WB.

Piping length: Interconnecting piping length is 7.5m (24.6ft), level difference is zero.

Connection piping diameter is based on the condition that the total equivalent liquid length is less than 90m (295.2ft). When the total equivalent liquid length is more than 90m (295.2ft), please refer to technical manual to choose the connection piping diameter.

Sound values are measured in a semi-anechoic room, at a position 1m (3.28ft) in front of the unit and 1.3m (4.26ft) above the floor.

## Combination unit specifications

HP		72	74	76	
Model	Combination Unit	MVD-V5X2010W/V2GN1	MVD-V5X2070W/V2GN1	MVD-V5X2125W/V2GN1	
	Independent Unit	MVD-V5X280W/V2GN1	MVD-V5X280W/V2GN1	MVD-V5X280W/V2GN1	
		MVD-V5X500W/V2GN1	MVD-V5X560W/V2GN1	MVD-V5X615W/V2GN1	
		MVD-V5X615W/V2GN1	MVD-V5X615W/V2GN1	MVD-V5X615W/V2GN1	
		MVD-V5X615W/V2GN1	MVD-V5X615W/V2GN1	MVD-V5X615W/V2GN1	
Power source	V-Ph-Hz	380~415V 3N 50Hz/60Hz			
Cooling	Capacity	kW	201.0	207.0	212.5
		RT	57.4	59.1	60.7
		kBtu/h	685.7	706.2	724.9
		kcal/h	172,860	178,020	182,750
	Power input	kW	59.03	61.23	63.33
EER	kW/kW	3.41	3.38	3.36	
Heating	Capacity	kW	225.5	232.5	238.5
		RT	64.3	66.3	68.0
		kBtu/h	769.4	793.2	813.7
		kcal/h	193,930	199,950	205,110
	Power input	kW	57.06	58.89	60.77
COP	kW/kW	3.95	3.95	3.92	
Max. input consumption	W	77922	83708	83708	
Max. current	A	132.8	145.8	145.8	
DC inverter compressor	Model	E655DHD-65D2YG+ E405DHD-36D2YG+ E705DHD-72D2YGx5	E655DHD-65D2YG+ E705DHD-72D2YGx6	E655DHD-65D2YG+ E705DHD-72D2YGx6	
	Quantity	7.0	7.0	7.0	
	Type	DC inverter	DC inverter	DC inverter	
	Brand	Hitachi	Hitachi	Hitachi	
	Capacity	kW	21.06+(11.8+23.25)+23.25x2	21.06+23.25x2+23.25x2	21.06+(23.25x2)x3
		kBtu/h	71.9+(40.3+79.3)+79.3x2	71.9+79.3x2+79.3x2	71.9+(79.3x2)x3
	Crankcase heater	W	27.6x14	27.6x14	27.6x14
	Refrigerant oil type		FVC68D	FVC68D	FVC68D
Refrigerant oil charge	gal. (ml)	0.132x7(500x7)	0.132x7(500x7)	0.132x7(500x7)	
Outdoor fan motor	Model	WZDK560-38G(B)	WZDK560-38G(B)	WZDK560-38G(B)	
	Type	DC motor	DC motor	DC motor	
	Brand	Panasonic/Nidec	Panasonic/Nidec	Panasonic/Nidec	
	Quantity	7.0	7.0	7.0	
	Insulation class	E	E	E	
	Safe class	IP23	IP23	IP23	
	Input	W	580+(520+440)+(550+430)x2	580+(550+430)+(550+430)x2	580+(550+430)x3
	Output	W	465+(420+350)+(440+350)x2	465+(440+350)+(440+350)x2	465+(440+350)x3
Outdoor fan	Material	Plastic	Plastic	Plastic	
	Type	Axial	Axial	Axial	
	Fan Quantity	7	7	7	
	External static pressure	in. W.G. (Pa)	0~0.08(0~20) (default)		
in. W.G. (Pa)		0.08~0.24(20~60) (customized)			

Outdoor coil	Tube pitch(a) xrow pitch(b)	in.(mm)	7/8x3/4(22x19)	7/8x3/4(22x19)	7/8x3/4(22x19)
	Fin spacing	in.(mm)	1/16(1.6)	1/16(1.6)	1/16(1.6)
	Fin type	Hydrophilic aluminum			
	Tube outside diameter	in.(mm)	Φ5/16(Φ7.94)	Φ5/16(Φ7.94)	Φ5/16(Φ7.94)
	Tube type	Inner-grooved			
Outdoor air flow		m <sup>3</sup> /h	60,000	60,000	60,000
		CFM	35,290	35,290	35,290
Sound pressure level		dB(A)	69	69	69
Connectable indoor unit	Total capacity	%	50-130	50-130	50-130
	Max. quantity	64			
Outdoor unit	Dimension (W×H×D)	inch	39×64-3/8×31-1/8 +52-3/4×64-3/8×31-1/8 +52-3/4×64-3/8×31-1/8	39×64-3/8×31-1/8 +52-3/4×64-3/8×31-1/8 +52-3/4×64-3/8×31-1/8	39×64-3/8×31-1/8+ (52-3/4×64-3/8×31-1/8)×3
		mm	990×1635×790 +1340×1635×790 +1340×1635×790	990×1635×790 +1340×1635×790 +1340×1635×790	990×1635×790+ (1340×1635×790)×3
	Packing (W×H×D)	inch	41-1/2×71-1/16×33-5/8 +55-3/8×71-1/16×33-5/8 +55-3/8×71-1/16×33-5/8	41-1/2×71-1/16×33-5/8 +55-3/8×71-1/16×33-5/8 +55-3/8×71-1/16×33-5/8	41-1/2×71-1/16×33-5/8+ (55-3/8×71-1/16×33-5/8)×3
		mm	1055×1805×855 +1405×1805×855 +1405×1805×855	1055×1805×855 +1405×1805×855 +1405×1805×855	1055×1805×855+ (1405×1805×855)×3
	Net weight	lbs.(kg)	483+673+750(219+305+340)	483+750+750(219+340+340)	483+750×3(219+340×3)
	Gross weight	lbs.(kg)	516+712+790(234+323+358)	516+790+790(234+358+358)	516+790×3(234+358×3)
Refrigerant	Type	R410A			
	Factory charged	lbs.(kg)	20+29+35(9+13+16)	20+35+35(9+16+16)	20+35×3(9+16×3)
Throttle type		EXV			
Design pressure(High/low)		MPa	4.4/2.6	4.4/2.6	4.4/2.6
		psi	640/380	640/380	640/380
Pipe connections	Liquid pipe	in.(mm)	Φ1(Φ25.4)	Φ1(Φ25.4)	Φ1(Φ25.4)
	Gas pipe	in.(mm)	Φ1-3/4(Φ44.5)	Φ1-3/4(Φ44.5)	Φ1-3/4(Φ44.5)
	Oil balance pipe	in.(mm)	Φ5/16(Φ8)	Φ5/16(Φ8)	Φ5/16(Φ8)
Operating temperature range	Cooling	°F(°C)	23~118.4(-5~48)		
	Heating	°F(°C)	-4~75.2(-20~24)		

## Notes:

Capacities are based on the following conditions:

Cooling: Indoor temperature 27°C (80.6°F) DB/19°C (66.2°F) WB; Outdoor temperature 35°C (95°F) DB/24°C (75.2°F) WB.

Heating: Indoor temperature 20°C (68°F) DB/15°C (59°F) WB; Outdoor temperature 7°C (44.6°F) DB/6°C (42.8°F) WB.

Piping length: Interconnecting piping length is 7.5m (24.6ft), level difference is zero.

Connection piping diameter is based on the condition that the total equivalent liquid length is less than 90m (295.2ft). When the total equivalent liquid length is more than 90m (295.2ft), please refer to technical manual to choose the connection piping diameter.

Sound values are measured in a semi-anechoic room, at a position 1m (3.28ft) in front of the unit and 1.3m (4.26ft) above the floor.



## Combination unit specifications

HP		78	80	82	
Model	Combination Unit		MVD-V5X2180W/V2GN1	MVD-V5X2230W/V2GN1	MVD-V5X2295W/V2GN1
	Independent Unit	MVD-V5X335W/V2GN1		MVD-V5X500W/V2GN1	MVD-V5X450W/V2GN1
		MVD-V5X500W/V2GN1		MVD-V5X500W/V2GN1	MVD-V5X615W/V2GN1
		MVD-V5X615W/V2GN1		MVD-V5X615W/V2GN1	MVD-V5X615W/V2GN1
		MVD-V5X615W/V2GN1		MVD-V5X615W/V2GN1	MVD-V5X615W/V2GN1
Power source		V-Ph-Hz	380~415V 3N 50Hz/60Hz		
Cooling	Capacity	kW	218.0	223.0	229.5
		RT	62.2	63.7	65.5
		kBtu/h	743.7	760.8	782.9
		kcal/h	187,480	191,780	197,370
	Power input	kW	65.02	66.48	69.14
EER	kW/kW	3.35	3.35	3.32	
Heating	Capacity	kW	244.5	250.0	257.0
		RT	69.8	71.4	73.3
		kBtu/h	834.2	853.0	876.8
		kcal/h	210,270	215,000	221,020
	Power input	kW	62.4	64.02	66.05
COP	kW/kW	3.92	3.91	3.89	
Max. input consumption		W	84836	84892	88528
Max. current		A	146.6	142	151.9
DC inverter compressor	Model		E705DHD-72D2YG×7	E405DHD-36D2YG×2+ E705DHD-72D2YG×6	E405DHD-42D2YG×2+ E705DHD-72D2YG×6
	Quantity		7.0	8.0	8.0
	Type		DC inverter	DC inverter	DC inverter
	Brand		Hitachi	Hitachi	Hitachi
	Capacity	kW	23.25+(23.25×2)×3	(11.8+23.25)×2+(23.25×2)×2	13.8×2+(23.25×2)×3
		kBtu/h	79.3+(79.3×2)×3	(40.3+79.3)×2+(79.3×2)×2	47.1×2+(79.3×2)×3
	Crankcase heater	W	27.6×14	27.6×16	27.6×16
	Refrigerant oil type		FVC68D	FVC68D	FVC68D
Refrigerant oil charge	gal. (ml)	0.132×7(500×7)	0.132×8(500×8)	0.132×8(500×8)	
Outdoor fan motor	Model		WZDK560-38G(B)	WZDK560-38G(B)	WZDK560-38G(B)
	Type		DC motor	DC motor	DC motor
	Brand		Panasonic/Nidec	Panasonic/Nidec	Panasonic/Nidec
	Quantity		7.0	8.0	8.0
	Insulation class		E	E	E
	Safe class		IP23	IP23	IP23
	Input	W	580+(550+430)×3	(520+440)×2+(550+430)×2	360+290+(550+430)×3
	Output	W	465+(440+350)×3	(420+350)×2+(440+350)×2	(290+230)+(440+350)×3
Outdoor fan	Material		Plastic	Plastic	Plastic
	Type		Axial	Axial	Axial
	Fan Quantity		7	8	8
	External static pressure	in. W.G. (Pa)	0~0.08(0~20) (default)		
in. W.G. (Pa)		0.08~0.24(20~60) (customized)			
Outdoor coil	Tube pitch(a)	in.(mm)	7/8×3/4(22×19)	7/8×3/4(22×19)	7/8×3/4(22×19)

	xrow pitch(b)				
	Fin spacing	in.(mm)	1/16(1.6)	1/16(1.6)	1/16(1.6)
	Fin type	Hydrophilic aluminum			
	Tube outside diameter	in.(mm)	Φ5/16(Φ7.94)	Φ5/16(Φ7.94)	Φ5/16(Φ7.94)
	Tube type	Inner-grooved			
Outdoor air flow		m <sup>3</sup> /h	60,000	64,000	62,000
		CFM	35,290	37,640	36,470
Sound pressure level		dB(A)	69	70	70
Connectable indoor unit	Total capacity	%	50-130	50-130	50-130
	Max. quantity	64		64	64
Outdoor unit	Dimension (W×H×D)	inch	39×64-3/8×31-1/8+ (52-3/4×64-3/8×31-1/8)×3	(52-3/4×64-3/8×31-1/8)×2 +(52-3/4×64-3/8×31-1/8)×2	52-3/4×64-3/8×31-1/8+ (52-3/4×64-3/8×31-1/8)×3
		mm	990×1635×790+ (1340×1635×790)×3	(1340×1635×790)×2 +(1340×1635×790)×2	1340×1635×790+ (1340×1635×790)×3
	Packing (W×H×D)	inch	41-1/2×71-1/16×33-5/8+ (55-3/8×71-1/16×33-5/8)×3	(55-3/8×71-1/16×33-5/8)×2 +(55-3/8×71-1/16×33-5/8)×2	55-3/8×71-1/16×33-5/8+ (55-3/8×71-1/16×33-5/8)×3
		mm	1055×1805×855+ (1405×1805×855)×3	(1405×1805×855)×2 +(1405×1805×855)×2	1405×1805×855+ (1405×1805×855)×3
	Net weight	lbs.(kg)	523+750×3(237+340×3)	673×2+750×2(305×2+340×2)	655+750×3(297+340×3)
	Gross weight	lbs.(kg)	556+790×3(252+358×3)	712×2+323×2(323×2+358×2)	695+790×3(315+358×3)
Refrigerant	Type	R410A			
	Factory charged	lbs.(kg)	24+35×3(11+16×3)	29×2+35×2(13×2+16×2)	29+35×3(13+16×3)
Throttle type		EXV			
Design pressure(High/low)		MPa	4.4/2.6	4.4/2.6	4.4/2.6
		psi	640/380	640/380	640/380
Pipe connections	Liquid pipe	in.(mm)	Φ1(Φ25.4)	Φ1(Φ25.4)	Φ1(Φ25.4)
	Gas pipe	in.(mm)	Φ1-3/4(Φ44.5)	Φ1-3/4(Φ44.5)	Φ1-3/4(Φ44.5)
	Oil balance pipe	in.(mm)	Φ5/16(Φ8)	Φ5/16(Φ8)	Φ5/16(Φ8)
Operating temperature range	Cooling	°F(°C)	23~118.4(-5~48)		
	Heating	°F(°C)	-4~75.2(-20~24)		

## Notes:

Capacities are based on the following conditions:

Cooling: Indoor temperature 27°C(80.6°F) DB/19°C(66.2°F) WB; Outdoor temperature 35°C(95°F) DB/24°C(75.2°F) WB.

Heating: Indoor temperature 20°C(68°F) DB/15°C(59°F) WB; Outdoor temperature 7°C(44.6°F) DB/6°C(42.8°F) WB.

Piping length: Interconnecting piping length is 7.5m (24.6ft), level difference is zero.

Connection piping diameter is based on the condition that the total equivalent liquid length is less than 90m (295.2ft). When the total equivalent liquid length is more than 90m (295.2ft), please refer to technical manual to choose the connection piping diameter.

Sound values are measured in a semi-anechoic room, at a position 1m (3.28ft) in front of the unit and 1.3m (4.26ft) above the floor.

## Combination unit specifications

HP		84	86	88	
Model	Combination Unit		MVD-V5X2345W/V2GN1	MVD-V5X2405W/V2GN1	MVD-V5X2460W/V2GN1
	Independent Unit	MVD-V5X500W/V2GN1		MVD-V5X560W/V2GN1	MVD-V5X615W/V2GN1
		MVD-V5X615W/V2GN1		MVD-V5X615W/V2GN1	MVD-V5X615W/V2GN1
		MVD-V5X615W/V2GN1		MVD-V5X615W/V2GN1	MVD-V5X615W/V2GN1
		MVD-V5X615W/V2GN1		MVD-V5X615W/V2GN1	MVD-V5X615W/V2GN1
Power source		V-Ph-Hz	380~415V 3N 50Hz/60Hz		
Cooling	Capacity	kW	234.5	240.5	246.0
		RT	67.0	68.7	70.3
		kBtu/h	800.0	820.5	839.2
		kcal/h	201,670	206,830	211,560
	Power input	kW	70.78	72.98	75.08
EER	kW/kW	3.31	3.30	3.28	
Heating	Capacity	kW	263.0	270.0	276.0
		RT	75.1	77.1	78.9
		kBtu/h	897.3	921.1	941.6
		kcal/h	226,180	232,200	237,360
	Power input	kW	67.73	69.56	71.44
COP	kW/kW	3.88	3.88	3.86	
Max. input consumption		W	90678	96464	96464
Max. current		A	155	168	168
DC inverter compressor	Model		E405DHD-36D2YG+ E705DHD-72D2YG×7	E705DHD-72D2YG×8	E705DHD-72D2YG×8
	Quantity		8.0	8.0	8.0
	Type		DC inverter	DC inverter	DC inverter
	Brand		Hitachi	Hitachi	Hitachi
	Capacity	kW	(11.8+23.25)+(23.25×2)×3	23.25×2+(23.25×2)×3	(23.25×2)×4
		kBtu/h	(40.3+79.3)+(79.3×2)×3	79.3×2+(79.3×2)×3	(79.3×2)×4
	Crankcase heater	W	27.6×16	27.6×16	27.6×16
	Refrigerant oil type		FVC68D	FVC68D	FVC68D
Refrigerant oil charge	gal. (ml)	0.132×8(500×8)	0.132×8(500×8)	0.132×8(500×8)	
Outdoor fan motor	Model		WZDK560-38G(B)	WZDK560-38G(B)	WZDK560-38G(B)
	Type		DC motor	DC motor	DC motor
	Brand		Panasonic/Nidec	Panasonic/Nidec	Panasonic/Nidec
	Quantity		8	8	8
	Insulation class		E	E	E
	Safe class		IP23	IP23	IP23
	Input	W	(520+440)+(550+430)×3	(550+430)+(550+430)×3	(550+430)×4
	Output	W	(420+350)+(440+350)×3	(440+350)+(440+350)×3	(440+350)×4
Outdoor fan	Material		Plastic	Plastic	Plastic
	Type		Axial	Axial	Axial
	Fan Quantity		8.0	8.0	8.0
	External static pressure	in. W.G. (Pa)	0~0.08(0~20) (default)		
in. W.G. (Pa)		0.08~0.24(20~60) (customized)			
Outdoor coil	Tube pitch(a)	in.(mm)	7/8×3/4(22×19)	7/8×3/4(22×19)	7/8×3/4(22×19)

	xrow pitch(b)				
	Fin spacing	in.(mm)	1/16(1.6)	1/16(1.6)	1/16(1.6)
	Fin type	Hydrophilic aluminum			
	Tube outside diameter	in.(mm)	Φ5/16(Φ7.94)	Φ5/16(Φ7.94)	Φ5/16(Φ7.94)
	Tube type	Inner-grooved			
Outdoor air flow		m <sup>3</sup> /h	64,000	64,000	64,000
		CFM	37,640	37,640	37,640
Sound pressure level		dB(A)	70	70	70
Connectable indoor unit	Total capacity	%	50-130	50-130	50-130
	Max. quantity	64		64	64
Outdoor unit	Dimension (W×H×D)	inch	52-3/4×64-3/8×31-1/8+ (52-3/4×64-3/8×31-1/8)×3	52-3/4×64-3/8×31-1/8+ (52-3/4×64-3/8×31-1/8)×3	(52-3/4×64-3/8×31-1/8)×4
		mm	1340×1635×790+ (1340×1635×790)×3	1340×1635×790+ (1340×1635×790)×3	(1340×1635×790)×4
	Packing (W×H×D)	inch	55-3/8×71-1/16×33-5/8+ (55-3/8×71-1/16×33-5/8)×3	55-3/8×71-1/16×33-5/8+ (55-3/8×71-1/16×33-5/8)×3	(55-3/8×71-1/16×33-5/8)×4
		mm	1405×1805×855+ (1405×1805×855)×3	1405×1805×855+ (1405×1805×855)×3	(1405×1805×855)×4
	Net weight	lbs.(kg)	673+750×3(305+340×3)	750+750×3(340+340×3)	750×4(340×4)
	Gross weight	lbs.(kg)	712+790×3(323+358×3)	790+790×3(358+358×3)	790×4(358×4)
Refrigerant	Type	R410A			
	Factory charged	lbs.(kg)	29+35×3(13+16×3)	35+35×3(16+16×3)	35×4(16×4)
Throttle type		EXV			
Design pressure(High/low)		MPa	4.4/2.6	4.4/2.6	4.4/2.6
		psi	640/380	640/380	640/380
Pipe connections	Liquid pipe	in.(mm)	Φ1(Φ25.4)	Φ1(Φ25.4)	Φ1(Φ25.4)
	Gas pipe	in.(mm)	Φ1-3/4(Φ44.5)	Φ1-3/4(Φ44.5)	Φ1-3/4(Φ44.5)
	Oil balance pipe	in.(mm)	Φ5/16(Φ8)	Φ5/16(Φ8)	Φ5/16(Φ8)
Operating temperature range	Cooling	°F(°C)	23~118.4(-5~48)		
	Heating	°F(°C)	-4~75.2(-20~24)		

## Notes:

Capacities are based on the following conditions:

Cooling: Indoor temperature 27°C(80.6°F) DB/19°C(66.2°F) WB; Outdoor temperature 35°C(95°F) DB/24°C(75.2°F) WB.

Heating: Indoor temperature 20°C(68°F) DB/15°C(59°F) WB; Outdoor temperature 7°C(44.6°F) DB/6°C(42.8°F) WB.

Piping length: Interconnecting piping length is 7.5m (24.6ft), level difference is zero.

Connection piping diameter is based on the condition that the total equivalent liquid length is less than 90m (295.2ft). When the total equivalent liquid length is more than 90m (295.2ft), please refer to technical manual to choose the connection piping diameter.

Sound values are measured in a semi-anechoic room, at a position 1m (3.28ft) in front of the unit and 1.3m (4.26ft) above the floor.

## 2. Dimensions

### 2.1 Overall dimensions

8, 10, 12HP, unit: mm (in.)

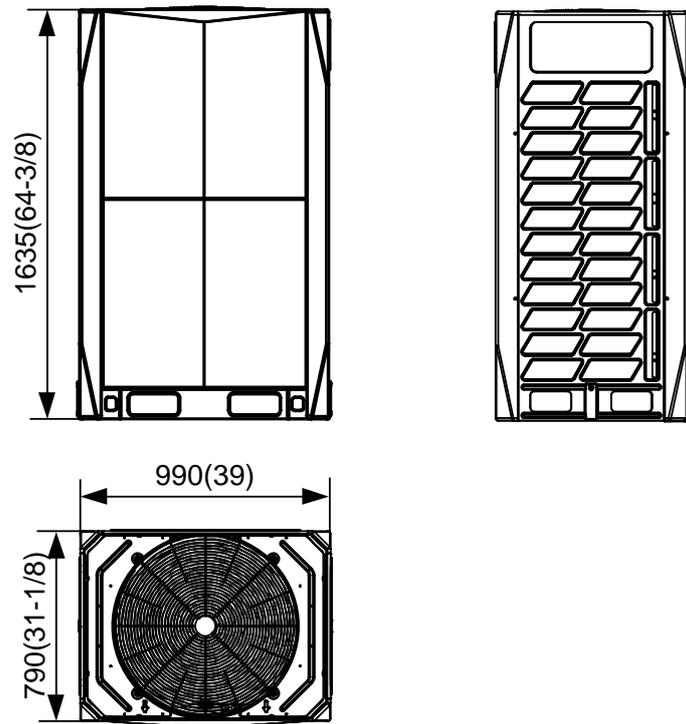

14, 16, 18, 20, 22HP, unit: mm (in.)

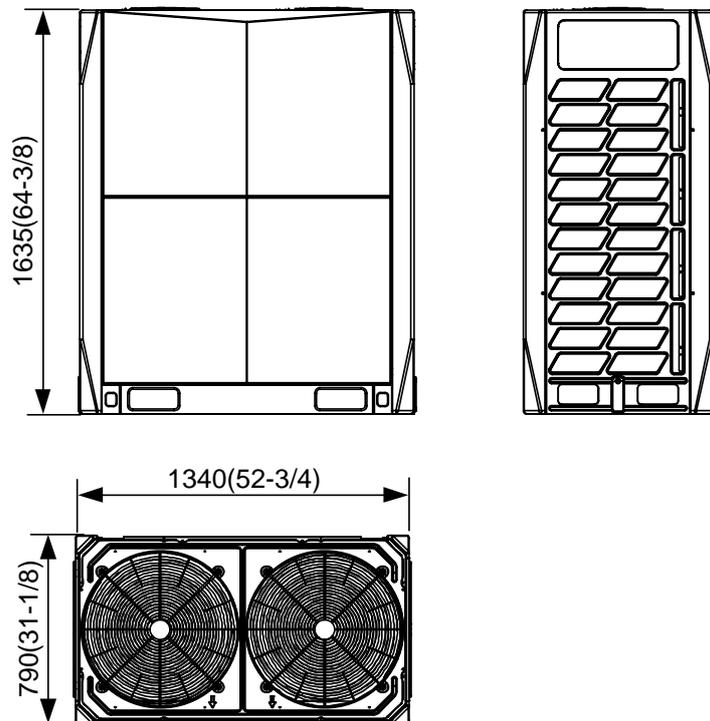

**2.2 Section dimensions**

Unit: in.(mm)

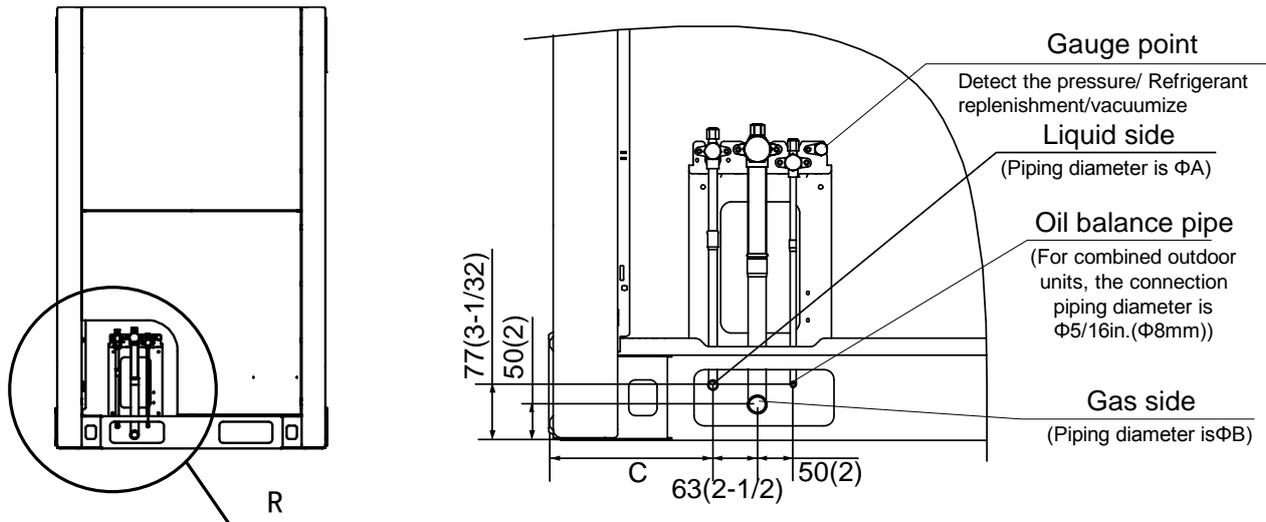

Specifications (Unit: in.(mm))

Size \ HP	8/10	12	14/16	18/20/22
A	Φ1/2(12.7)	Φ5/8(15.9)	Φ5/8(15.9)	Φ3/4(19.1)
B	Φ1(25.4)	Φ1-1/8(28.6)	Φ1-1/4(31.8)	Φ1-1/4(31.8)
C	9(229)	9(229)	9-5/8(244)	9-5/8(244)

### 3. Service space

Ensure enough space for maintenance. The modules in the same system must be on the same height.

- When installing the unit, leave enough space for maintenance.

Unit: mm (in.)

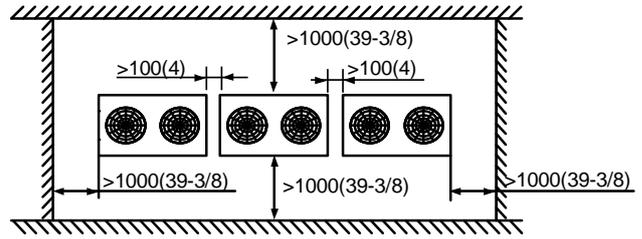
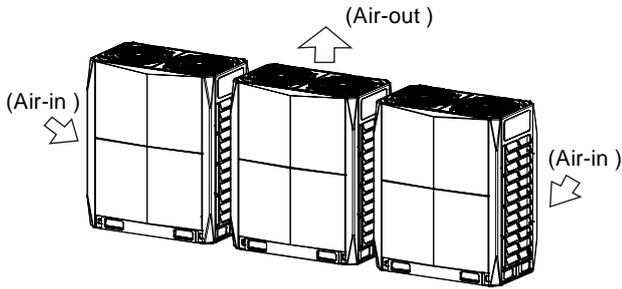

Top view of the outdoor unit

Installation and maintenance surface

- When the outdoor unit is higher than the surrounding obstacle

Unit: mm (in.)

#### One row

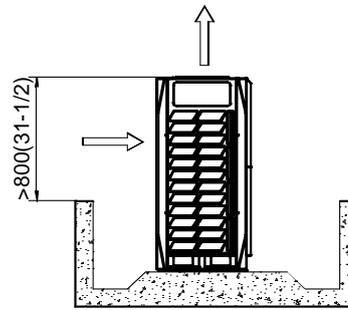
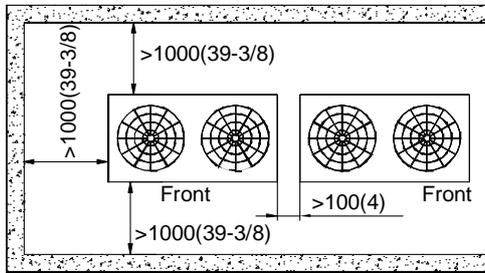

#### Two rows

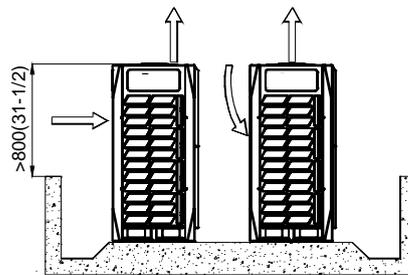
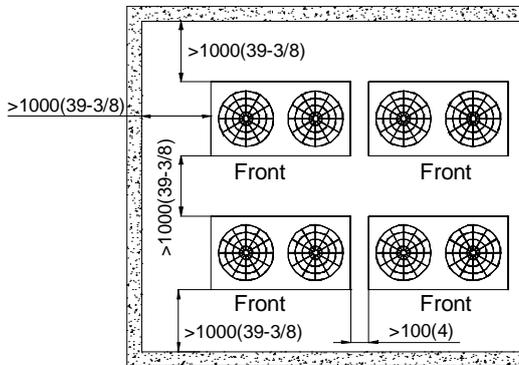

#### More than two rows

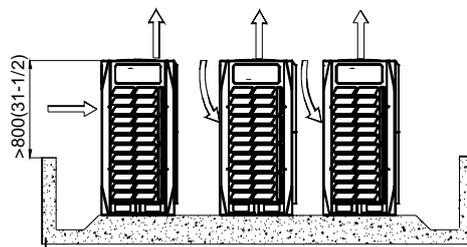
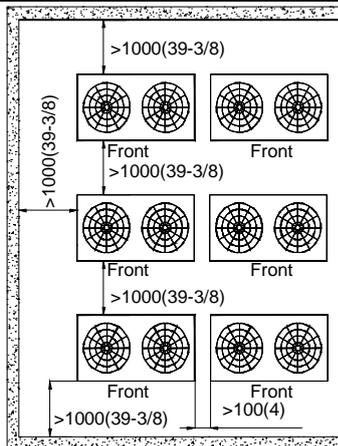

- When the outdoor unit is lower than the surrounding obstacle, to avoid cross connection of the outdoor hot air from affecting the heat exchange effect, please add an air director onto the exhaust hood of the outdoor unit to facilitate heat dissipation. See the figure below. The height of the air director is HD (namely H-h). Please make the air director on site.

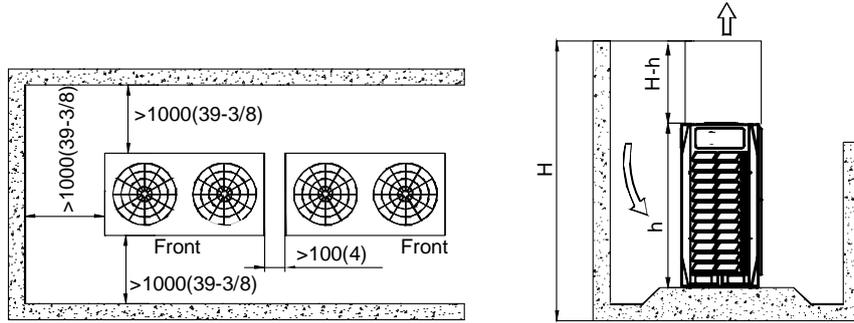

- If miscellaneous articles are piled around the outdoor unit, such articles must be 800mm (31-1/2in) below the top of the outdoor unit. The articles must be 800mm (31-1/2in) below the top of the outdoor unit. Otherwise, a mechanic exhaust device must be added.

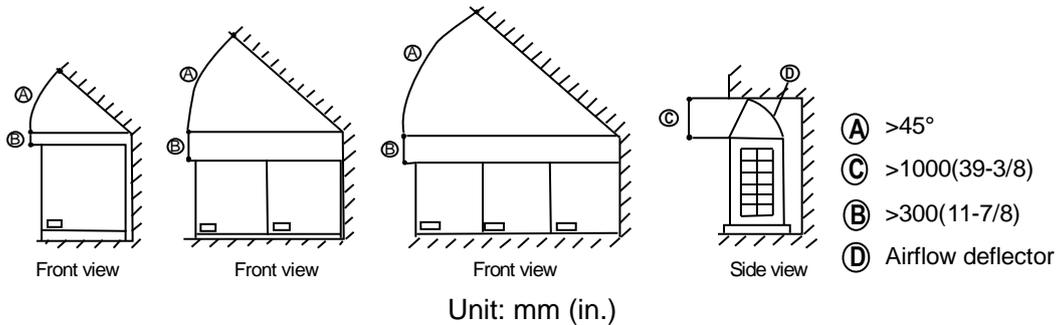

### 4. Piping diagrams

8, 10, 12HP

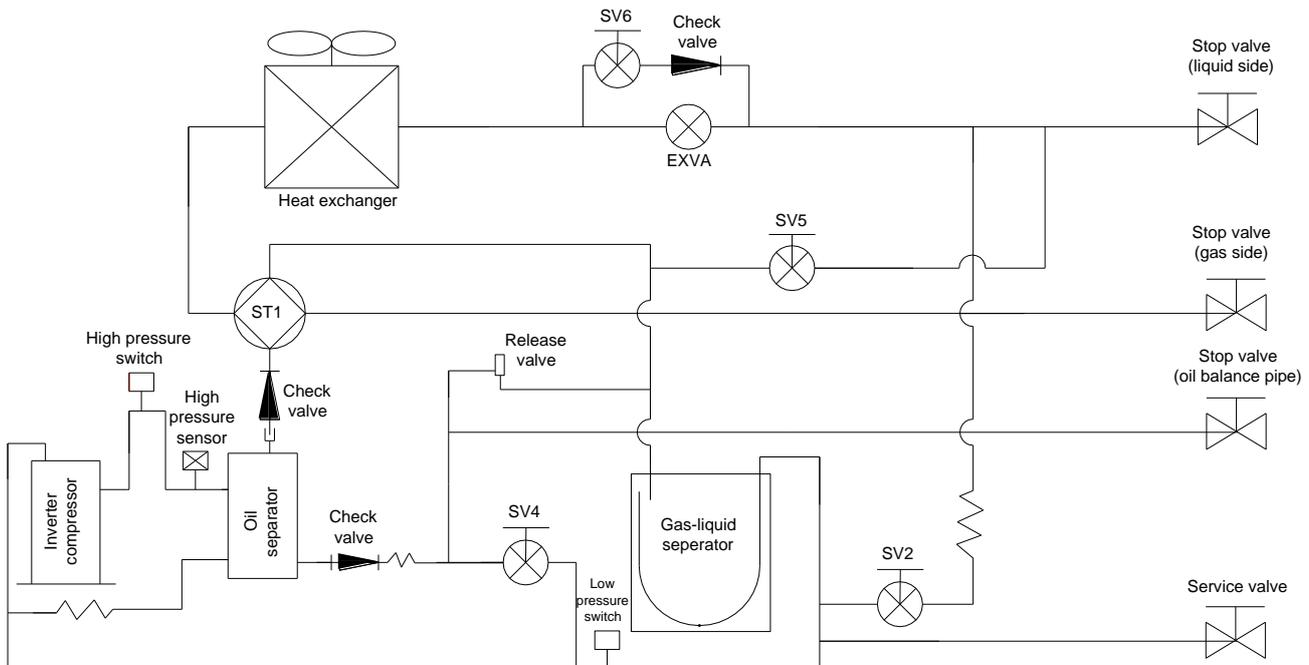

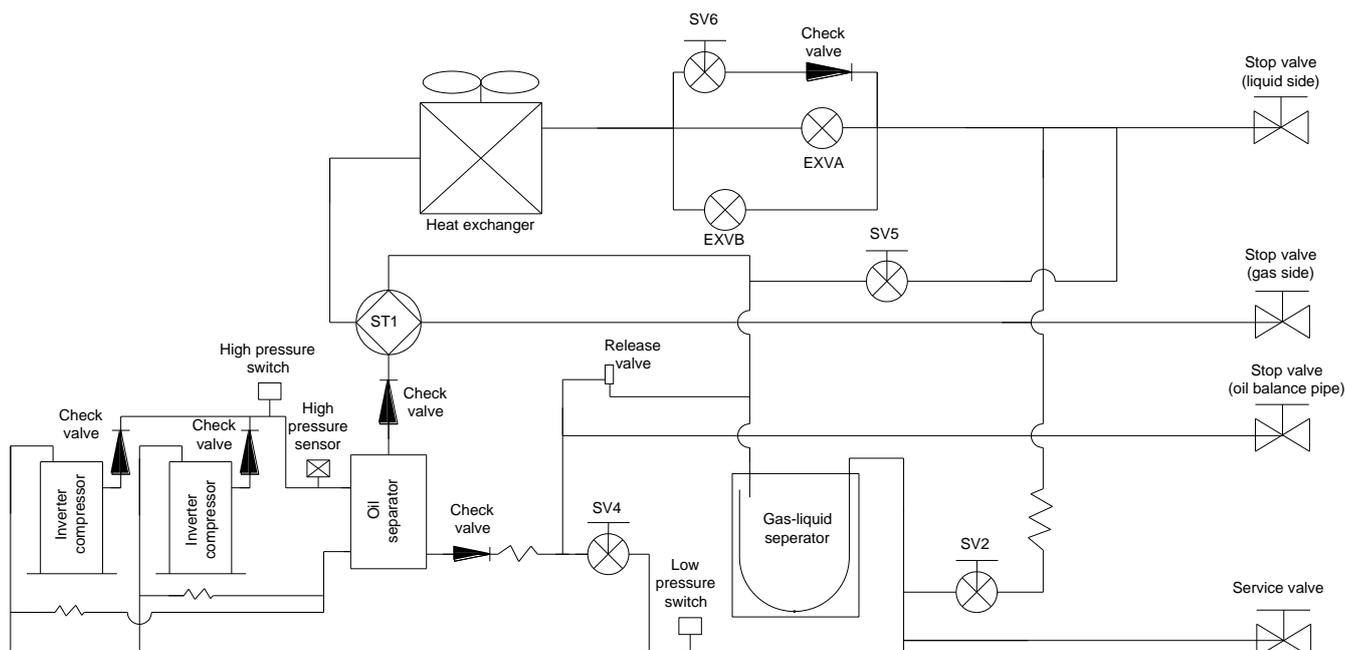

## 14, 16, 18, 20, 22HP

**Key components:**

**Oil separator:** It is used to separate oil from high pressure and high temperature gas refrigerant, which is pumped out from compressor. The separation efficiency is up to 99%, it makes the oil return back to each compressor very soon.

**Gas-liquid separator:** It is used to store the liquid refrigerant and oil; it can protect the compressor from liquid hammer.

**EXV (Electronic Expansion Valve):** It is used to adjust refrigerant volume.

**Four-way valve ST1:** closed in cooling mode and open in heating mode. It is used to change the refrigerant flow direction in heating mode. When the ST1 is OFF, the heat exchanger is condenser. When the ST1 is ON, the heat exchanger is evaporator.

**SV2:** It is used to protect compressor. When any compressor discharge temperature is higher than 100°C, SV2 will be open to spray a little liquid refrigerant to cooling compressor, and it will be closed when the discharge temperature is lower than 90°C.

**SV4:** oil return valve. It will open after the inverter compressor has been run for 5 minutes and will close 15 minutes later (for the system has only one outdoor unit.).

Every 20 minutes, SV4 of each outdoor unit will open for 3 minutes (for the system has more than one outdoor unit.).

**SV5:** It is used for fast defrosting. In defrosting mode, the opening of SV5 can shorten the refrigerant flowing circle, so the defrosting process will takes less time. In cooling mode, it is always off.

**SV6:** It is used for by-pass. Open when the discharge temperature is over-high in cooling mode, and close when the unit is standby or system is in heating mode.

**Pressure switch:** It is used to protect the system pressure. When the system pressure is too high or too low, the pressure switch will open. Once the pressure switch is open, the compressor will stop, and the compressor will restart after ten minutes.

## 5. Wiring diagram and field wiring

### 5.1 Wiring diagram

8, 10, 12HP

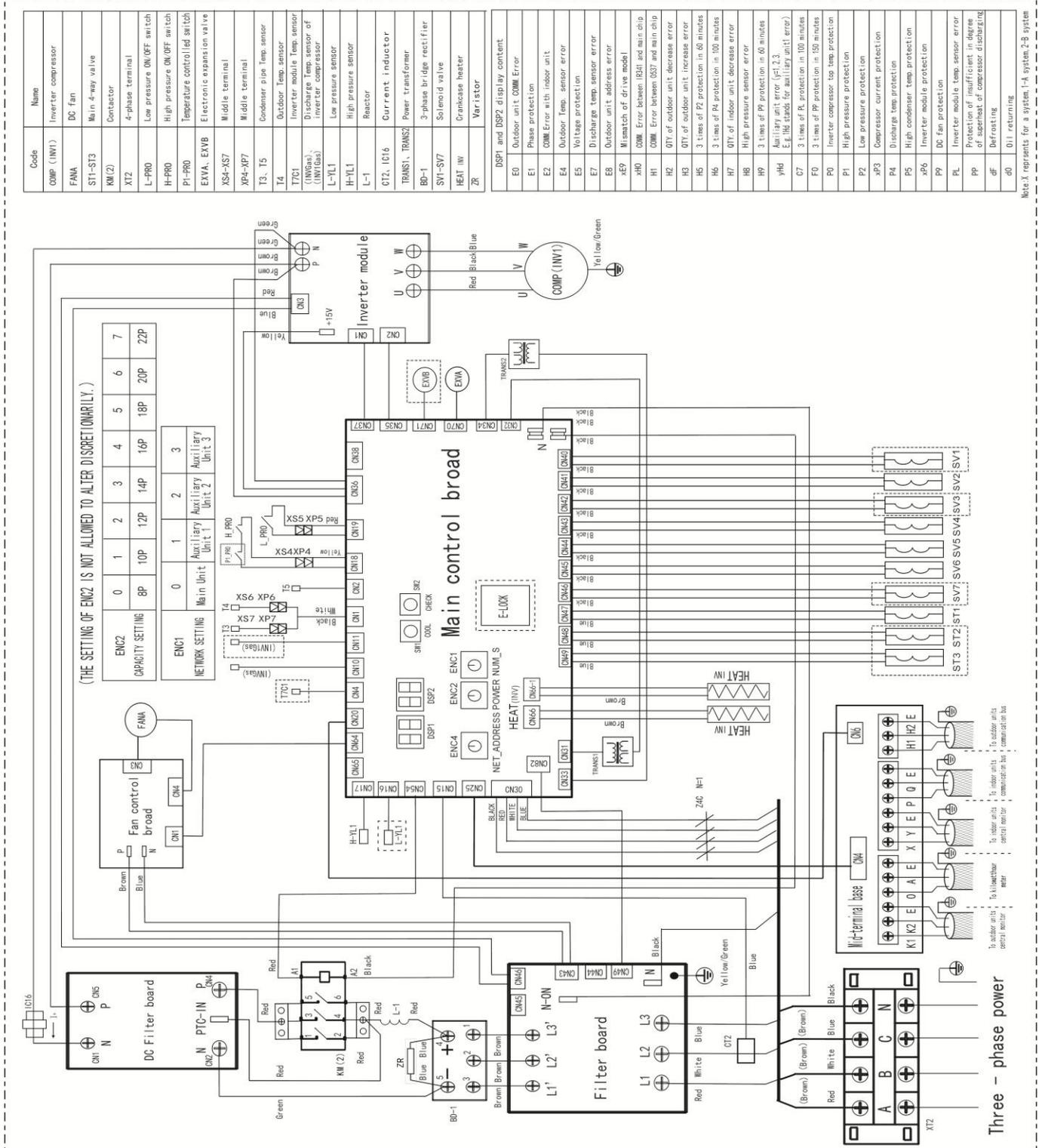

14, 16, 18, 20, 22HP

CODE	NAME
COMP (INV)	Inverter compressor
FANA, FANB	DC fan
ST1-ST3	Main 4-way valve
KM(1, 2)	Contact
XT2	4-phase terminal
L-PRO	Low pressure ON/OFF switch
H-PRO	High pressure ON/OFF switch
P1-PRO, P2-PRO	Temperature controlled switch
EXVA, EXVB	Electronic expansion valve
XS4-XS7	Middle terminal
XP4-XP7	Middle terminal
T3, T5	Condenser Pipe Temp sensor
T4	Outdoor Temp sensor
T7C1	Inverter module Temp sensor
(NWS4)	Discharge Temp sensor
(NWS3)	of inverter compressor
L-IL1	Low pressure sensor
H-IL1	High pressure sensor
L-1, L-2	Reactor
CT1, CT2, CT3	Current indicator
IC16, IC17	Power transformer
TRANS1, TRANS2	3-phase bridge rectifier
BD-1, BD-2	Solenoid valve
SV1-SV7	Crankcase heater
HEAT INV, HEAT INV1	Varistor
ZK, ZR1	DSF1 and DSF2 display content
E0	Outdoor unit COMM Error
E1	Phase protection
E2	COMM Error with indoor unit
E4	Outdoor Temp. sensor error
E5	Voltage protection
E7	Discharge temp sensor error
E8	Outdoor unit address error
xP	W switch of drive mode
xH0	COMM Error between IR24 and main chip
H1	COMM Error between 057 and main chip
H2	OTY of outdoor unit decrease error
H3	OTY of outdoor unit increase error
H5	3 times of P2 protection in 60 minutes
H6	3 times of P4 protection in 100 minutes
H7	OTY of indoor unit decrease error
H8	High pressure sensor error
H9	3 times of PP protection in 60 minutes
yH6	Auxiliary unit error (yH2, 3)
E7	E7, H6 stands for auxiliary unit error
E7	3 times of RL protection in 100 minutes
P0	3 times of PP protection in 150 minutes
P1	Inverter compressor top temp protection
P2	High pressure protection
xP3	Compressor current protection
P4	Discharge temp protection
P5	High condenser temp protection
xP6	Inverter module protection
P9	DC fan protection
PL	Inverter module temp sensor error
PP	Protection of insufficient in degree of superheat of compressor discharge gas
dF	Defrosting
d0	0:IT returning

Note: X represents for a system, 1-A system, 1-B system, 2-B system

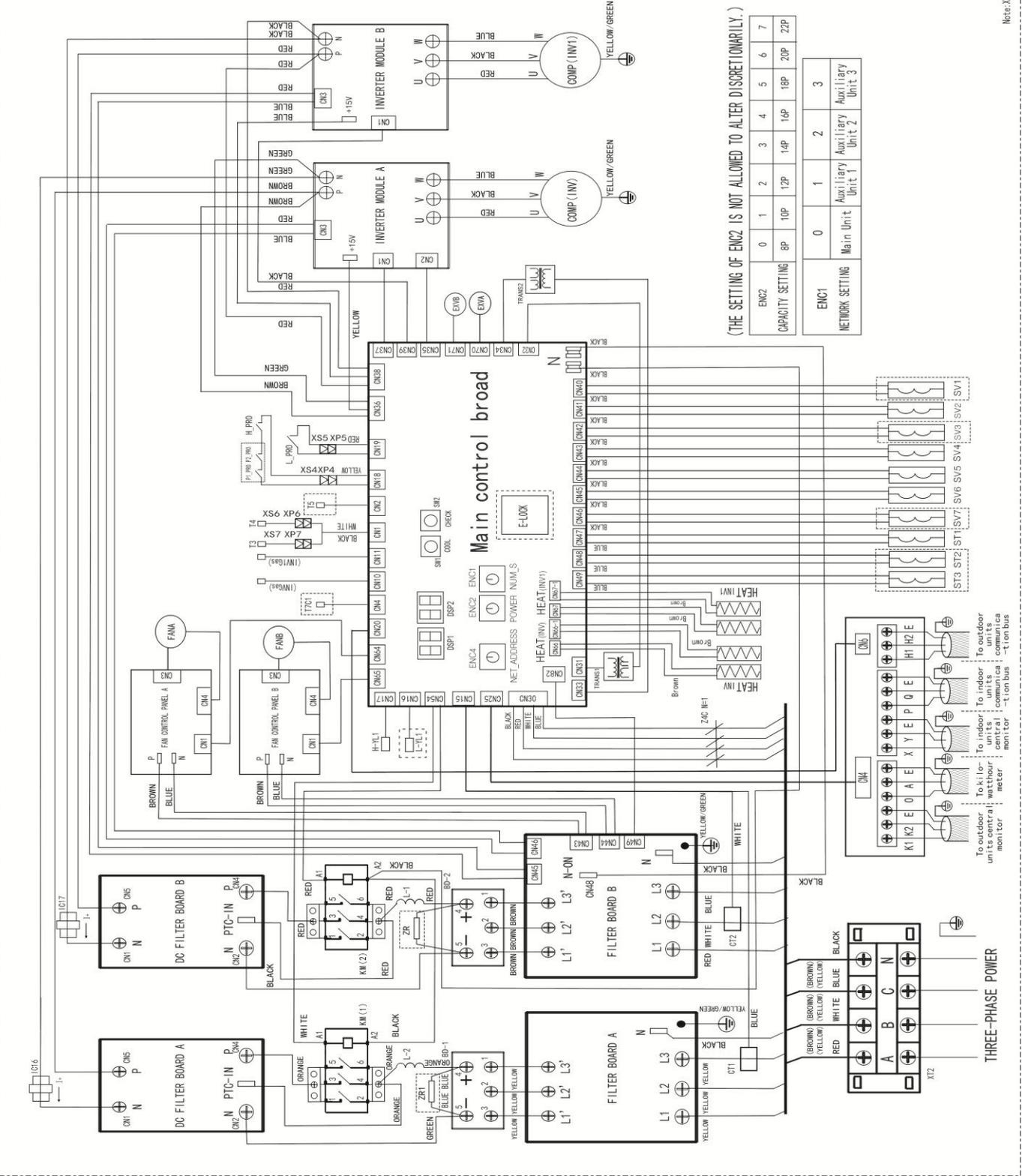

## 5.2 Field wiring

### 5.2.1 Signal wire between outdoor unit and indoor unit

Signal wire of indoor/outdoor unit adopts 3-core shielded wire ( $\geq 0.0012\text{in.}^2(0.75\text{mm}^2)$ ) which has polarity, please connect it correctly.

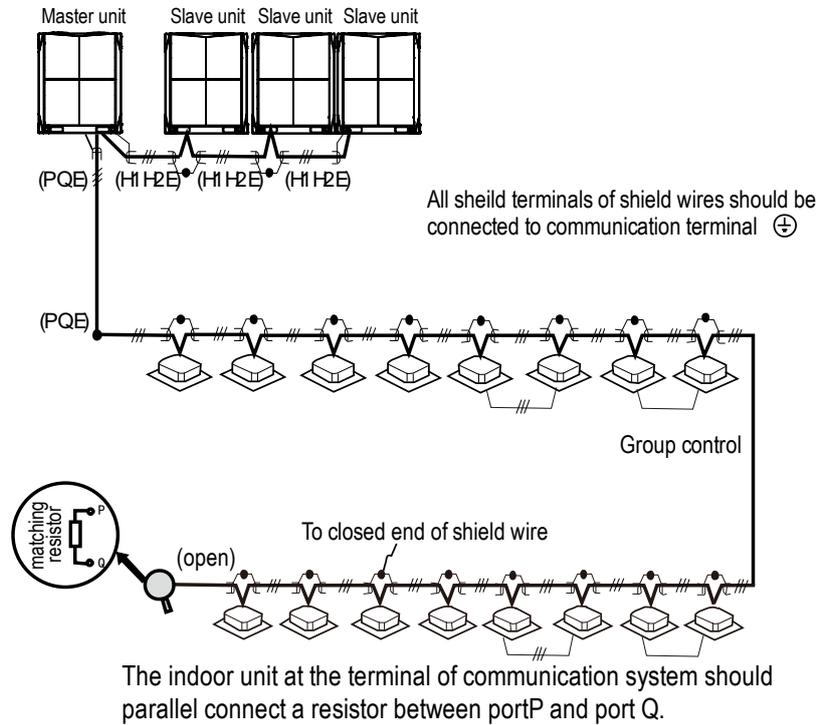

### 5.2.2 Example wiring connection

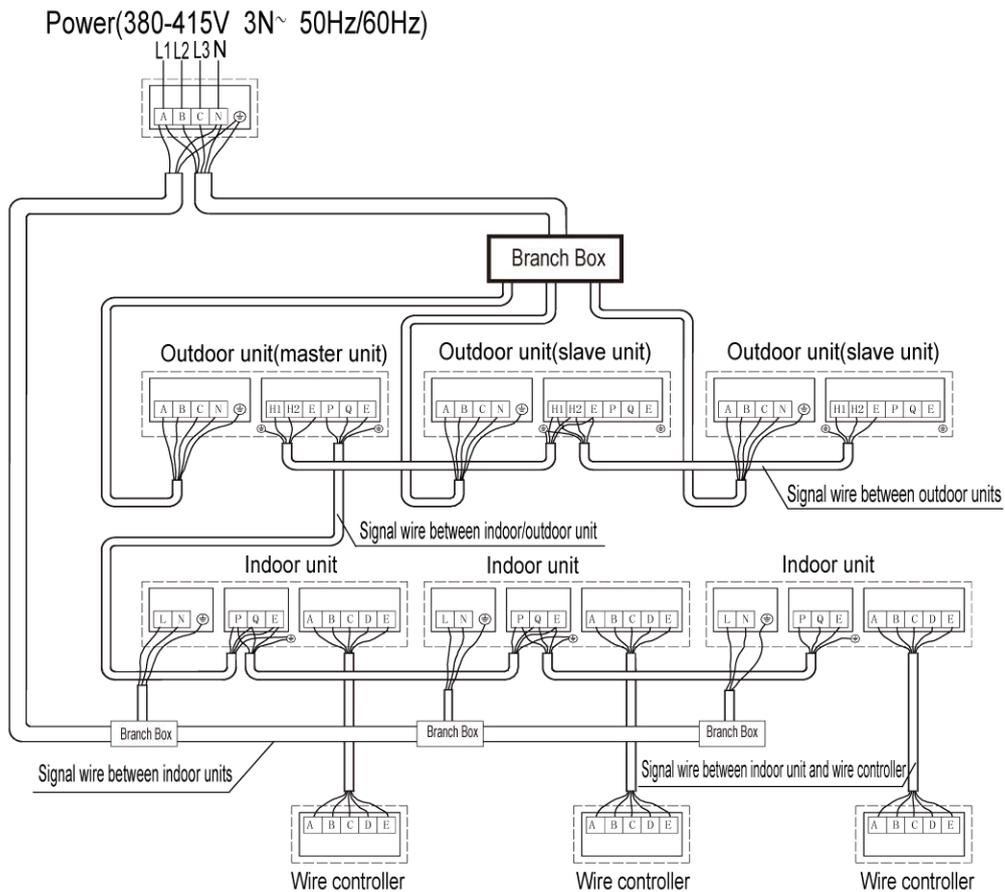

## 6. Electric characteristics

Model	Units				Power supply			Compressor		OFM	
	Hz	Voltage (V)	Min. (V)	Max. (V)	MCA (A)	TOCA (A)	MFA (A)	MSC (A)	RLA (A)	kW	FLA (A)
MVD-V5X252W/V2GN1	50/60	380~415	342	440	17.8	22.8	25	-	14.58	0.465	4.6
MVD-V5X280W/V2GN1	50/60	380~415	342	440	20.3	22.8	25	-	14.58	0.465	4.6
MVD-V5X335W/V2GN1	50/60	380~415	342	440	21.9	23.7	25	-	15.62	0.465	4.5
MVD-V5X400W/V2GN1	50/60	380~415	342	440	29	29.8	35	-	10.23+10.23	0.29+0.23	2.8+2.4
MVD-V5X450W/V2GN1	50/60	380~415	342	440	30.1	29.8	35	-	10.23+10.23	0.29+0.23	2.8+2.4
MVD-V5X500W/V2GN1	50/60	380~415	342	440	36.3	37.9	40	-	15.62+9.36	0.42+0.35	3.9+3.5
MVD-V5X560W/V2GN1	50/60	380~415	342	440	42.8	48.3	50	-	15.62+15.62	0.44+0.35	4.0+3.4
MVD-V5X615W/V2GN1	50/60	380~415	342	440	46.4	48.3	50	-	15.62+15.62	0.44+0.35	4.0+3.4

### Notes:

1. The current value of combination unit is the total value of each basic model:

For example: 46HP=22HP+12HP+12HP

Power current: MCA=46.4+21.9+21.9=90.2

TOCA=48.3+23.7+23.7=95.7

MFA=50+25+25=100

Compressor: RLA=15.62+15.62+15.62+15.62=62.48

OFM: FLA=4.0+3.4+4.5+4.5=16.4

2. RLA is based on the following conditions, Indoor temp. 27°C DB/19°C WB, Outdoor temp. 35°C DB

3. TOCA means the total value of each OC set.

4. MSC means the Max. current during the starting of compressor.

5. Voltage range units are suitable for use on electrical systems where voltage supplied to unit terminals is not below or above listed range limits.

6. Maximum allowable voltage variation between phase is 2%

7. Selection wire size based on the larger value of MCA or TOCA

8. MFA is used to select the circuit breaker and the ground fault circuit interrupter (earth circuit breaker).

**MCA:** Min. Circuit Amps. (A)

**TOCA:** Total Over-current Amps. (A)

**MFA:** Max. Fuse Amps. (A)

**MSC:** Max. Starting Amps. (A)

**RLA:** Rated Load Amps. (A)

**OFM:** Outdoor Fan Motor.

**FLA:** Full Load Amps. (A)

**KW:** Rated Motor Output (KW)

## 7. Capacity tables

### 7.1 Cooling capacity tables

#### MVD-V5X252W/V2GN1

TC: Total Capacity (kW); PI: Power Input (kW) (Compressor + Outdoor fan motor)

Combination (%)	Outdoor temperature (°C(°F) DB)	Indoor temperature(°C(°F))													
		DB:20.8(69.4) WB:14(57.2)		DB:23.3(73.9) WB:16(60.8)		DB:25.8(78.4) WB:18(64.4)		DB:27(80.6) WB:19(66.2)		DB:28.2(82.8) WB:20(68)		DB:30.7(87.3) WB:22(71.6)		DB:32(89.6) WB:24(75.2)	
		TC	PI	TC	PI	TC	PI	TC	PI	TC	PI	TC	PI	TC	PI
		kW	kW	kW	kW	kW	kW	kW	kW	kW	kW	kW	kW	kW	kW
130%	-5(23)	22.14	2.37	26.37	2.89	30.60	3.10	31.77	3.22	33.30	3.31	34.11	3.60	34.97	3.63
	-2(28.4)	22.14	2.37	26.37	2.94	30.60	3.10	31.77	3.24	33.30	3.31	34.11	3.65	34.97	3.66
	0(32)	22.14	2.41	26.37	3.00	30.60	3.21	31.77	3.42	33.30	3.51	34.11	3.69	34.97	3.71
	2(35.6)	22.14	2.45	26.37	3.00	30.60	3.32	31.77	3.61	33.30	3.55	34.11	3.72	34.97	3.77
	4(39.2)	22.14	2.51	26.37	3.06	30.60	3.43	31.77	3.63	33.30	3.59	34.11	3.72	34.97	3.84
	6(42.8)	22.14	2.55	26.37	3.12	30.60	3.56	31.77	3.66	32.93	3.70	33.69	3.72	34.58	3.87
	8(46.4)	22.14	2.61	26.37	3.19	30.60	3.74	31.77	3.84	32.52	3.83	33.33	3.90	34.14	3.90
	10(50)	22.14	2.67	26.37	3.26	30.60	3.88	31.77	3.96	32.13	4.04	32.94	4.06	33.75	4.02
	12(53.6)	22.14	2.72	26.37	3.32	30.60	3.96	31.32	4.03	31.77	4.06	32.49	4.07	33.30	4.04
	14(57.2)	22.14	2.77	26.37	3.39	30.51	4.05	30.96	4.06	31.32	4.08	32.13	4.09	32.94	4.13
	16(60.8)	22.14	2.82	26.37	3.46	30.15	4.06	30.51	4.08	30.87	4.10	31.68	4.12	32.49	4.20
	18(64.4)	22.14	2.87	26.37	3.53	29.70	4.14	30.06	4.16	30.51	4.18	31.32	4.22	32.13	4.26
	20(68)	22.14	2.93	26.37	3.75	29.25	4.34	29.70	4.36	30.06	4.39	30.87	4.42	31.68	4.47
	21(69.8)	22.14	3.01	26.37	3.89	29.07	4.44	29.52	4.46	29.88	4.49	30.69	4.53	31.50	4.57
	23(73.4)	22.14	3.23	26.37	4.17	28.71	4.64	29.07	4.67	29.43	4.69	30.24	4.74	31.05	4.78
	25(77)	22.14	3.45	26.37	4.46	28.26	4.85	28.62	4.87	29.07	4.90	29.88	4.95	30.69	4.99
	27(80.6)	22.14	3.68	26.37	4.78	27.90	5.05	28.26	5.08	28.62	5.10	29.43	5.16	30.24	5.21
	29(84.2)	22.14	3.93	26.37	5.10	27.45	5.25	27.81	5.28	28.26	5.31	29.07	5.37	29.88	5.42
	31(87.8)	22.14	4.20	26.28	5.40	27.00	5.46	27.45	5.49	27.81	5.52	28.62	5.58	29.43	5.64
	33(91.4)	22.14	4.47	25.83	5.60	26.64	5.67	27.00	5.70	27.45	5.73	28.26	5.79	28.98	5.85
35(95)	22.14	4.77	25.38	5.81	26.19	5.88	26.64	5.91	27.00	5.94	27.81	6.01	28.62	6.07	
37(98.6)	22.14	5.07	25.02	6.02	25.83	6.09	26.19	6.12	26.64	6.16	27.36	6.23	28.17	6.30	
39(102.2)	22.14	5.40	24.57	6.08	25.38	6.29	25.83	6.33	26.19	6.37	27.00	6.44	27.81	6.52	
41(105.8)	22.14	5.68	24.32	6.14	25.11	6.35	25.56	6.39	25.92	6.43	26.73	6.45	26.74	6.58	
43(109.4)	22.14	5.83	24.14	6.17	24.98	6.37	25.43	6.42	25.66	6.44	26.25	6.46	26.42	6.59	
45(113)	22.14	6.12	23.99	6.23	24.71	6.43	25.16	6.46	25.28	6.47	25.53	6.49	25.91	6.71	
48(118.4)	22.14	6.55	23.91	6.32	24.31	6.55	24.76	6.49	24.96	6.53	24.85	6.52	25.31	7.04	
120%	-5(23)	20.43	2.29	24.30	2.77	28.26	3.27	30.24	3.57	31.68	3.72	32.40	3.84	33.12	3.94
	-2(28.4)	20.43	2.31	24.30	2.80	28.26	3.31	30.24	3.59	31.68	3.77	32.40	3.87	33.12	3.96
	0(32)	20.43	2.33	24.30	2.82	28.26	3.34	30.24	3.60	31.68	3.80	32.40	3.90	33.12	3.97
	2(35.6)	20.43	2.34	24.30	2.85	28.26	3.37	30.24	3.63	31.68	3.81	32.40	3.93	33.12	3.97
	4(39.2)	20.43	2.36	24.30	2.88	28.26	3.42	30.24	3.67	31.68	3.87	32.40	3.93	33.12	3.98
	6(42.8)	20.43	2.38	24.30	2.90	28.26	3.46	30.24	3.71	31.68	3.91	32.40	3.97	33.12	4.00
	8(46.4)	20.43	2.41	24.30	2.93	28.26	3.50	30.24	3.76	31.68	3.95	32.40	3.98	33.12	4.02
	10(50)	20.43	2.43	24.30	2.97	28.26	3.53	30.24	3.82	31.68	3.95	32.40	3.99	33.12	4.03
	12(53.6)	20.43	2.48	24.30	3.03	28.26	3.60	30.24	3.89	31.23	3.97	31.95	3.97	32.67	4.06
	14(57.2)	20.43	2.53	24.30	3.09	28.26	3.68	30.24	3.97	30.78	3.99	31.59	4.03	32.31	4.11
	16(60.8)	20.43	2.57	24.30	3.15	28.26	3.75	30.06	4.10	30.42	4.05	31.14	4.10	31.86	4.17
	18(64.4)	20.43	2.62	24.30	3.22	28.26	3.87	29.61	4.14	29.97	4.15	30.69	4.19	31.50	4.23
	20(68)	20.43	2.68	24.30	3.34	28.26	4.17	29.25	4.34	29.61	4.35	30.33	4.39	31.05	4.43
	21(69.8)	20.43	2.70	24.30	3.46	28.26	4.32	28.98	4.44	29.34	4.46	30.15	4.50	30.87	4.54
	23(73.4)	20.43	2.89	24.30	3.71	28.26	4.62	28.62	4.64	28.98	4.66	29.70	4.71	30.42	4.74
	25(77)	20.43	3.08	24.30	3.96	27.81	4.82	28.17	4.84	28.53	4.86	29.34	4.91	30.06	4.96
	27(80.6)	20.43	3.29	24.30	4.24	27.45	5.02	27.81	5.05	28.17	5.07	28.89	5.12	29.61	5.17
	29(84.2)	20.43	3.51	24.30	4.53	27.00	5.22	27.36	5.25	27.72	5.27	28.44	5.33	29.25	5.38
	31(87.8)	20.43	3.75	24.30	4.83	26.55	5.43	27.00	5.45	27.36	5.49	28.08	5.54	28.80	5.60
	33(91.4)	20.43	3.99	24.30	5.15	26.19	5.63	26.55	5.67	26.91	5.69	27.63	5.75	28.35	5.81
35(95)	20.43	4.25	24.30	5.49	25.74	5.84	26.10	5.87	26.55	5.90	27.27	5.96	27.99	6.02	
37(98.6)	20.43	4.52	24.30	5.85	25.38	6.05	25.74	6.08	26.10	6.11	26.82	6.17	27.54	6.24	
39(102.2)	20.43	4.81	24.21	6.18	24.93	6.25	25.29	6.29	25.65	6.32	26.46	6.39	27.18	6.45	
41(105.8)	20.43	4.94	24.01	6.22	24.73	6.29	25.09	6.33	25.45	6.36	26.26	6.41	26.40	6.50	
43(109.4)	20.43	5.01	23.89	6.27	24.54	6.33	24.90	6.36	25.26	6.39	25.81	6.43	25.99	6.63	
45(113)	20.43	5.07	23.76	6.33	24.30	6.39	24.64	6.42	25.04	6.44	25.29	6.45	25.73	6.78	
48(118.4)	20.43	5.16	23.55	6.42	23.99	6.47	24.25	6.50	24.76	6.56	24.89	6.57	25.39	6.86	

**Cooling capacity tables**

**MVD-V5X252W/V2GN1**

TC: Total Capacity (kW); PI: Power Input (kW) (Compressor + Outdoor fan motor)

Combination (%)	Outdoor temperature (°C(°F) DB)	Indoor temperature(°C(°F))													
		DB:20.8(69.4) WB:14(57.2)		DB:23.3(73.9) WB:16(60.8)		DB:25.8(78.4) WB:18(64.4)		DB:27(80.6) WB:19(66.2)		DB:28.2(82.8) WB:20(68)		DB:30.7(87.3) WB:22(71.6)		DB:32(89.6) WB:24(75.2)	
		TC	PI	TC	PI	TC	PI	TC	PI	TC	PI	TC	PI	TC	PI
		kW	kW	kW	kW	kW	kW	kW	kW	kW	kW	kW	kW	kW	kW
110%	-5(23)	18.72	2.00	22.32	2.49	25.92	2.97	27.72	3.18	29.52	3.42	31.77	3.56	32.49	3.67
	-2(28.4)	18.72	2.03	22.32	2.52	25.92	2.99	27.72	3.21	29.52	3.45	31.77	3.59	32.49	3.69
	0(32)	18.72	2.05	22.32	2.53	25.92	3.01	27.72	3.24	29.52	3.49	31.77	3.63	32.49	3.73
	2(35.6)	18.72	2.10	22.32	2.56	25.92	3.06	27.72	3.27	29.52	3.53	31.77	3.68	32.49	3.78
	4(39.2)	18.72	2.14	22.32	2.58	25.92	3.09	27.72	3.31	29.52	3.58	31.77	3.73	32.49	3.81
	6(42.8)	18.72	2.16	22.32	2.61	25.92	3.12	27.72	3.36	29.52	3.62	31.77	3.77	32.49	3.87
	8(46.4)	18.72	2.18	22.32	2.66	25.92	3.15	27.72	3.40	29.52	3.66	31.77	3.80	32.49	3.91
	10(50)	18.72	2.21	22.32	2.69	25.92	3.20	27.72	3.46	29.52	3.72	31.77	3.82	32.49	3.95
	12(53.6)	18.72	2.26	22.32	2.75	25.92	3.26	27.72	3.53	29.52	3.79	31.41	3.88	32.04	4.00
	14(57.2)	18.72	2.29	22.32	2.79	25.92	3.32	27.72	3.59	29.52	3.86	30.96	3.91	31.68	4.03
	16(60.8)	18.72	2.33	22.32	2.85	25.92	3.39	27.72	3.66	29.52	3.94	30.60	3.96	31.23	4.07
	18(64.4)	18.72	2.38	22.32	2.90	25.92	3.46	27.72	3.76	29.52	4.13	30.15	4.16	30.87	4.20
	20(68)	18.72	2.43	22.32	2.97	25.92	3.66	27.72	4.04	29.07	4.33	29.79	4.36	30.42	4.40
	21(69.8)	18.72	2.45	22.32	3.05	25.92	3.79	27.72	4.19	28.89	4.43	29.52	4.46	30.24	4.50
	23(73.4)	18.72	2.57	22.32	3.27	25.92	4.07	27.72	4.50	28.44	4.63	29.16	4.67	29.79	4.71
	25(77)	18.72	2.74	22.32	3.50	25.92	4.35	27.72	4.82	28.08	4.83	28.71	4.88	29.43	4.92
	27(80.6)	18.72	2.92	22.32	3.74	25.92	4.65	27.27	5.02	27.63	5.03	28.35	5.08	28.98	5.13
	29(84.2)	18.72	3.11	22.32	3.99	25.92	4.97	26.91	5.22	27.27	5.24	27.90	5.29	28.62	5.34
	31(87.8)	18.72	3.32	22.32	4.25	25.92	5.31	26.46	5.42	26.82	5.45	27.54	5.49	28.17	5.55
	33(91.4)	18.72	3.53	22.32	4.53	25.74	5.60	26.10	5.63	26.46	5.65	27.09	5.70	27.81	5.76
35(95)	18.72	3.75	22.32	4.83	25.29	5.80	25.65	5.83	26.01	5.86	26.64	5.92	27.36	5.97	
37(98.6)	18.72	4.00	22.32	5.14	24.93	6.01	25.29	6.03	25.56	6.06	26.28	6.13	26.91	6.18	
39(102.2)	18.72	4.24	22.32	5.48	24.48	6.21	24.84	6.24	25.20	6.27	25.83	6.34	26.55	6.40	
41(105.8)	18.72	4.29	22.32	5.52	24.29	6.26	24.65	6.29	25.01	6.32	25.50	6.38	25.75	6.44	
43(109.4)	18.72	4.33	22.32	5.59	24.10	6.30	24.46	6.33	24.82	6.36	25.28	6.40	25.36	6.57	
45(113)	18.72	4.47	22.32	5.62	23.85	6.36	24.20	6.41	24.60	6.42	25.02	6.58	25.12	6.73	
48(118.4)	18.72	4.58	22.32	5.71	23.51	6.44	23.81	6.51	24.32	6.55	24.61	6.83	24.80	7.08	
100%	-5(23)	17.01	1.82	20.25	2.19	23.58	2.61	25.20	2.79	26.82	3.03	30.15	3.45	31.86	3.60
	-2(28.4)	17.01	1.84	20.25	2.22	23.58	2.63	25.20	2.84	26.82	3.07	30.15	3.49	31.86	3.62
	0(32)	17.01	1.86	20.25	2.24	23.58	2.66	25.20	2.88	26.82	3.10	30.15	3.55	31.86	3.67
	2(35.6)	17.01	1.90	20.25	2.27	23.58	2.69	25.20	2.92	26.82	3.13	30.15	3.60	31.86	3.72
	4(39.2)	17.01	1.91	20.25	2.29	23.58	2.73	25.20	2.96	26.82	3.17	30.15	3.64	31.86	3.76
	6(42.8)	17.01	1.94	20.25	2.34	23.58	2.77	25.20	3.01	26.82	3.22	30.15	3.69	31.86	3.82
	8(46.4)	17.01	1.97	20.25	2.37	23.58	2.82	25.20	3.05	26.82	3.27	30.15	3.75	31.86	3.89
	10(50)	17.01	2.00	20.25	2.42	23.58	2.86	25.20	3.10	26.82	3.33	30.15	3.81	31.86	3.94
	12(53.6)	17.01	2.03	20.25	2.47	23.58	2.92	25.20	3.15	26.82	3.39	30.15	3.88	31.41	3.97
	14(57.2)	17.01	2.07	20.25	2.51	23.58	2.97	25.20	3.22	26.82	3.46	30.15	3.96	31.05	4.02
	16(60.8)	17.01	2.11	20.25	2.56	23.58	3.04	25.20	3.28	26.82	3.53	29.97	4.00	30.60	4.07
	18(64.4)	17.01	2.15	20.25	2.61	23.58	3.09	25.20	3.34	26.82	3.60	29.61	4.14	30.24	4.17
	20(68)	17.01	2.19	20.25	2.66	23.58	3.18	25.20	3.51	26.82	3.85	29.16	4.33	29.79	4.37
	21(69.8)	17.01	2.21	20.25	2.68	23.58	3.30	25.20	3.64	26.82	3.99	28.98	4.43	29.61	4.47
	23(73.4)	17.01	2.26	20.25	2.86	23.58	3.53	25.20	3.89	26.82	4.28	28.62	4.63	29.16	4.67
	25(77)	17.01	2.41	20.25	3.06	23.58	3.78	25.20	4.17	26.82	4.58	28.17	4.84	28.80	4.88
	27(80.6)	17.01	2.57	20.25	3.26	23.58	4.04	25.20	4.46	26.82	4.90	27.72	5.04	28.35	5.09
	29(84.2)	17.01	2.74	20.25	3.48	23.58	4.32	25.20	4.77	26.73	5.20	27.36	5.25	27.99	5.29
	31(87.8)	17.01	2.92	20.25	3.71	23.58	4.60	25.20	5.09	26.37	5.41	26.91	5.45	27.54	5.50
	33(91.4)	17.01	3.10	20.25	3.96	23.58	4.91	25.20	5.43	25.92	5.61	26.55	5.66	27.18	5.71
35(95)	17.01	3.29	20.25	4.21	23.58	5.24	25.20	5.79	25.47	5.81	26.10	5.87	26.73	5.92	
37(98.6)	17.01	3.50	20.25	4.48	23.58	5.58	24.75	5.99	25.11	6.02	25.74	6.08	26.28	6.13	
39(102.2)	17.01	3.72	20.25	4.76	23.58	5.94	24.39	6.20	24.66	6.23	25.29	6.28	25.92	6.34	
41(105.8)	17.01	3.90	20.25	4.93	23.58	6.16	24.01	6.24	24.47	6.32	25.00	6.43	25.54	6.47	
43(109.4)	17.01	4.07	20.25	5.11	23.58	6.27	23.63	6.31	24.29	6.38	24.85	6.47	25.09	6.55	
45(113)	17.01	4.30	20.25	5.34	23.58	6.38	23.61	6.40	24.17	6.50	24.59	6.57	24.79	6.63	
48(118.4)	17.01	4.65	20.25	5.69	23.58	6.49	23.59	6.57	24.13	6.74	24.39	6.76	24.64	6.81	

**Cooling capacity tables**

**MVD-V5X252W/V2GN1**

**TC:** Total Capacity (kW); **PI:** Power Input (kW) (Compressor + Outdoor fan motor)

Combination (%)	Outdoor temperature (°C(°F) DB)	Indoor temperature(°C(°F))													
		DB:20.8(69.4)		DB:23.3(73.9)		DB:25.8(78.4)		DB:27(80.6)		DB:28.2(82.8)		DB:30.7(87.3)		DB:32(89.6)	
		WB:14(57.2)		WB:16(60.8)		WB:18(64.4)		WB:19(66.2)		WB:20(68)		WB:22(71.6)		WB:24(75.2)	
		TC	PI	TC	PI	TC	PI	TC	PI	TC	PI	TC	PI	TC	PI
		kW	kW	kW	kW	kW	kW	kW	kW	kW	kW	kW	kW	kW	
90%	-5(23)	15.30	1.61	18.27	1.93	21.24	2.28	22.68	2.48	24.12	2.64	27.09	3.04	30.06	3.48
	-2(28.4)	15.30	1.62	18.27	1.95	21.24	2.31	22.68	2.52	24.12	2.67	27.09	3.07	30.06	3.51
	0(32)	15.30	1.65	18.27	1.97	21.24	2.34	22.68	2.55	24.12	2.71	27.09	3.10	30.06	3.54
	2(35.6)	15.30	1.67	18.27	2.00	21.24	2.36	22.68	2.59	24.12	2.75	27.09	3.17	30.06	3.59
	4(39.2)	15.30	1.70	18.27	2.03	21.24	2.40	22.68	2.62	24.12	2.79	27.09	3.22	30.06	3.64
	6(42.8)	15.30	1.72	18.27	2.07	21.24	2.45	22.68	2.67	24.12	2.83	27.09	3.27	30.06	3.71
	8(46.4)	15.30	1.75	18.27	2.11	21.24	2.50	22.68	2.71	24.12	2.88	27.09	3.33	30.06	3.74
	10(50)	15.30	1.79	18.27	2.15	21.24	2.54	22.68	2.75	24.12	2.95	27.09	3.37	30.06	3.80
	12(53.6)	15.30	1.82	18.27	2.19	21.24	2.59	22.68	2.79	24.12	3.00	27.09	3.43	30.06	3.87
	14(57.2)	15.30	1.85	18.27	2.23	21.24	2.64	22.68	2.85	24.12	3.06	27.09	3.50	30.06	3.94
	16(60.8)	15.30	1.88	18.27	2.27	21.24	2.69	22.68	2.90	24.12	3.12	27.09	3.57	29.97	4.01
	18(64.4)	15.30	1.91	18.27	2.32	21.24	2.74	22.68	2.96	24.12	3.18	27.09	3.64	29.61	4.14
	20(68)	15.30	1.95	18.27	2.37	21.24	2.79	22.68	3.02	24.12	3.30	27.09	3.91	29.16	4.33
	21(69.8)	15.30	1.97	18.27	2.39	21.24	2.84	22.68	3.12	24.12	3.42	27.09	4.05	28.98	4.43
	23(73.4)	15.30	2.01	18.27	2.48	21.24	3.04	22.68	3.35	24.12	3.67	27.09	4.35	28.53	4.63
	25(77)	15.30	2.11	18.27	2.65	21.24	3.25	22.68	3.58	24.12	3.92	27.09	4.65	28.17	4.84
	27(80.6)	15.30	2.25	18.27	2.82	21.24	3.47	22.68	3.82	24.12	4.19	27.09	4.98	27.72	5.04
	29(84.2)	15.30	2.40	18.27	3.01	21.24	3.71	22.68	4.08	24.12	4.48	26.82	5.20	27.36	5.24
	31(87.8)	15.30	2.54	18.27	3.21	21.24	3.95	22.68	4.35	24.12	4.78	26.37	5.41	26.91	5.45
	33(91.4)	15.30	2.70	18.27	3.41	21.24	4.21	22.68	4.64	24.12	5.10	26.01	5.62	26.55	5.66
35(95)	15.30	2.87	18.27	3.63	21.24	4.49	22.68	4.95	24.12	5.43	25.56	5.82	26.10	5.87	
37(98.6)	15.30	3.04	18.27	3.85	21.24	4.78	22.68	5.27	24.12	5.79	25.11	6.02	25.74	6.07	
39(102.2)	15.30	3.23	18.27	4.10	21.24	5.08	22.68	5.61	24.12	6.16	24.75	6.23	25.29	6.28	
41(105.8)	15.30	3.34	18.27	4.29	21.24	5.27	22.68	5.76	24.12	6.20	24.58	6.39	25.12	6.43	
43(109.4)	15.30	3.50	18.27	4.48	21.24	5.45	22.68	5.91	24.12	6.33	24.45	6.48	24.90	6.53	
45(113)	15.30	3.73	18.27	4.70	21.24	5.67	22.68	6.11	24.12	6.51	24.32	6.54	24.52	6.62	
48(118.4)	15.30	4.02	18.27	4.99	21.24	5.97	22.68	6.40	24.12	6.66	24.22	6.68	24.34	6.73	
80%	-5(23)	13.59	1.42	16.20	1.68	18.81	1.98	20.16	2.11	21.51	2.27	24.12	2.63	26.73	3.00
	-2(28.4)	13.59	1.44	16.20	1.70	18.81	2.00	20.16	2.14	21.51	2.29	24.12	2.65	26.73	3.03
	0(32)	13.59	1.46	16.20	1.72	18.81	2.03	20.16	2.17	21.51	2.33	24.12	2.69	26.73	3.07
	2(35.6)	13.59	1.49	16.20	1.74	18.81	2.05	20.16	2.21	21.51	2.38	24.12	2.74	26.73	3.13
	4(39.2)	13.59	1.52	16.20	1.77	18.81	2.09	20.16	2.26	21.51	2.42	24.12	2.79	26.73	3.17
	6(42.8)	13.59	1.54	16.20	1.81	18.81	2.13	20.16	2.31	21.51	2.46	24.12	2.83	26.73	3.22
	8(46.4)	13.59	1.57	16.20	1.85	18.81	2.18	20.16	2.35	21.51	2.52	24.12	2.88	26.73	3.28
	10(50)	13.59	1.58	16.20	1.90	18.81	2.23	20.16	2.40	21.51	2.58	24.12	2.94	26.73	3.32
	12(53.6)	13.59	1.61	16.20	1.93	18.81	2.27	20.16	2.45	21.51	2.63	24.12	3.00	26.73	3.38
	14(57.2)	13.59	1.64	16.20	1.97	18.81	2.31	20.16	2.49	21.51	2.68	24.12	3.05	26.73	3.44
	16(60.8)	13.59	1.66	16.20	2.00	18.81	2.36	20.16	2.54	21.51	2.72	24.12	3.11	26.73	3.50
	18(64.4)	13.59	1.69	16.20	2.04	18.81	2.40	20.16	2.59	21.51	2.78	24.12	3.18	26.73	3.57
	20(68)	13.59	1.72	16.20	2.08	18.81	2.45	20.16	2.64	21.51	2.83	24.12	3.29	26.73	3.82
	21(69.8)	13.59	1.74	16.20	2.09	18.81	2.47	20.16	2.67	21.51	2.90	24.12	3.41	26.73	3.96
	23(73.4)	13.59	1.77	16.20	2.14	18.81	2.59	20.16	2.84	21.51	3.10	24.12	3.65	26.73	4.25
	25(77)	13.59	1.83	16.20	2.27	18.81	2.77	20.16	3.04	21.51	3.31	24.12	3.91	26.73	4.55
	27(80.6)	13.59	1.94	16.20	2.42	18.81	2.95	20.16	3.24	21.51	3.53	24.12	4.17	26.73	4.87
	29(84.2)	13.59	2.07	16.20	2.58	18.81	3.14	20.16	3.45	21.51	3.78	24.12	4.46	26.73	5.21
	31(87.8)	13.59	2.19	16.20	2.74	18.81	3.35	20.16	3.68	21.51	4.03	24.12	4.76	26.28	5.41
	33(91.4)	13.59	2.33	16.20	2.91	18.81	3.57	20.16	3.92	21.51	4.28	24.12	5.07	25.92	5.61
35(95)	13.59	2.47	16.20	3.10	18.81	3.79	20.16	4.17	21.51	4.57	24.12	5.41	25.47	5.81	
37(98.6)	13.59	2.62	16.20	3.28	18.81	4.03	20.16	4.44	21.51	4.86	24.12	5.77	25.11	6.02	
39(102.2)	13.59	2.78	16.20	3.50	18.81	4.29	20.16	4.72	21.51	5.17	24.12	6.14	24.66	6.23	
41(105.8)	13.59	2.84	16.20	3.53	18.81	4.35	20.16	4.85	21.51	5.27	24.12	6.30	24.51	6.34	
43(109.4)	13.59	2.92	16.20	3.57	18.81	4.42	20.16	4.93	21.51	5.34	24.12	6.37	24.36	6.40	
45(113)	13.59	3.01	16.20	3.61	18.81	4.50	20.16	5.03	21.51	5.43	24.12	6.44	24.05	6.51	
48(118.4)	13.59	3.07	16.20	3.67	18.81	4.63	20.16	5.22	21.51	5.59	24.12	6.59	23.85	6.73	



**Cooling capacity tables**

**MVD-V5X252W/V2GN1**

**TC:** Total Capacity (kW); **PI:** Power Input (kW) (Compressor + Outdoor fan motor)

Combination (%)	Outdoor temperature (°C(°F) DB)	Indoor temperature(°C(°F))													
		DB:20.8(69.4)		DB:23.3(73.9)		DB:25.8(78.4)		DB:27(80.6)		DB:28.2(82.8)		DB:30.7(87.3)		DB:32(89.6)	
		WB:14(57.2)		WB:16(60.8)		WB:18(64.4)		WB:19(66.2)		WB:20(68)		WB:22(71.6)		WB:24(75.2)	
		TC	PI	TC	PI	TC	PI	TC	PI	TC	PI	TC	PI	TC	PI
		kW	kW	kW	kW	kW	kW	kW	kW	kW	kW	kW	kW	kW	
70%	-5(23)	11.88	1.26	14.22	1.48	16.47	1.68	17.64	1.80	18.81	1.92	21.06	2.20	23.40	2.53
	-2(28.4)	11.88	1.28	14.22	1.49	16.47	1.69	17.64	1.84	18.81	1.96	21.06	2.23	23.40	2.56
	0(32)	11.88	1.28	14.22	1.51	16.47	1.73	17.64	1.87	18.81	1.99	21.06	2.28	23.40	2.60
	2(35.6)	11.88	1.29	14.22	1.52	16.47	1.75	17.64	1.91	18.81	2.03	21.06	2.33	23.40	2.64
	4(39.2)	11.88	1.31	14.22	1.56	16.47	1.79	17.64	1.94	18.81	2.07	21.06	2.37	23.40	2.70
	6(42.8)	11.88	1.33	14.22	1.58	16.47	1.84	17.64	2.00	18.81	2.12	21.06	2.41	23.40	2.75
	8(46.4)	11.88	1.35	14.22	1.63	16.47	1.88	17.64	2.03	18.81	2.17	21.06	2.48	23.40	2.81
	10(50)	11.88	1.38	14.22	1.65	16.47	1.93	17.64	2.08	18.81	2.22	21.06	2.53	23.40	2.84
	12(53.6)	11.88	1.41	14.22	1.68	16.47	1.97	17.64	2.11	18.81	2.26	21.06	2.57	23.40	2.90
	14(57.2)	11.88	1.44	14.22	1.71	16.47	2.00	17.64	2.15	18.81	2.30	21.06	2.62	23.40	2.95
	16(60.8)	11.88	1.46	14.22	1.74	16.47	2.04	17.64	2.19	18.81	2.35	21.06	2.67	23.40	3.00
	18(64.4)	11.88	1.48	14.22	1.77	16.47	2.08	17.64	2.23	18.81	2.39	21.06	2.72	23.40	3.07
	20(68)	11.88	1.51	14.22	1.80	16.47	2.11	17.64	2.27	18.81	2.43	21.06	2.78	23.40	3.15
	21(69.8)	11.88	1.52	14.22	1.82	16.47	2.13	17.64	2.29	18.81	2.46	21.06	2.82	23.40	3.26
	23(73.4)	11.88	1.54	14.22	1.85	16.47	2.18	17.64	2.37	18.81	2.58	21.06	3.02	23.40	3.50
	25(77)	11.88	1.58	14.22	1.93	16.47	2.32	17.64	2.54	18.81	2.75	21.06	3.23	23.40	3.74
	27(80.6)	11.88	1.67	14.22	2.05	16.47	2.47	17.64	2.70	18.81	2.94	21.06	3.45	23.40	4.00
	29(84.2)	11.88	1.77	14.22	2.18	16.47	2.63	17.64	2.88	18.81	3.13	21.06	3.68	23.40	4.27
	31(87.8)	11.88	1.87	14.22	2.31	16.47	2.80	17.64	3.06	18.81	3.33	21.06	3.92	23.40	4.55
	33(91.4)	11.88	1.99	14.22	2.46	16.47	2.98	17.64	3.25	18.81	3.55	21.06	4.18	23.40	4.85
35(95)	11.88	2.11	14.22	2.61	16.47	3.16	17.64	3.46	18.81	3.78	21.06	4.45	23.40	5.17	
37(98.6)	11.88	2.22	14.22	2.76	16.47	3.36	17.64	3.68	18.81	4.02	21.06	4.74	23.40	5.51	
39(102.2)	11.88	2.36	14.22	2.93	16.47	3.57	17.64	3.91	18.81	4.27	21.06	5.03	23.40	5.87	
41(105.8)	11.88	2.46	14.22	3.03	16.47	3.67	17.64	4.04	18.81	4.40	21.06	5.24	23.40	6.13	
43(109.4)	11.88	2.66	14.22	3.24	16.47	3.82	17.64	4.26	18.81	4.53	21.06	5.43	23.40	6.32	
45(113)	11.88	2.72	14.22	3.31	16.47	3.90	17.64	4.33	18.81	4.75	21.06	5.73	23.40	6.56	
48(118.4)	11.88	2.90	14.22	3.52	16.47	4.14	17.64	4.53	18.81	4.89	21.06	5.90	23.40	6.70	
60%	-5(23)	10.17	1.08	12.15	1.25	14.13	1.46	15.12	1.55	16.11	1.68	18.09	1.88	20.07	2.16
	-2(28.4)	10.17	1.08	12.15	1.27	14.13	1.48	15.12	1.58	16.11	1.69	18.09	1.91	20.07	2.17
	0(32)	10.17	1.10	12.15	1.29	14.13	1.50	15.12	1.60	16.11	1.72	18.09	1.94	20.07	2.20
	2(35.6)	10.17	1.12	12.15	1.32	14.13	1.53	15.12	1.63	16.11	1.75	18.09	1.98	20.07	2.23
	4(39.2)	10.17	1.15	12.15	1.34	14.13	1.56	15.12	1.65	16.11	1.77	18.09	2.01	20.07	2.26
	6(42.8)	10.17	1.16	12.15	1.37	14.13	1.59	15.12	1.68	16.11	1.81	18.09	2.05	20.07	2.32
	8(46.4)	10.17	1.19	12.15	1.39	14.13	1.62	15.12	1.71	16.11	1.84	18.09	2.09	20.07	2.35
	10(50)	10.17	1.21	12.15	1.42	14.13	1.65	15.12	1.76	16.11	1.88	18.09	2.13	20.07	2.39
	12(53.6)	10.17	1.23	12.15	1.44	14.13	1.68	15.12	1.79	16.11	1.91	18.09	2.17	20.07	2.43
	14(57.2)	10.17	1.25	12.15	1.47	14.13	1.70	15.12	1.83	16.11	1.95	18.09	2.21	20.07	2.47
	16(60.8)	10.17	1.26	12.15	1.49	14.13	1.73	15.12	1.86	16.11	1.98	18.09	2.25	20.07	2.52
	18(64.4)	10.17	1.29	12.15	1.51	14.13	1.76	15.12	1.89	16.11	2.02	18.09	2.29	20.07	2.57
	20(68)	10.17	1.30	12.15	1.54	14.13	1.79	15.12	1.93	16.11	2.06	18.09	2.33	20.07	2.62
	21(69.8)	10.17	1.32	12.15	1.55	14.13	1.81	15.12	1.94	16.11	2.08	18.09	2.36	20.07	2.65
	23(73.4)	10.17	1.33	12.15	1.58	14.13	1.84	15.12	1.98	16.11	2.11	18.09	2.45	20.07	2.82
	25(77)	10.17	1.36	12.15	1.61	14.13	1.91	15.12	2.08	16.11	2.25	18.09	2.61	20.07	3.00
	27(80.6)	10.17	1.41	12.15	1.71	14.13	2.04	15.12	2.22	16.11	2.40	18.09	2.79	20.07	3.21
	29(84.2)	10.17	1.49	12.15	1.81	14.13	2.17	15.12	2.36	16.11	2.55	18.09	2.97	20.07	3.43
	31(87.8)	10.17	1.58	12.15	1.92	14.13	2.30	15.12	2.50	16.11	2.72	18.09	3.16	20.07	3.64
	33(91.4)	10.17	1.67	12.15	2.04	14.13	2.44	15.12	2.66	16.11	2.89	18.09	3.36	20.07	3.89
35(95)	10.17	1.77	12.15	2.16	14.13	2.59	15.12	2.82	16.11	3.07	18.09	3.58	20.07	4.14	
37(98.6)	10.17	1.87	12.15	2.29	14.13	2.75	15.12	3.00	16.11	3.25	18.09	3.81	20.07	4.40	
39(102.2)	10.17	1.97	12.15	2.42	14.13	2.91	15.12	3.18	16.11	3.46	18.09	4.04	20.07	4.68	
41(105.8)	10.17	2.04	12.15	2.52	14.13	3.02	15.12	3.30	16.11	3.58	18.09	4.23	20.07	4.89	
43(109.4)	10.17	2.10	12.15	2.63	14.13	3.12	15.12	3.40	16.11	3.71	18.09	4.41	20.07	5.11	
45(113)	10.17	2.20	12.15	2.76	14.13	3.25	15.12	3.53	16.11	3.89	18.09	4.61	20.07	5.39	
48(118.4)	10.17	2.37	12.15	2.95	14.13	3.42	15.12	3.74	16.11	4.19	18.09	4.85	20.07	5.81	

**Cooling capacity tables****MVD-V5X252W/V2GN1**

**TC:** Total Capacity (kW); **PI:** Power Input (kW) (Compressor + Outdoor fan motor)

Combination (%)	Outdoor temperature (°C(°F) DB)	Indoor temperature(°C(°F))													
		DB:20.8(69.4) WB:14(57.2)		DB:23.3(73.9) WB:16(60.8)		DB:25.8(78.4) WB:18(64.4)		DB:27(80.6) WB:19(66.2)		DB:28.2(82.8) WB:20(68)		DB:30.7(87.3) WB:22(71.6)		DB:32(89.6) WB:24(75.2)	
		TC	PI	TC	PI	TC	PI	TC	PI	TC	PI	TC	PI	TC	PI
		kW	kW	kW	kW	kW	kW	kW	kW	kW	kW	kW	kW	kW	kW
50%	-5(23)	8.51	0.94	10.17	1.08	11.79	1.24	12.60	1.30	13.41	1.38	15.03	1.56	16.74	1.69
	-2(28.4)	8.51	0.94	10.17	1.11	11.79	1.26	12.60	1.32	13.41	1.40	15.03	1.58	16.74	1.71
	0(32)	8.51	0.96	10.17	1.12	11.79	1.28	12.60	1.34	13.41	1.42	15.03	1.61	16.74	1.74
	2(35.6)	8.51	0.97	10.17	1.14	11.79	1.30	12.60	1.36	13.41	1.44	15.03	1.62	16.74	1.77
	4(39.2)	8.51	0.98	10.17	1.16	11.79	1.32	12.60	1.38	13.41	1.47	15.03	1.66	16.74	1.82
	6(42.8)	8.51	1.00	10.17	1.18	11.79	1.34	12.60	1.41	13.41	1.50	15.03	1.68	16.74	1.87
	8(46.4)	8.51	1.02	10.17	1.20	11.79	1.36	12.60	1.44	13.41	1.52	15.03	1.71	16.74	1.93
	10(50)	8.51	1.05	10.17	1.21	11.79	1.38	12.60	1.46	13.41	1.56	15.03	1.76	16.74	1.96
	12(53.6)	8.51	1.05	10.17	1.22	11.79	1.40	12.60	1.49	13.41	1.59	15.03	1.79	16.74	1.99
	14(57.2)	8.51	1.07	10.17	1.24	11.79	1.42	12.60	1.52	13.41	1.62	15.03	1.82	16.74	2.03
	16(60.8)	8.51	1.08	10.17	1.26	11.79	1.44	12.60	1.54	13.41	1.64	15.03	1.85	16.74	2.06
	18(64.4)	8.51	1.10	10.17	1.28	11.79	1.47	12.60	1.57	13.41	1.67	15.03	1.88	16.74	2.10
	20(68)	8.51	1.12	10.17	1.30	11.79	1.49	12.60	1.59	13.41	1.70	15.03	1.91	16.74	2.14
	21(69.8)	8.51	1.12	10.17	1.31	11.79	1.51	12.60	1.61	13.41	1.72	15.03	1.93	16.74	2.16
	23(73.4)	8.51	1.14	10.17	1.33	11.79	1.53	12.60	1.64	13.41	1.75	15.03	1.97	16.74	2.21
	25(77)	8.51	1.15	10.17	1.35	11.79	1.56	12.60	1.67	13.41	1.80	15.03	2.07	16.74	2.36
	27(80.6)	8.51	1.18	10.17	1.40	11.79	1.65	12.60	1.78	13.41	1.91	15.03	2.20	16.74	2.51
	29(84.2)	8.51	1.24	10.17	1.48	11.79	1.75	12.60	1.89	13.41	2.04	15.03	2.34	16.74	2.68
	31(87.8)	8.51	1.31	10.17	1.57	11.79	1.85	12.60	2.01	13.41	2.16	15.03	2.49	16.74	2.85
	33(91.4)	8.51	1.39	10.17	1.66	11.79	1.97	12.60	2.12	13.41	2.29	15.03	2.65	16.74	3.03
35(95)	8.51	1.47	10.17	1.76	11.79	2.08	12.60	2.25	13.41	2.43	15.03	2.81	16.74	3.21	
37(98.6)	8.51	1.54	10.17	1.86	11.79	2.20	12.60	2.38	13.41	2.57	15.03	2.98	16.74	3.42	
39(102.2)	8.51	1.63	10.17	1.96	11.79	2.33	12.60	2.52	13.41	2.73	15.03	3.16	16.74	3.63	
41(105.8)	8.51	1.70	10.17	2.04	11.79	2.41	12.60	2.64	13.41	2.85	15.03	3.33	16.74	3.80	
43(109.4)	8.51	1.81	10.17	2.18	11.79	2.49	12.60	2.76	13.41	2.92	15.03	3.50	16.74	3.97	
45(113)	8.51	1.85	10.17	2.24	11.79	2.66	12.60	2.97	13.41	3.05	15.03	3.83	16.74	4.30	
48(118.4)	8.51	1.98	10.17	2.41	11.79	2.77	12.60	3.10	13.41	3.14	15.03	4.06	16.74	4.53	

**Cooling capacity table**

**MVD-V5X280W/V2GN1**

TC: Total Capacity (kW); PI: Power Input (kW) (Compressor + Outdoor fan motor)

Combination (%)	Outdoor temperature (°C(°F) DB)	Indoor temperature(°C(°F))													
		DB:20.8(69.4) WB:14(57.2)		DB:23.3(73.9) WB:16(60.8)		DB:25.8(78.4) WB:18(64.4)		DB:27(80.6) WB:19(66.2)		DB:28.2(82.8) WB:20(68)		DB:30.7(87.3) WB:22(71.6)		DB:32(89.6) WB:24(75.2)	
		TC	PI	TC	PI	TC	PI	TC	PI	TC	PI	TC	PI	TC	PI
		kW	kW	kW	kW	kW	kW	kW	kW	kW	kW	kW	kW	kW	kW
130%	-5(23)	24.60	2.87	29.30	3.50	34.00	3.75	35.30	3.91	37.00	4.02	37.90	4.37	38.85	4.40
	-2(28.4)	24.60	2.87	29.30	3.57	34.00	3.75	35.30	3.93	37.00	4.02	37.90	4.42	38.85	4.44
	0(32)	24.60	2.92	29.30	3.63	34.00	3.89	35.30	4.15	37.00	4.25	37.90	4.48	38.85	4.50
	2(35.6)	24.60	2.97	29.30	3.64	34.00	4.03	35.30	4.38	37.00	4.30	37.90	4.51	38.85	4.57
	4(39.2)	24.60	3.04	29.30	3.71	34.00	4.16	35.30	4.40	37.00	4.36	37.90	4.51	38.85	4.65
	6(42.8)	24.60	3.10	29.30	3.78	34.00	4.32	35.30	4.43	36.58	4.49	37.43	4.51	38.43	4.69
	8(46.4)	24.60	3.17	29.30	3.87	34.00	4.53	35.30	4.65	36.13	4.64	37.03	3.90	37.93	4.73
	10(50)	24.60	3.24	29.30	3.96	34.00	4.70	35.30	4.81	35.70	4.04	36.60	4.06	37.50	4.87
	12(53.6)	24.60	3.29	29.30	4.03	34.00	4.80	34.80	4.03	35.30	4.06	36.10	4.07	37.00	4.90
	14(57.2)	24.60	3.36	29.30	4.11	33.90	4.05	34.40	4.06	34.80	4.08	35.70	4.09	36.60	5.01
	16(60.8)	24.60	3.42	29.30	4.19	33.50	4.06	33.90	4.08	34.30	4.10	35.20	4.12	36.10	5.09
	18(64.4)	24.60	3.48	29.30	4.28	33.00	5.01	33.40	5.04	33.90	5.07	34.80	5.12	35.70	5.17
	20(68)	24.60	3.56	29.30	4.55	32.50	5.26	33.00	5.29	33.40	5.32	34.30	5.36	35.20	5.42
	21(69.8)	24.60	3.65	29.30	4.71	32.30	5.38	32.80	5.41	33.20	5.44	34.10	5.50	35.00	5.54
	23(73.4)	24.60	3.92	29.30	5.05	31.90	5.63	32.30	5.66	32.70	5.69	33.60	5.74	34.50	5.80
	25(77)	24.60	4.18	29.30	5.41	31.40	5.88	31.80	5.90	32.30	5.94	33.20	6.00	34.10	6.06
	27(80.6)	24.60	4.47	29.30	5.79	31.00	6.12	31.40	6.16	31.80	6.19	32.70	6.25	33.60	6.32
	29(84.2)	24.60	4.77	29.30	6.19	30.50	6.37	30.90	6.41	31.40	6.44	32.30	6.51	33.20	6.58
	31(87.8)	24.60	5.09	29.20	6.55	30.00	6.62	30.50	6.66	30.90	6.69	31.80	6.76	32.70	6.84
	33(91.4)	24.60	5.42	28.70	6.79	29.60	6.87	30.00	6.91	30.50	6.94	31.40	7.02	32.20	7.10
35(95)	24.60	5.78	28.20	7.04	29.10	7.12	29.60	7.16	30.00	7.20	30.90	7.29	31.80	7.36	
37(98.6)	24.60	6.15	27.80	7.30	28.70	7.38	29.10	7.42	29.60	7.47	30.40	7.55	31.30	7.64	
39(102.2)	24.60	6.55	27.30	7.37	28.20	7.63	28.70	7.67	29.10	7.72	30.00	7.81	30.90	7.90	
41(105.8)	24.60	6.89	27.02	7.44	27.90	7.70	28.40	7.74	28.80	7.79	29.70	7.82	29.71	7.97	
43(109.4)	24.60	7.07	26.82	7.48	27.75	7.72	28.26	7.78	28.51	7.80	29.16	7.84	29.36	7.99	
45(113)	24.60	7.42	26.65	7.55	27.46	7.79	27.96	7.83	28.09	7.84	28.37	7.86	28.78	8.14	
48(118.4)	24.60	7.94	26.56	7.66	27.01	7.94	27.52	7.87	27.74	7.91	27.62	7.91	28.12	8.54	
120%	-5(23)	22.70	2.77	27.00	3.36	31.40	3.97	33.60	4.33	35.20	4.51	36.00	4.66	36.80	4.78
	-2(28.4)	22.70	2.80	27.00	3.39	31.40	4.01	33.60	4.35	35.20	4.57	36.00	4.70	36.80	4.80
	0(32)	22.70	2.82	27.00	3.42	31.40	4.06	33.60	4.36	35.20	4.61	36.00	4.72	36.80	4.81
	2(35.6)	22.70	2.83	27.00	3.45	31.40	4.08	33.60	4.41	35.20	4.62	36.00	4.76	36.80	4.82
	4(39.2)	22.70	2.86	27.00	3.49	31.40	4.14	33.60	4.45	35.20	4.69	36.00	4.77	36.80	4.83
	6(42.8)	22.70	2.89	27.00	3.52	31.40	4.19	33.60	4.50	35.20	4.74	36.00	4.81	36.80	4.85
	8(46.4)	22.70	2.92	27.00	3.56	31.40	4.25	33.60	4.55	35.20	4.78	36.00	4.82	36.80	4.87
	10(50)	22.70	2.95	27.00	3.60	31.40	4.29	33.60	4.64	35.20	4.79	36.00	4.84	36.80	4.89
	12(53.6)	22.70	3.01	27.00	3.67	31.40	4.37	33.60	4.72	34.70	4.81	35.50	4.81	36.30	4.92
	14(57.2)	22.70	3.07	27.00	3.75	31.40	4.46	33.60	4.82	34.20	4.84	35.10	4.88	35.90	4.98
	16(60.8)	22.70	3.12	27.00	3.82	31.40	4.54	33.40	4.10	33.80	4.91	34.60	4.97	35.40	5.06
	18(64.4)	22.70	3.18	27.00	3.90	31.40	4.69	32.90	5.01	33.30	5.03	34.10	5.08	35.00	5.13
	20(68)	22.70	3.25	27.00	4.05	31.40	5.05	32.50	5.26	32.90	5.28	33.70	5.33	34.50	5.37
	21(69.8)	22.70	3.27	27.00	4.19	31.40	5.23	32.20	5.38	32.60	5.40	33.50	5.45	34.30	5.51
	23(73.4)	22.70	3.50	27.00	4.49	31.40	5.60	31.80	5.62	32.20	5.65	33.00	5.71	33.80	5.75
	25(77)	22.70	3.74	27.00	4.81	30.90	5.85	31.30	5.87	31.70	5.89	32.60	5.95	33.40	6.01
	27(80.6)	22.70	3.99	27.00	5.14	30.50	6.08	30.90	6.12	31.30	6.15	32.10	6.21	32.90	6.26
	29(84.2)	22.70	4.26	27.00	5.49	30.00	6.33	30.40	6.37	30.80	6.40	31.60	6.46	32.50	6.52
	31(87.8)	22.70	4.54	27.00	5.86	29.50	6.58	30.00	6.61	30.40	6.65	31.20	6.72	32.00	6.78
	33(91.4)	22.70	4.83	27.00	6.24	29.10	6.83	29.50	6.87	29.90	6.90	30.70	6.97	31.50	7.04
35(95)	22.70	5.15	27.00	6.66	28.60	7.08	29.00	7.11	29.50	7.15	30.30	7.23	31.10	7.30	
37(98.6)	22.70	5.48	27.00	7.10	28.20	7.33	28.60	7.37	29.00	7.41	29.80	7.48	30.60	7.57	
39(102.2)	22.70	5.83	26.90	7.49	27.70	7.58	28.10	7.63	28.50	7.66	29.40	7.75	30.20	7.82	
41(105.8)	22.70	5.99	26.68	7.55	27.48	7.63	27.88	7.68	28.28	7.72	29.18	7.77	29.33	7.88	
43(109.4)	22.70	6.08	26.54	7.60	27.27	7.68	27.67	7.71	28.07	7.74	28.67	7.79	28.88	8.04	
45(113)	22.70	6.15	26.39	7.67	27.00	7.75	27.38	7.78	27.82	7.80	28.09	7.82	28.59	8.22	
48(118.4)	22.70	6.25	26.17	7.78	26.66	7.85	26.94	7.88	27.51	7.95	27.66	7.96	28.21	8.32	

**Cooling capacity table**

**MVD-V5X280W/V2GN1**

TC: Total Capacity (kW); PI: Power Input (kW) (Compressor + Outdoor fan motor)

Combination (%)	Outdoor temperature (°C(°F) DB)	Indoor temperature(°C(°F))													
		DB:20.8(69.4) WB:14(57.2)		DB:23.3(73.9) WB:16(60.8)		DB:25.8(78.4) WB:18(64.4)		DB:27(80.6) WB:19(66.2)		DB:28.2(82.8) WB:20(68)		DB:30.7(87.3) WB:22(71.6)		DB:32(89.6) WB:24(75.2)	
		TC	PI	TC	PI	TC	PI	TC	PI	TC	PI	TC	PI	TC	PI
		kW	kW	kW	kW	kW	kW	kW	kW	kW	kW	kW	kW	kW	kW
110%	-5(23)	20.80	2.42	24.80	3.01	28.80	3.60	30.80	3.86	32.80	4.15	35.30	4.31	36.10	4.45
	-2(28.4)	20.80	2.47	24.80	3.05	28.80	3.63	30.80	3.90	32.80	4.18	35.30	4.36	36.10	4.47
	0(32)	20.80	2.49	24.80	3.07	28.80	3.65	30.80	3.92	32.80	4.23	35.30	4.40	36.10	4.52
	2(35.6)	20.80	2.55	24.80	3.10	28.80	3.71	30.80	3.96	32.80	4.28	35.30	4.46	36.10	4.58
	4(39.2)	20.80	2.60	24.80	3.13	28.80	3.75	30.80	4.01	32.80	4.34	35.30	4.52	36.10	4.62
	6(42.8)	20.80	2.62	24.80	3.17	28.80	3.78	30.80	4.08	32.80	4.39	35.30	4.57	36.10	4.69
	8(46.4)	20.80	2.65	24.80	3.22	28.80	3.83	30.80	4.12	32.80	4.44	35.30	4.60	36.10	4.74
	10(50)	20.80	2.68	24.80	3.26	28.80	3.88	30.80	4.19	32.80	4.51	35.30	4.63	36.10	4.78
	12(53.6)	20.80	2.73	24.80	3.33	28.80	3.96	30.80	4.28	32.80	4.60	34.90	4.70	35.60	4.85
	14(57.2)	20.80	2.78	24.80	3.39	28.80	4.03	30.80	4.35	32.80	4.68	34.40	4.74	35.20	4.88
	16(60.8)	20.80	2.83	24.80	3.45	28.80	4.11	30.80	4.44	32.80	4.78	34.00	4.80	34.70	4.93
	18(64.4)	20.80	2.89	24.80	3.52	28.80	4.19	30.80	4.56	32.80	5.01	33.50	5.04	34.30	5.09
	20(68)	20.80	2.94	24.80	3.60	28.80	4.44	30.80	4.90	32.30	5.25	33.10	5.29	33.80	5.34
	21(69.8)	20.80	2.97	24.80	3.70	28.80	4.60	30.80	5.08	32.10	5.37	32.80	5.41	33.60	5.46
	23(73.4)	20.80	3.11	24.80	3.96	28.80	4.93	30.80	5.45	31.60	5.61	32.40	5.67	33.10	5.71
	25(77)	20.80	3.32	24.80	4.24	28.80	5.27	30.80	5.84	31.20	5.86	31.90	5.91	32.70	5.96
	27(80.6)	20.80	3.54	24.80	4.53	28.80	5.64	30.30	6.08	30.70	6.10	31.50	6.16	32.20	6.22
	29(84.2)	20.80	3.77	24.80	4.84	28.80	6.03	29.90	6.33	30.30	6.36	31.00	6.41	31.80	6.47
	31(87.8)	20.80	4.02	24.80	5.16	28.80	6.43	29.40	6.58	29.80	6.60	30.60	6.66	31.30	6.73
	33(91.4)	20.80	4.28	24.80	5.50	28.60	6.78	29.00	6.82	29.40	6.85	30.10	6.92	30.90	6.98
35(95)	20.80	4.55	24.80	5.86	28.10	7.03	28.50	7.07	28.90	7.11	29.60	7.17	30.40	7.24	
37(98.6)	20.80	4.84	24.80	6.24	27.70	7.29	28.10	7.31	28.40	7.35	29.20	7.43	29.90	7.49	
39(102.2)	20.80	5.15	24.80	6.64	27.20	7.53	27.60	7.57	28.00	7.61	28.70	7.68	29.50	7.76	
41(105.8)	20.80	5.20	24.80	6.70	26.99	7.58	27.39	7.62	27.79	7.66	28.34	7.74	28.61	7.81	
43(109.4)	20.80	5.25	24.80	6.78	26.77	7.64	27.17	7.68	27.57	7.71	28.08	7.76	28.17	7.97	
45(113)	20.80	5.42	24.80	6.82	26.50	7.71	26.89	7.77	27.33	7.78	27.80	7.98	27.91	8.16	
48(118.4)	20.80	5.56	24.80	6.92	26.12	7.81	26.46	7.89	27.02	7.94	27.34	8.29	27.55	8.58	
100%	-5(23)	18.90	2.20	22.50	2.65	26.20	3.16	28.00	3.38	29.80	3.67	33.50	4.18	35.40	4.37
	-2(28.4)	18.90	2.23	22.50	2.69	26.20	3.19	28.00	3.45	29.80	3.72	33.50	4.23	35.40	4.39
	0(32)	18.90	2.25	22.50	2.72	26.20	3.23	28.00	3.49	29.80	3.76	33.50	4.30	35.40	4.44
	2(35.6)	18.90	2.30	22.50	2.75	26.20	3.26	28.00	3.53	29.80	3.80	33.50	4.37	35.40	4.51
	4(39.2)	18.90	2.32	22.50	2.78	26.20	3.31	28.00	3.59	29.80	3.85	33.50	4.41	35.40	4.56
	6(42.8)	18.90	2.35	22.50	2.84	26.20	3.36	28.00	3.65	29.80	3.90	33.50	4.47	35.40	4.63
	8(46.4)	18.90	2.39	22.50	2.88	26.20	3.42	28.00	3.69	29.80	3.97	33.50	4.54	35.40	4.71
	10(50)	18.90	2.42	22.50	2.93	26.20	3.47	28.00	3.76	29.80	4.04	33.50	4.62	35.40	4.78
	12(53.6)	18.90	2.46	22.50	2.99	26.20	3.54	28.00	3.82	29.80	4.12	33.50	4.70	34.90	4.82
	14(57.2)	18.90	2.51	22.50	3.05	26.20	3.60	28.00	3.90	29.80	4.19	33.50	4.80	34.50	4.87
	16(60.8)	18.90	2.55	22.50	3.10	26.20	3.68	28.00	3.97	29.80	4.28	33.30	4.85	34.00	4.93
	18(64.4)	18.90	2.60	22.50	3.16	26.20	3.75	28.00	4.05	29.80	4.36	32.90	5.01	33.60	5.05
	20(68)	18.90	2.65	22.50	3.23	26.20	3.86	28.00	4.26	29.80	4.67	32.40	5.25	33.10	5.30
	21(69.8)	18.90	2.68	22.50	3.25	26.20	4.00	28.00	4.41	29.80	4.83	32.20	5.37	32.90	5.42
	23(73.4)	18.90	2.74	22.50	3.47	26.20	4.29	28.00	4.72	29.80	5.18	31.80	5.62	32.40	5.67
	25(77)	18.90	2.92	22.50	3.71	26.20	4.59	28.00	5.06	29.80	5.55	31.30	5.87	32.00	5.91
	27(80.6)	18.90	3.12	22.50	3.95	26.20	4.90	28.00	5.41	29.80	5.94	30.80	6.11	31.50	6.17
	29(84.2)	18.90	3.32	22.50	4.22	26.20	5.23	28.00	5.78	29.70	6.31	30.40	6.37	31.10	6.41
	31(87.8)	18.90	3.54	22.50	4.50	26.20	5.58	28.00	6.17	29.30	6.56	29.90	6.61	30.60	6.67
	33(91.4)	18.90	3.76	22.50	4.80	26.20	5.95	28.00	6.58	28.80	6.80	29.50	6.86	30.20	6.93
35(95)	18.90	3.99	22.50	5.10	26.20	6.35	28.00	7.02	28.30	7.05	29.00	7.11	29.70	7.17	
37(98.6)	18.90	4.25	22.50	5.43	26.20	6.76	27.50	7.27	27.90	7.30	28.60	7.37	29.20	7.43	
39(102.2)	18.90	4.51	22.50	5.77	26.20	7.20	27.10	7.51	27.40	7.55	28.10	7.62	28.80	7.69	
41(105.8)	18.90	4.72	22.50	5.98	26.20	7.46	26.68	7.56	27.19	7.67	27.78	7.80	28.38	7.85	
43(109.4)	18.90	4.93	22.50	6.19	26.20	7.60	26.26	7.65	26.99	7.74	27.61	7.85	27.88	7.94	
45(113)	18.90	5.21	22.50	6.47	26.20	7.73	26.23	7.76	26.85	7.88	27.32	7.97	27.55	8.04	
48(118.4)	18.90	5.64	22.50	6.89	26.20	7.86	26.21	7.97	26.81	8.18	27.10	8.20	27.38	8.25	

**Cooling capacity table**

**MVD-V5X280W/V2GN1**

TC: Total Capacity (kW); PI: Power Input (kW) (Compressor + Outdoor fan motor)

Combination (%)	Outdoor temperature (°C(°F) DB)	Indoor temperature(°C(°F))													
		DB:20.8(69.4) WB:14(57.2)		DB:23.3(73.9) WB:16(60.8)		DB:25.8(78.4) WB:18(64.4)		DB:27(80.6) WB:19(66.2)		DB:28.2(82.8) WB:20(68)		DB:30.7(87.3) WB:22(71.6)		DB:32(89.6) WB:24(75.2)	
		TC	PI	TC	PI	TC	PI	TC	PI	TC	PI	TC	PI	TC	PI
		kW	kW	kW	kW	kW	kW	kW	kW	kW	kW	kW	kW	kW	kW
90%	-5(23)	17.00	1.95	20.30	2.34	23.60	2.76	25.20	3.01	26.80	3.20	30.10	3.68	33.40	4.22
	-2(28.4)	17.00	1.97	20.30	2.36	23.60	2.80	25.20	3.05	26.80	3.24	30.10	3.72	33.40	4.26
	0(32)	17.00	2.00	20.30	2.39	23.60	2.84	25.20	3.09	26.80	3.28	30.10	3.76	33.40	4.29
	2(35.6)	17.00	2.03	20.30	2.42	23.60	2.87	25.20	3.14	26.80	3.33	30.10	3.84	33.40	4.35
	4(39.2)	17.00	2.06	20.30	2.46	23.60	2.91	25.20	3.18	26.80	3.38	30.10	3.90	33.40	4.42
	6(42.8)	17.00	2.09	20.30	2.51	23.60	2.97	25.20	3.24	26.80	3.44	30.10	3.96	33.40	4.49
	8(46.4)	17.00	2.13	20.30	2.56	23.60	3.03	25.20	3.28	26.80	3.50	30.10	4.03	33.40	4.53
	10(50)	17.00	2.17	20.30	2.61	23.60	3.08	25.20	3.33	26.80	3.58	30.10	4.08	33.40	4.61
	12(53.6)	17.00	2.20	20.30	2.66	23.60	3.14	25.20	3.39	26.80	3.64	30.10	4.16	33.40	4.69
	14(57.2)	17.00	2.24	20.30	2.71	23.60	3.20	25.20	3.45	26.80	3.71	30.10	4.24	33.40	4.78
	16(60.8)	17.00	2.28	20.30	2.75	23.60	3.26	25.20	3.52	26.80	3.78	30.10	4.32	33.30	4.86
	18(64.4)	17.00	2.32	20.30	2.81	23.60	3.32	25.20	3.59	26.80	3.86	30.10	4.41	32.90	5.01
	20(68)	17.00	2.36	20.30	2.87	23.60	3.39	25.20	3.66	26.80	4.00	30.10	4.74	32.40	5.25
	21(69.8)	17.00	2.38	20.30	2.89	23.60	3.44	25.20	3.78	26.80	4.14	30.10	4.91	32.20	5.37
	23(73.4)	17.00	2.43	20.30	3.01	23.60	3.69	25.20	4.06	26.80	4.45	30.10	5.27	31.70	5.62
	25(77)	17.00	2.56	20.30	3.22	23.60	3.94	25.20	4.34	26.80	4.75	30.10	5.64	31.30	5.87
	27(80.6)	17.00	2.72	20.30	3.42	23.60	4.21	25.20	4.64	26.80	5.08	30.10	6.04	30.80	6.11
	29(84.2)	17.00	2.90	20.30	3.65	23.60	4.49	25.20	4.95	26.80	5.43	29.80	6.31	30.40	6.36
	31(87.8)	17.00	3.08	20.30	3.89	23.60	4.79	25.20	5.28	26.80	5.79	29.30	6.56	29.90	6.61
	33(91.4)	17.00	3.27	20.30	4.13	23.60	5.11	25.20	5.63	26.80	6.18	28.90	6.81	29.50	6.86
35(95)	17.00	3.48	20.30	4.40	23.60	5.44	25.20	6.00	26.80	6.58	28.40	7.06	29.00	7.11	
37(98.6)	17.00	3.69	20.30	4.67	23.60	5.79	25.20	6.39	26.80	7.02	27.90	7.30	28.60	7.36	
39(102.2)	17.00	3.92	20.30	4.98	23.60	6.16	25.20	6.80	26.80	7.47	27.50	7.56	28.10	7.62	
41(105.8)	17.00	4.05	20.30	5.20	23.60	6.38	25.20	6.98	26.80	7.52	27.31	7.75	27.91	7.80	
43(109.4)	17.00	4.25	20.30	5.43	23.60	6.61	25.20	7.16	26.80	7.68	27.17	7.85	27.67	7.92	
45(113)	17.00	4.52	20.30	5.70	23.60	6.88	25.20	7.40	26.80	7.89	27.02	7.93	27.25	8.02	
48(118.4)	17.00	4.88	20.30	6.06	23.60	7.24	25.20	7.76	26.80	8.07	26.91	8.09	27.04	8.16	
80%	-5(23)	15.10	1.72	18.00	2.03	20.90	2.40	22.40	2.56	23.90	2.75	26.80	3.18	29.70	3.63
	-2(28.4)	15.10	1.74	18.00	2.06	20.90	2.43	22.40	2.60	23.90	2.78	26.80	3.21	29.70	3.67
	0(32)	15.10	1.77	18.00	2.08	20.90	2.46	22.40	2.63	23.90	2.83	26.80	3.26	29.70	3.72
	2(35.6)	15.10	1.81	18.00	2.11	20.90	2.49	22.40	2.68	23.90	2.88	26.80	3.32	29.70	3.79
	4(39.2)	15.10	1.84	18.00	2.15	20.90	2.54	22.40	2.74	23.90	2.93	26.80	3.39	29.70	3.84
	6(42.8)	15.10	1.87	18.00	2.20	20.90	2.58	22.40	2.80	23.90	2.99	26.80	3.44	29.70	3.91
	8(46.4)	15.10	1.90	18.00	2.25	20.90	2.64	22.40	2.84	23.90	3.05	26.80	3.49	29.70	3.98
	10(50)	15.10	1.92	18.00	2.30	20.90	2.71	22.40	2.91	23.90	3.12	26.80	3.57	29.70	4.02
	12(53.6)	15.10	1.95	18.00	2.34	20.90	2.75	22.40	2.97	23.90	3.19	26.80	3.63	29.70	4.10
	14(57.2)	15.10	1.99	18.00	2.38	20.90	2.80	22.40	3.02	23.90	3.25	26.80	3.70	29.70	4.17
	16(60.8)	15.10	2.02	18.00	2.42	20.90	2.86	22.40	3.07	23.90	3.30	26.80	3.78	29.70	4.25
	18(64.4)	15.10	2.05	18.00	2.47	20.90	2.91	22.40	3.14	23.90	3.37	26.80	3.85	29.70	4.33
	20(68)	15.10	2.09	18.00	2.52	20.90	2.97	22.40	3.20	23.90	3.43	26.80	3.99	29.70	4.64
	21(69.8)	15.10	2.11	18.00	2.54	20.90	3.00	22.40	3.24	23.90	3.51	26.80	4.13	29.70	4.81
	23(73.4)	15.10	2.15	18.00	2.59	20.90	3.14	22.40	3.44	23.90	3.76	26.80	4.43	29.70	5.16
	25(77)	15.10	2.21	18.00	2.75	20.90	3.36	22.40	3.68	23.90	4.01	26.80	4.74	29.70	5.52
	27(80.6)	15.10	2.36	18.00	2.93	20.90	3.58	22.40	3.93	23.90	4.29	26.80	5.06	29.70	5.90
	29(84.2)	15.10	2.51	18.00	3.12	20.90	3.81	22.40	4.18	23.90	4.58	26.80	5.40	29.70	6.31
	31(87.8)	15.10	2.66	18.00	3.32	20.90	4.06	22.40	4.46	23.90	4.88	26.80	5.77	29.20	6.56
	33(91.4)	15.10	2.83	18.00	3.53	20.90	4.32	22.40	4.75	23.90	5.19	26.80	6.15	28.80	6.80
35(95)	15.10	3.00	18.00	3.76	20.90	4.60	22.40	5.05	23.90	5.53	26.80	6.56	28.30	7.05	
37(98.6)	15.10	3.18	18.00	3.98	20.90	4.89	22.40	5.38	23.90	5.89	26.80	6.99	27.90	7.29	
39(102.2)	15.10	3.37	18.00	4.25	20.90	5.20	22.40	5.72	23.90	6.27	26.80	7.45	27.40	7.55	
41(105.8)	15.10	3.44	18.00	4.29	20.90	5.28	22.40	5.88	23.90	6.39	26.80	7.64	27.23	7.68	
43(109.4)	15.10	3.55	18.00	4.32	20.90	5.36	22.40	5.98	23.90	6.48	26.80	7.72	27.06	7.76	
45(113)	15.10	3.65	18.00	4.37	20.90	5.46	22.40	6.10	23.90	6.59	26.80	7.81	26.73	7.89	
48(118.4)	15.10	3.72	18.00	4.45	20.90	5.62	22.40	6.33	23.90	6.77	26.80	7.99	26.50	8.16	

**Cooling capacity table**

**MVD-V5X280W/V2GN1**

TC: Total Capacity (kW); PI: Power Input (kW) (Compressor + Outdoor fan motor)

Combination (%)	Outdoor temperature (°C(°F) DB)	Indoor temperature(°C(°F))													
		DB:20.8(69.4) WB:14(57.2)		DB:23.3(73.9) WB:16(60.8)		DB:25.8(78.4) WB:18(64.4)		DB:27(80.6) WB:19(66.2)		DB:28.2(82.8) WB:20(68)		DB:30.7(87.3) WB:22(71.6)		DB:32(89.6) WB:24(75.2)	
		TC	PI	TC	PI	TC	PI	TC	PI	TC	PI	TC	PI	TC	PI
		kW	kW	kW	kW	kW	kW	kW	kW	kW	kW	kW	kW	kW	kW
70%	-5(23)	13.20	1.53	15.80	1.80	18.30	2.04	19.60	2.18	20.90	2.33	23.40	2.67	26.00	3.07
	-2(28.4)	13.20	1.55	15.80	1.81	18.30	2.05	19.60	2.23	20.90	2.37	23.40	2.71	26.00	3.11
	0(32)	13.20	1.55	15.80	1.83	18.30	2.09	19.60	2.27	20.90	2.42	23.40	2.76	26.00	3.15
	2(35.6)	13.20	1.56	15.80	1.84	18.30	2.13	19.60	2.31	20.90	2.46	23.40	2.82	26.00	3.20
	4(39.2)	13.20	1.58	15.80	1.89	18.30	2.17	19.60	2.35	20.90	2.51	23.40	2.87	26.00	3.28
	6(42.8)	13.20	1.61	15.80	1.92	18.30	2.23	19.60	2.43	20.90	2.57	23.40	2.92	26.00	3.34
	8(46.4)	13.20	1.64	15.80	1.97	18.30	2.28	19.60	2.47	20.90	2.63	23.40	3.00	26.00	3.40
	10(50)	13.20	1.67	15.80	2.01	18.30	2.34	19.60	2.52	20.90	2.70	23.40	3.07	26.00	3.44
	12(53.6)	13.20	1.71	15.80	2.03	18.30	2.38	19.60	2.56	20.90	2.74	23.40	3.12	26.00	3.51
	14(57.2)	13.20	1.74	15.80	2.07	18.30	2.42	19.60	2.60	20.90	2.79	23.40	3.18	26.00	3.58
	16(60.8)	13.20	1.77	15.80	2.11	18.30	2.47	19.60	2.66	20.90	2.85	23.40	3.24	26.00	3.64
	18(64.4)	13.20	1.80	15.80	2.15	18.30	2.52	19.60	2.71	20.90	2.90	23.40	3.30	26.00	3.72
	20(68)	13.20	1.83	15.80	2.19	18.30	2.56	19.60	2.75	20.90	2.95	23.40	3.37	26.00	3.82
	21(69.8)	13.20	1.84	15.80	2.20	18.30	2.58	19.60	2.78	20.90	2.98	23.40	3.42	26.00	3.95
	23(73.4)	13.20	1.87	15.80	2.24	18.30	2.64	19.60	2.88	20.90	3.13	23.40	3.66	26.00	4.24
	25(77)	13.20	1.91	15.80	2.34	18.30	2.81	19.60	3.07	20.90	3.34	23.40	3.92	26.00	4.53
	27(80.6)	13.20	2.02	15.80	2.49	18.30	3.00	19.60	3.27	20.90	3.57	23.40	4.18	26.00	4.84
	29(84.2)	13.20	2.15	15.80	2.64	18.30	3.19	19.60	3.49	20.90	3.79	23.40	4.46	26.00	5.18
	31(87.8)	13.20	2.27	15.80	2.80	18.30	3.40	19.60	3.71	20.90	4.04	23.40	4.75	26.00	5.52
	33(91.4)	13.20	2.41	15.80	2.98	18.30	3.61	19.60	3.95	20.90	4.30	23.40	5.06	26.00	5.88
35(95)	13.20	2.55	15.80	3.16	18.30	3.83	19.60	4.20	20.90	4.58	23.40	5.39	26.00	6.27	
37(98.6)	13.20	2.70	15.80	3.35	18.30	4.08	19.60	4.46	20.90	4.87	23.40	5.74	26.00	6.68	
39(102.2)	13.20	2.86	15.80	3.55	18.30	4.32	19.60	4.74	20.90	5.18	23.40	6.10	26.00	7.11	
41(105.8)	13.20	2.98	15.80	3.67	18.30	4.45	19.60	4.90	20.90	5.33	23.40	6.35	26.00	7.43	
43(109.4)	13.20	3.23	15.80	3.93	18.30	4.63	19.60	5.16	20.90	5.49	23.40	6.59	26.00	7.66	
45(113)	13.20	3.30	15.80	4.01	18.30	4.73	19.60	5.24	20.90	5.76	23.40	6.94	26.00	7.95	
48(118.4)	13.20	3.51	15.80	4.26	18.30	5.02	19.60	5.50	20.90	5.93	23.40	7.15	26.00	8.12	
60%	-5(23)	11.30	1.31	13.50	1.52	15.70	1.77	16.80	1.88	17.90	2.03	20.10	2.28	22.30	2.62
	-2(28.4)	11.30	1.31	13.50	1.54	15.70	1.80	16.80	1.91	17.90	2.05	20.10	2.32	22.30	2.64
	0(32)	11.30	1.34	13.50	1.56	15.70	1.82	16.80	1.93	17.90	2.09	20.10	2.35	22.30	2.67
	2(35.6)	11.30	1.36	13.50	1.60	15.70	1.86	16.80	1.97	17.90	2.12	20.10	2.40	22.30	2.71
	4(39.2)	11.30	1.40	13.50	1.63	15.70	1.89	16.80	2.00	17.90	2.15	20.10	2.44	22.30	2.74
	6(42.8)	11.30	1.41	13.50	1.66	15.70	1.93	16.80	2.04	17.90	2.19	20.10	2.49	22.30	2.81
	8(46.4)	11.30	1.44	13.50	1.68	15.70	1.97	16.80	2.08	17.90	2.24	20.10	2.53	22.30	2.85
	10(50)	11.30	1.47	13.50	1.72	15.70	2.00	16.80	2.14	17.90	2.28	20.10	2.58	22.30	2.89
	12(53.6)	11.30	1.49	13.50	1.75	15.70	2.03	16.80	2.18	17.90	2.32	20.10	2.63	22.30	2.94
	14(57.2)	11.30	1.51	13.50	1.78	15.70	2.06	16.80	2.21	17.90	2.36	20.10	2.68	22.30	3.00
	16(60.8)	11.30	1.53	13.50	1.81	15.70	2.10	16.80	2.25	17.90	2.40	20.10	2.72	22.30	3.06
	18(64.4)	11.30	1.56	13.50	1.84	15.70	2.14	16.80	2.29	17.90	2.45	20.10	2.77	22.30	3.11
	20(68)	11.30	1.58	13.50	1.87	15.70	2.18	16.80	2.34	17.90	2.50	20.10	2.83	22.30	3.18
	21(69.8)	11.30	1.60	13.50	1.88	15.70	2.19	16.80	2.36	17.90	2.52	20.10	2.86	22.30	3.21
	23(73.4)	11.30	1.62	13.50	1.92	15.70	2.23	16.80	2.40	17.90	2.56	20.10	2.97	22.30	3.41
	25(77)	11.30	1.65	13.50	1.95	15.70	2.32	16.80	2.52	17.90	2.72	20.10	3.17	22.30	3.64
	27(80.6)	11.30	1.71	13.50	2.07	15.70	2.47	16.80	2.69	17.90	2.90	20.10	3.38	22.30	3.89
	29(84.2)	11.30	1.81	13.50	2.19	15.70	2.63	16.80	2.86	17.90	3.09	20.10	3.60	22.30	4.15
	31(87.8)	11.30	1.92	13.50	2.33	15.70	2.79	16.80	3.04	17.90	3.29	20.10	3.83	22.30	4.42
	33(91.4)	11.30	2.02	13.50	2.47	15.70	2.96	16.80	3.23	17.90	3.50	20.10	4.08	22.30	4.71
35(95)	11.30	2.15	13.50	2.62	15.70	3.14	16.80	3.42	17.90	3.72	20.10	4.34	22.30	5.01	
37(98.6)	11.30	2.27	13.50	2.77	15.70	3.33	16.80	3.63	17.90	3.94	20.10	4.62	22.30	5.34	
39(102.2)	11.30	2.39	13.50	2.93	15.70	3.53	16.80	3.85	17.90	4.19	20.10	4.90	22.30	5.68	
41(105.8)	11.30	2.47	13.50	3.06	15.70	3.66	16.80	4.00	17.90	4.34	20.10	5.13	22.30	5.93	
43(109.4)	11.30	2.55	13.50	3.19	15.70	3.79	16.80	4.12	17.90	4.50	20.10	5.35	22.30	6.19	
45(113)	11.30	2.67	13.50	3.35	15.70	3.94	16.80	4.28	17.90	4.72	20.10	5.59	22.30	6.53	
48(118.4)	11.30	2.87	13.50	3.57	15.70	4.14	16.80	4.53	17.90	5.09	20.10	5.89	22.30	7.05	

**Cooling capacity table****MVD-V5X280W/V2GN1**

TC: Total Capacity (kW); PI: Power Input (kW) (Compressor + Outdoor fan motor)

Combination (%)	Outdoor temperature (°C(°F) DB)	Indoor temperature(°C(°F))													
		DB:20.8(69.4) WB:14(57.2)		DB:23.3(73.9) WB:16(60.8)		DB:25.8(78.4) WB:18(64.4)		DB:27(80.6) WB:19(66.2)		DB:28.2(82.8) WB:20(68)		DB:30.7(87.3) WB:22(71.6)		DB:32(89.6) WB:24(75.2)	
		TC	PI	TC	PI	TC	PI	TC	PI	TC	PI	TC	PI	TC	PI
		kW	kW	kW	kW	kW	kW	kW	kW	kW	kW	kW	kW	kW	kW
50%	-5(23)	9.45	1.14	11.30	1.31	13.10	1.51	14.00	1.58	14.90	1.67	16.70	1.90	18.60	2.04
	-2(28.4)	9.45	1.14	11.30	1.34	13.10	1.53	14.00	1.60	14.90	1.70	16.70	1.92	18.60	2.07
	0(32)	9.45	1.16	11.30	1.36	13.10	1.55	14.00	1.62	14.90	1.72	16.70	1.95	18.60	2.11
	2(35.6)	9.45	1.18	11.30	1.38	13.10	1.58	14.00	1.65	14.90	1.75	16.70	1.96	18.60	2.15
	4(39.2)	9.45	1.19	11.30	1.40	13.10	1.60	14.00	1.67	14.90	1.78	16.70	2.01	18.60	2.20
	6(42.8)	9.45	1.21	11.30	1.42	13.10	1.62	14.00	1.71	14.90	1.81	16.70	2.04	18.60	2.27
	8(46.4)	9.45	1.24	11.30	1.45	13.10	1.65	14.00	1.74	14.90	1.84	16.70	2.07	18.60	2.34
	10(50)	9.45	1.27	11.30	1.47	13.10	1.67	14.00	1.77	14.90	1.89	16.70	2.13	18.60	2.37
	12(53.6)	9.45	1.28	11.30	1.49	13.10	1.70	14.00	1.81	14.90	1.93	16.70	2.17	18.60	2.41
	14(57.2)	9.45	1.30	11.30	1.50	13.10	1.72	14.00	1.84	14.90	1.96	16.70	2.20	18.60	2.46
	16(60.8)	9.45	1.31	11.30	1.52	13.10	1.75	14.00	1.87	14.90	1.99	16.70	2.24	18.60	2.50
	18(64.4)	9.45	1.33	11.30	1.55	13.10	1.78	14.00	1.90	14.90	2.02	16.70	2.28	18.60	2.54
	20(68)	9.45	1.35	11.30	1.57	13.10	1.81	14.00	1.93	14.90	2.06	16.70	2.32	18.60	2.59
	21(69.8)	9.45	1.36	11.30	1.59	13.10	1.83	14.00	1.95	14.90	2.08	16.70	2.35	18.60	2.62
	23(73.4)	9.45	1.38	11.30	1.61	13.10	1.85	14.00	1.99	14.90	2.12	16.70	2.38	18.60	2.68
	25(77)	9.45	1.40	11.30	1.64	13.10	1.89	14.00	2.02	14.90	2.19	16.70	2.51	18.60	2.86
	27(80.6)	9.45	1.43	11.30	1.70	13.10	2.00	14.00	2.16	14.90	2.32	16.70	2.67	18.60	3.05
	29(84.2)	9.45	1.50	11.30	1.80	13.10	2.12	14.00	2.29	14.90	2.47	16.70	2.84	18.60	3.24
	31(87.8)	9.45	1.59	11.30	1.90	13.10	2.24	14.00	2.43	14.90	2.62	16.70	3.02	18.60	3.45
	33(91.4)	9.45	1.68	11.30	2.02	13.10	2.38	14.00	2.57	14.90	2.78	16.70	3.21	18.60	3.67
35(95)	9.45	1.78	11.30	2.13	13.10	2.52	14.00	2.72	14.90	2.94	16.70	3.41	18.60	3.90	
37(98.6)	9.45	1.87	11.30	2.25	13.10	2.67	14.00	2.89	14.90	3.12	16.70	3.61	18.60	4.14	
39(102.2)	9.45	1.98	11.30	2.37	13.10	2.82	14.00	3.06	14.90	3.31	16.70	3.83	18.60	4.40	
41(105.8)	9.45	2.06	11.30	2.48	13.10	2.92	14.00	3.20	14.90	3.45	16.70	4.04	18.60	4.60	
43(109.4)	9.45	2.20	11.30	2.65	13.10	3.02	14.00	3.34	14.90	3.54	16.70	4.24	18.60	4.81	
45(113)	9.45	2.25	11.30	2.71	13.10	3.23	14.00	3.60	14.90	3.69	16.70	4.65	18.60	5.22	
48(118.4)	9.45	2.40	11.30	2.92	13.10	3.36	14.00	3.76	14.90	3.80	16.70	4.92	18.60	5.49	

**Cooling capacity table**

**MVD-V5X335W/V2GN1**

TC: Total Capacity (kW); PI: Power Input (kW) (Compressor + Outdoor fan motor)

Combination (%)	Outdoor temperature (°C(°F) DB)	Indoor temperature(°C(°F))													
		DB:20.8(69.4) WB:14(57.2)		DB:23.3(73.9) WB:16(60.8)		DB:25.8(78.4) WB:18(64.4)		DB:27(80.6) WB:19(66.2)		DB:28.2(82.8) WB:20(68)		DB:30.7(87.3) WB:22(71.6)		DB:32(89.6) WB:24(75.2)	
		TC	PI	TC	PI	TC	PI	TC	PI	TC	PI	TC	PI	TC	PI
		kW	kW	kW	kW	kW	kW	kW	kW	kW	kW	kW	kW	kW	kW
130%	-5(23)	29.43	3.56	35.05	4.35	40.68	4.66	42.23	4.85	44.26	4.99	45.34	5.42	46.48	5.46
	-2(28.4)	29.43	3.56	35.05	4.43	40.68	4.66	42.23	4.88	44.26	4.99	45.34	5.49	46.48	5.51
	0(32)	29.43	3.62	35.05	4.51	40.68	4.83	42.23	5.14	44.26	5.28	45.34	5.56	46.48	5.58
	2(35.6)	29.43	3.69	35.05	4.52	40.68	4.99	42.23	5.43	44.26	5.34	45.34	5.60	46.48	5.67
	4(39.2)	29.43	3.77	35.05	4.60	40.68	5.17	42.23	5.46	44.26	5.40	45.34	5.59	46.48	5.77
	6(42.8)	29.43	3.84	35.05	4.70	40.68	5.36	42.23	5.50	43.77	5.57	44.79	5.59	45.97	5.82
	8(46.4)	29.43	3.93	35.05	4.80	40.68	5.63	42.23	5.77	43.23	5.76	44.30	3.90	45.39	5.87
	10(50)	29.43	4.02	35.05	4.91	40.68	5.83	42.23	5.96	42.71	4.04	43.79	4.06	44.86	6.04
	12(53.6)	29.43	4.09	35.05	5.00	40.68	5.95	41.63	4.03	42.23	4.06	43.19	4.07	44.27	6.08
	14(57.2)	29.43	4.17	35.05	5.09	40.56	4.05	41.16	4.06	41.63	4.08	42.71	4.09	43.79	6.22
	16(60.8)	29.43	4.24	35.05	5.20	40.08	4.06	40.56	4.08	41.04	4.10	42.11	4.12	43.19	6.32
	18(64.4)	29.43	4.32	35.05	5.31	39.48	6.22	39.96	6.26	40.56	6.29	41.63	6.35	42.71	6.41
	20(68)	29.43	4.41	35.05	5.65	38.88	6.53	39.48	6.56	39.96	6.60	41.04	6.66	42.11	6.73
	21(69.8)	29.43	4.53	35.05	5.85	38.64	6.68	39.24	6.71	39.72	6.75	40.80	6.82	41.87	6.88
	23(73.4)	29.43	4.86	35.05	6.27	38.16	6.99	38.64	7.02	39.12	7.06	40.20	7.13	41.27	7.20
	25(77)	29.43	5.19	35.05	6.71	37.57	7.29	38.04	7.33	38.64	7.37	39.72	7.44	40.80	7.51
	27(80.6)	29.43	5.54	35.05	7.18	37.09	7.60	37.57	7.64	38.04	7.68	39.12	7.76	40.20	7.84
	29(84.2)	29.43	5.92	35.05	7.68	36.49	7.90	36.97	7.95	37.57	7.99	38.64	8.08	39.72	8.16
	31(87.8)	29.43	6.32	34.94	8.12	35.89	8.22	36.49	8.26	36.97	8.30	38.04	8.39	39.12	8.49
	33(91.4)	29.43	6.73	34.33	8.43	35.41	8.52	35.89	8.57	36.49	8.62	37.57	8.71	38.52	8.81
35(95)	29.43	7.17	33.74	8.73	34.81	8.84	35.41	8.89	35.89	8.93	36.97	9.04	38.04	9.13	
37(98.6)	29.43	7.63	33.26	9.05	34.34	9.16	34.81	9.20	35.41	9.26	36.37	9.37	37.45	9.47	
39(102.2)	29.43	8.12	32.66	9.15	33.74	9.46	34.34	9.52	34.81	9.58	35.89	9.68	36.97	9.80	
41(105.8)	29.43	8.55	32.32	9.23	33.38	9.55	33.98	9.61	34.46	9.67	35.54	9.70	35.55	9.89	
43(109.4)	29.43	8.77	32.09	9.28	33.21	9.58	33.81	9.65	34.11	9.68	34.89	9.72	35.13	9.91	
45(113)	29.43	9.20	31.89	9.37	32.85	9.67	33.45	9.72	33.61	9.73	33.94	9.76	34.44	10.10	
48(118.4)	29.43	9.86	31.78	9.50	32.32	9.85	32.92	9.77	33.19	9.82	33.04	9.81	33.64	10.59	
120%	-5(23)	27.16	3.44	32.30	4.16	37.57	4.93	40.20	5.37	42.11	5.60	43.07	5.78	44.03	5.93
	-2(28.4)	27.16	3.47	32.30	4.21	37.57	4.97	40.20	5.40	42.11	5.67	43.07	5.83	44.03	5.95
	0(32)	27.16	3.50	32.30	4.24	37.57	5.03	40.20	5.42	42.11	5.72	43.07	5.86	44.03	5.96
	2(35.6)	27.16	3.51	32.30	4.28	37.57	5.07	40.20	5.47	42.11	5.74	43.07	5.90	44.03	5.98
	4(39.2)	27.16	3.55	32.30	4.34	37.57	5.14	40.20	5.52	42.11	5.81	43.07	5.92	44.03	5.99
	6(42.8)	27.16	3.59	32.30	4.37	37.57	5.20	40.20	5.58	42.11	5.88	43.07	5.97	44.03	6.01
	8(46.4)	27.16	3.62	32.30	4.41	37.57	5.27	40.20	5.65	42.11	5.94	43.07	5.99	44.03	6.04
	10(50)	27.16	3.66	32.30	4.47	37.57	5.32	40.20	5.75	42.11	5.94	43.07	6.00	44.03	6.07
	12(53.6)	27.16	3.73	32.30	4.56	37.57	5.42	40.20	5.86	41.52	5.97	42.47	5.97	43.43	6.11
	14(57.2)	27.16	3.80	32.30	4.65	37.57	5.53	40.20	5.98	40.92	6.00	41.99	6.06	42.95	6.18
	16(60.8)	27.16	3.87	32.30	4.74	37.57	5.63	39.96	4.10	40.44	6.09	41.40	6.16	42.35	6.27
	18(64.4)	27.16	3.94	32.30	4.84	37.57	5.82	39.36	6.22	39.84	6.24	40.80	6.30	41.87	6.36
	20(68)	27.16	4.03	32.30	5.02	37.57	6.27	38.88	6.53	39.36	6.55	40.32	6.61	41.28	6.67
	21(69.8)	27.16	4.06	32.30	5.20	37.57	6.49	38.52	6.68	39.00	6.70	40.08	6.76	41.04	6.83
	23(73.4)	27.16	4.34	32.30	5.58	37.57	6.95	38.05	6.97	38.52	7.01	39.48	7.08	40.44	7.14
	25(77)	27.16	4.64	32.30	5.96	36.97	7.25	37.45	7.28	37.93	7.31	39.00	7.38	39.96	7.45
	27(80.6)	27.16	4.95	32.30	6.37	36.49	7.55	36.97	7.60	37.45	7.63	38.40	7.70	39.36	7.77
	29(84.2)	27.16	5.28	32.30	6.81	35.89	7.85	36.37	7.90	36.85	7.94	37.81	8.02	38.88	8.09
	31(87.8)	27.16	5.63	32.30	7.27	35.29	8.17	35.89	8.21	36.37	8.25	37.33	8.33	38.28	8.42
	33(91.4)	27.16	6.00	32.30	7.75	34.81	8.48	35.29	8.52	35.77	8.56	36.73	8.65	37.69	8.73
35(95)	27.16	6.39	32.30	8.26	34.22	8.78	34.70	8.83	35.29	8.87	36.25	8.97	37.21	9.06	
37(98.6)	27.16	6.80	32.30	8.80	33.74	9.10	34.22	9.14	34.70	9.19	35.65	9.29	36.61	9.39	
39(102.2)	27.16	7.23	32.18	9.30	33.14	9.40	33.62	9.46	34.10	9.51	35.17	9.61	36.13	9.71	
41(105.8)	27.16	7.43	31.92	9.36	32.88	9.47	33.36	9.53	33.84	9.57	34.91	9.64	35.09	9.78	
43(109.4)	27.16	7.54	31.75	9.43	32.62	9.53	33.10	9.56	33.58	9.61	34.31	9.67	34.55	9.98	
45(113)	27.16	7.63	31.58	9.52	32.31	9.62	32.75	9.65	33.28	9.68	33.61	9.70	34.20	10.19	
48(118.4)	27.16	7.76	31.31	9.65	31.89	9.73	32.23	9.77	32.92	9.87	33.09	9.88	33.75	10.33	



**Cooling capacity table**

**MVD-V5X335W/V2GN1**

TC: Total Capacity (kW); PI: Power Input (kW) (Compressor + Outdoor fan motor)

Combination (%)	Outdoor temperature (°C(°F) DB)	Indoor temperature(°C(°F))													
		DB:20.8(69.4) WB:14(57.2)		DB:23.3(73.9) WB:16(60.8)		DB:25.8(78.4) WB:18(64.4)		DB:27(80.6) WB:19(66.2)		DB:28.2(82.8) WB:20(68)		DB:30.7(87.3) WB:22(71.6)		DB:32(89.6) WB:24(75.2)	
		TC	PI	TC	PI	TC	PI	TC	PI	TC	PI	TC	PI	TC	PI
		kW	kW	kW	kW	kW	kW	kW	kW	kW	kW	kW	kW	kW	kW
110%	-5(23)	24.89	3.00	29.67	3.74	34.46	4.46	36.85	4.79	39.24	5.15	42.24	5.35	43.19	5.52
	-2(28.4)	24.89	3.06	29.67	3.79	34.46	4.50	36.85	4.84	39.24	5.19	42.24	5.40	43.19	5.55
	0(32)	24.89	3.09	29.67	3.81	34.46	4.53	36.85	4.87	39.24	5.25	42.24	5.46	43.19	5.61
	2(35.6)	24.89	3.16	29.67	3.84	34.46	4.60	36.85	4.92	39.24	5.31	42.24	5.54	43.19	5.68
	4(39.2)	24.89	3.22	29.67	3.89	34.46	4.65	36.85	4.98	39.24	5.39	42.24	5.61	43.19	5.74
	6(42.8)	24.89	3.25	29.67	3.93	34.46	4.69	36.85	5.06	39.24	5.45	42.24	5.67	43.19	5.82
	8(46.4)	24.89	3.28	29.67	4.00	34.46	4.75	36.85	5.11	39.24	5.51	42.24	5.71	43.19	5.88
	10(50)	24.89	3.32	29.67	4.05	34.46	4.81	36.85	5.20	39.24	5.60	42.24	5.75	43.19	5.94
	12(53.6)	24.89	3.39	29.67	4.13	34.46	4.91	36.85	5.31	39.24	5.71	41.76	5.83	42.59	6.01
	14(57.2)	24.89	3.45	29.67	4.20	34.46	5.00	36.85	5.40	39.24	5.81	41.16	5.88	42.12	6.06
	16(60.8)	24.89	3.51	29.67	4.28	34.46	5.09	36.85	5.51	39.24	5.93	40.68	5.95	41.52	6.12
	18(64.4)	24.89	3.58	29.67	4.37	34.46	5.20	36.85	5.66	39.24	6.21	40.08	6.26	41.04	6.32
	20(68)	24.89	3.65	29.67	4.46	34.46	5.51	36.85	6.08	38.65	6.52	39.60	6.56	40.44	6.62
	21(69.8)	24.89	3.69	29.67	4.59	34.46	5.71	36.85	6.30	38.41	6.67	39.25	6.71	40.20	6.77
	23(73.4)	24.89	3.86	29.67	4.92	34.46	6.12	36.85	6.76	37.81	6.96	38.77	7.03	39.60	7.09
	25(77)	24.89	4.12	29.67	5.26	34.46	6.54	36.85	7.24	37.33	7.27	38.17	7.34	39.12	7.40
	27(80.6)	24.89	4.39	29.67	5.62	34.46	7.00	36.25	7.55	36.73	7.57	37.69	7.64	38.53	7.71
	29(84.2)	24.89	4.68	29.67	6.00	34.46	7.48	35.77	7.85	36.25	7.89	37.09	7.96	38.05	8.03
	31(87.8)	24.89	4.99	29.67	6.40	34.46	7.98	35.18	8.16	35.65	8.19	36.61	8.26	37.45	8.35
	33(91.4)	24.89	5.31	29.67	6.82	34.22	8.42	34.70	8.46	35.18	8.50	36.01	8.58	36.97	8.66
35(95)	24.89	5.65	29.67	7.27	33.62	8.72	34.10	8.77	34.58	8.82	35.42	8.90	36.37	8.98	
37(98.6)	24.89	6.01	29.67	7.74	33.14	9.04	33.62	9.07	33.98	9.12	34.94	9.22	35.77	9.30	
39(102.2)	24.89	6.39	29.67	8.24	32.54	9.34	33.02	9.39	33.50	9.44	34.34	9.53	35.30	9.63	
41(105.8)	24.89	6.45	29.67	8.31	32.29	9.41	32.77	9.46	33.25	9.50	33.90	9.60	34.23	9.69	
43(109.4)	24.89	6.52	29.67	8.41	32.03	9.48	32.51	9.52	32.99	9.57	33.60	9.63	33.71	9.89	
45(113)	24.89	6.73	29.67	8.46	31.71	9.56	32.17	9.64	32.70	9.66	33.26	9.90	33.39	10.12	
48(118.4)	24.89	6.89	29.67	8.59	31.25	9.70	31.66	9.79	32.33	9.85	32.71	10.28	32.96	10.65	
100%	-5(23)	22.61	2.73	26.92	3.29	31.35	3.92	33.50	4.20	35.65	4.56	40.08	5.19	42.35	5.42
	-2(28.4)	22.61	2.77	26.92	3.34	31.35	3.96	33.50	4.28	35.65	4.62	40.08	5.25	42.35	5.45
	0(32)	22.61	2.80	26.92	3.37	31.35	4.01	33.50	4.33	35.65	4.66	40.08	5.34	42.35	5.51
	2(35.6)	22.61	2.85	26.92	3.42	31.35	4.05	33.50	4.39	35.65	4.71	40.08	5.42	42.35	5.60
	4(39.2)	22.61	2.87	26.92	3.45	31.35	4.11	33.50	4.45	35.65	4.77	40.08	5.47	42.35	5.66
	6(42.8)	22.61	2.91	26.92	3.52	31.35	4.16	33.50	4.53	35.65	4.84	40.08	5.55	42.35	5.75
	8(46.4)	22.61	2.97	26.92	3.57	31.35	4.24	33.50	4.58	35.65	4.92	40.08	5.64	42.35	5.84
	10(50)	22.61	3.00	26.92	3.64	31.35	4.31	33.50	4.66	35.65	5.01	40.08	5.73	42.35	5.93
	12(53.6)	22.61	3.05	26.92	3.71	31.35	4.39	33.50	4.74	35.65	5.11	40.08	5.83	41.75	5.97
	14(57.2)	22.61	3.11	26.92	3.78	31.35	4.47	33.50	4.84	35.65	5.20	40.08	5.95	41.28	6.05
	16(60.8)	22.61	3.17	26.92	3.85	31.35	4.57	33.50	4.93	35.65	5.31	39.84	6.02	40.68	6.12
	18(64.4)	22.61	3.23	26.92	3.92	31.35	4.65	33.50	5.02	35.65	5.41	39.36	6.22	40.20	6.27
	20(68)	22.61	3.29	26.92	4.00	31.35	4.79	33.50	5.28	35.65	5.80	38.76	6.52	39.60	6.57
	21(69.8)	22.61	3.32	26.92	4.04	31.35	4.97	33.50	5.47	35.65	6.00	38.53	6.67	39.36	6.73
	23(73.4)	22.61	3.40	26.92	4.31	31.35	5.32	33.50	5.86	35.65	6.43	38.05	6.97	38.76	7.03
	25(77)	22.61	3.63	26.92	4.60	31.35	5.69	33.50	6.28	35.65	6.89	37.45	7.28	38.28	7.34
	27(80.6)	22.61	3.87	26.92	4.91	31.35	6.08	33.50	6.71	35.65	7.37	36.85	7.58	37.69	7.65
	29(84.2)	22.61	4.12	26.92	5.24	31.35	6.49	33.50	7.17	35.53	7.83	36.37	7.90	37.21	7.96
	31(87.8)	22.61	4.39	26.92	5.59	31.35	6.93	33.50	7.65	35.05	8.14	35.77	8.20	36.61	8.28
	33(91.4)	22.61	4.66	26.92	5.95	31.35	7.38	33.50	8.17	34.46	8.44	35.30	8.51	36.13	8.59
35(95)	22.61	4.95	26.92	6.33	31.35	7.88	33.50	8.71	33.86	8.74	34.70	8.83	35.53	8.90	
37(98.6)	22.61	5.27	26.92	6.74	31.35	8.39	32.90	9.01	33.38	9.06	34.22	9.14	34.94	9.22	
39(102.2)	22.61	5.60	26.92	7.16	31.35	8.93	32.42	9.32	32.78	9.37	33.62	9.45	34.46	9.54	
41(105.8)	22.61	5.86	26.92	7.42	31.35	9.26	31.92	9.39	32.53	9.51	33.23	9.67	33.96	9.74	
43(109.4)	22.61	6.12	26.92	7.68	31.35	9.43	31.42	9.49	32.29	9.60	33.03	9.74	33.36	9.85	
45(113)	22.61	6.47	26.92	8.03	31.35	9.59	31.39	9.63	32.13	9.78	32.69	9.88	32.96	9.98	
48(118.4)	22.61	6.99	26.92	8.55	31.35	9.76	31.36	9.89	32.08	10.15	32.42	10.17	32.76	10.24	

**Cooling capacity table**

**MVD-V5X335W/V2GN1**

TC: Total Capacity (kW); PI: Power Input (kW) (Compressor + Outdoor fan motor)

Combination (%)	Outdoor temperature (°C(°F) DB)	Indoor temperature(°C(°F))													
		DB:20.8(69.4) WB:14(57.2)		DB:23.3(73.9) WB:16(60.8)		DB:25.8(78.4) WB:18(64.4)		DB:27(80.6) WB:19(66.2)		DB:28.2(82.8) WB:20(68)		DB:30.7(87.3) WB:22(71.6)		DB:32(89.6) WB:24(75.2)	
		TC	PI	TC	PI	TC	PI	TC	PI	TC	PI	TC	PI	TC	PI
		kW	kW	kW	kW	kW	kW	kW	kW	kW	kW	kW	kW	kW	kW
90%	-5(23)	20.34	2.42	24.29	2.90	28.24	3.42	30.15	3.74	32.06	3.97	36.01	4.57	39.96	5.23
	-2(28.4)	20.34	2.44	24.29	2.93	28.24	3.47	30.15	3.79	32.06	4.02	36.01	4.61	39.96	5.28
	0(32)	20.34	2.48	24.29	2.97	28.24	3.52	30.15	3.83	32.06	4.07	36.01	4.67	39.96	5.32
	2(35.6)	20.34	2.52	24.29	3.01	28.24	3.56	30.15	3.89	32.06	4.14	36.01	4.76	39.96	5.40
	4(39.2)	20.34	2.55	24.29	3.05	28.24	3.62	30.15	3.94	32.06	4.19	36.01	4.84	39.96	5.48
	6(42.8)	20.34	2.59	24.29	3.11	28.24	3.68	30.15	4.02	32.06	4.26	36.01	4.91	39.96	5.57
	8(46.4)	20.34	2.64	24.29	3.17	28.24	3.76	30.15	4.07	32.06	4.34	36.01	5.00	39.96	5.63
	10(50)	20.34	2.69	24.29	3.24	28.24	3.83	30.15	4.13	32.06	4.44	36.01	5.07	39.96	5.72
	12(53.6)	20.34	2.73	24.29	3.30	28.24	3.90	30.15	4.20	32.06	4.52	36.01	5.16	39.96	5.82
	14(57.2)	20.34	2.78	24.29	3.36	28.24	3.97	30.15	4.28	32.06	4.60	36.01	5.26	39.96	5.93
	16(60.8)	20.34	2.83	24.29	3.42	28.24	4.05	30.15	4.37	32.06	4.70	36.01	5.36	39.84	6.03
	18(64.4)	20.34	2.88	24.29	3.49	28.24	4.12	30.15	4.45	32.06	4.79	36.01	5.47	39.36	6.22
	20(68)	20.34	2.93	24.29	3.57	28.24	4.20	30.15	4.54	32.06	4.97	36.01	5.88	38.76	6.51
	21(69.8)	20.34	2.96	24.29	3.59	28.24	4.27	30.15	4.70	32.06	5.14	36.01	6.09	38.53	6.67
	23(73.4)	20.34	3.02	24.29	3.73	28.24	4.58	30.15	5.04	32.06	5.52	36.01	6.54	37.93	6.97
	25(77)	20.34	3.18	24.29	3.99	28.24	4.89	30.15	5.39	32.06	5.89	36.01	7.00	37.45	7.28
	27(80.6)	20.34	3.38	24.29	4.25	28.24	5.22	30.15	5.75	32.06	6.30	36.01	7.49	36.85	7.58
	29(84.2)	20.34	3.60	24.29	4.53	28.24	5.58	30.15	6.14	32.06	6.74	35.65	7.83	36.37	7.89
	31(87.8)	20.34	3.83	24.29	4.82	28.24	5.94	30.15	6.55	32.06	7.18	35.06	8.13	35.77	8.20
	33(91.4)	20.34	4.06	24.29	5.13	28.24	6.34	30.15	6.98	32.06	7.67	34.58	8.45	35.29	8.51
35(95)	20.34	4.32	24.29	5.46	28.24	6.75	30.15	7.44	32.06	8.17	33.98	8.76	34.70	8.83	
37(98.6)	20.34	4.58	24.29	5.80	28.24	7.18	30.15	7.92	32.06	8.71	33.38	9.06	34.22	9.13	
39(102.2)	20.34	4.86	24.29	6.17	28.24	7.64	30.15	8.44	32.06	9.27	32.90	9.38	33.62	9.45	
41(105.8)	20.34	5.03	24.29	6.45	28.24	7.92	30.15	8.66	32.06	9.33	32.67	9.62	33.39	9.67	
43(109.4)	20.34	5.27	24.29	6.73	28.24	8.20	30.15	8.89	32.06	9.53	32.51	9.74	33.11	9.82	
45(113)	20.34	5.60	24.29	7.07	28.24	8.53	30.15	9.18	32.06	9.79	32.32	9.84	32.60	9.95	
48(118.4)	20.34	6.05	24.29	7.51	28.24	8.98	30.15	9.63	32.06	10.01	32.20	10.04	32.35	10.12	
80%	-5(23)	18.07	2.13	21.54	2.52	25.00	2.98	26.80	3.17	28.60	3.42	32.06	3.95	35.53	4.51
	-2(28.4)	18.07	2.16	21.54	2.55	25.00	3.01	26.80	3.22	28.60	3.45	32.06	3.99	35.53	4.55
	0(32)	18.07	2.20	21.54	2.58	25.00	3.05	26.80	3.26	28.60	3.51	32.06	4.04	35.53	4.61
	2(35.6)	18.07	2.24	21.54	2.62	25.00	3.09	26.80	3.32	28.60	3.57	32.06	4.12	35.53	4.70
	4(39.2)	18.07	2.28	21.54	2.66	25.00	3.15	26.80	3.40	28.60	3.64	32.06	4.20	35.53	4.76
	6(42.8)	18.07	2.32	21.54	2.73	25.00	3.20	26.80	3.47	28.60	3.70	32.06	4.26	35.53	4.85
	8(46.4)	18.07	2.36	21.54	2.79	25.00	3.27	26.80	3.53	28.60	3.79	32.06	4.33	35.53	4.94
	10(50)	18.07	2.38	21.54	2.85	25.00	3.36	26.80	3.62	28.60	3.87	32.06	4.43	35.53	4.99
	12(53.6)	18.07	2.42	21.54	2.90	25.00	3.42	26.80	3.69	28.60	3.96	32.06	4.51	35.53	5.08
	14(57.2)	18.07	2.47	21.54	2.96	25.00	3.47	26.80	3.74	28.60	4.03	32.06	4.59	35.53	5.18
	16(60.8)	18.07	2.50	21.54	3.01	25.00	3.54	26.80	3.82	28.60	4.10	32.06	4.68	35.53	5.27
	18(64.4)	18.07	2.55	21.54	3.06	25.00	3.62	26.80	3.90	28.60	4.18	32.06	4.78	35.53	5.38
	20(68)	18.07	2.59	21.54	3.12	25.00	3.69	26.80	3.97	28.60	4.26	32.06	4.95	35.53	5.75
	21(69.8)	18.07	2.62	21.54	3.15	25.00	3.72	26.80	4.01	28.60	4.36	32.06	5.13	35.53	5.96
	23(73.4)	18.07	2.66	21.54	3.22	25.00	3.90	26.80	4.27	28.60	4.66	32.06	5.49	35.53	6.40
	25(77)	18.07	2.75	21.54	3.42	25.00	4.17	26.80	4.57	28.60	4.98	32.06	5.88	35.53	6.84
	27(80.6)	18.07	2.92	21.54	3.64	25.00	4.44	26.80	4.87	28.60	5.32	32.06	6.28	35.53	7.32
	29(84.2)	18.07	3.11	21.54	3.87	25.00	4.73	26.80	5.19	28.60	5.68	32.06	6.70	35.53	7.83
	31(87.8)	18.07	3.30	21.54	4.12	25.00	5.04	26.80	5.53	28.60	6.06	32.06	7.16	34.94	8.14
	33(91.4)	18.07	3.51	21.54	4.38	25.00	5.36	26.80	5.89	28.60	6.44	32.06	7.63	34.46	8.44
35(95)	18.07	3.72	21.54	4.66	25.00	5.71	26.80	6.27	28.60	6.87	32.06	8.14	33.86	8.75	
37(98.6)	18.07	3.94	21.54	4.94	25.00	6.07	26.80	6.68	28.60	7.31	32.06	8.68	33.38	9.05	
39(102.2)	18.07	4.18	21.54	5.27	25.00	6.46	26.80	7.10	28.60	7.78	32.06	9.24	32.78	9.37	
41(105.8)	18.07	4.27	21.54	5.32	25.00	6.55	26.80	7.29	28.60	7.92	32.06	9.47	32.58	9.53	
43(109.4)	18.07	4.40	21.54	5.36	25.00	6.64	26.80	7.42	28.60	8.03	32.06	9.58	32.38	9.63	
45(113)	18.07	4.52	21.54	5.43	25.00	6.77	26.80	7.57	28.60	8.17	32.06	9.69	31.98	9.79	
48(118.4)	18.07	4.62	21.54	5.52	25.00	6.97	26.80	7.85	28.60	8.40	32.06	9.91	31.71	10.13	

**Cooling capacity table**

**MVD-V5X335W/V2GN1**

TC: Total Capacity (kW); PI: Power Input (kW) (Compressor + Outdoor fan motor)

Combination (%)	Outdoor temperature (°C(°F) DB)	Indoor temperature(°C(°F))													
		DB:20.8(69.4) WB:14(57.2)		DB:23.3(73.9) WB:16(60.8)		DB:25.8(78.4) WB:18(64.4)		DB:27(80.6) WB:19(66.2)		DB:28.2(82.8) WB:20(68)		DB:30.7(87.3) WB:22(71.6)		DB:32(89.6) WB:24(75.2)	
		TC	PI	TC	PI	TC	PI	TC	PI	TC	PI	TC	PI	TC	PI
		kW	kW	kW	kW	kW	kW	kW	kW	kW	kW	kW	kW	kW	kW
70%	-5(23)	15.79	1.90	18.90	2.23	21.90	2.53	23.45	2.71	25.00	2.89	28.00	3.31	31.11	3.80
	-2(28.4)	15.79	1.92	18.90	2.24	21.90	2.54	23.45	2.76	25.00	2.94	28.00	3.36	31.11	3.86
	0(32)	15.79	1.93	18.90	2.27	21.90	2.60	23.45	2.81	25.00	3.00	28.00	3.43	31.11	3.91
	2(35.6)	15.79	1.94	18.90	2.28	21.90	2.64	23.45	2.87	25.00	3.05	28.00	3.50	31.11	3.97
	4(39.2)	15.79	1.96	18.90	2.34	21.90	2.70	23.45	2.92	25.00	3.12	28.00	3.56	31.11	4.07
	6(42.8)	15.79	2.00	18.90	2.38	21.90	2.76	23.45	3.01	25.00	3.19	28.00	3.62	31.11	4.14
	8(46.4)	15.79	2.03	18.90	2.45	21.90	2.82	23.45	3.06	25.00	3.26	28.00	3.73	31.11	4.22
	10(50)	15.79	2.07	18.90	2.49	21.90	2.90	23.45	3.12	25.00	3.35	28.00	3.80	31.11	4.27
	12(53.6)	15.79	2.12	18.90	2.52	21.90	2.96	23.45	3.18	25.00	3.40	28.00	3.87	31.11	4.36
	14(57.2)	15.79	2.16	18.90	2.57	21.90	3.01	23.45	3.23	25.00	3.46	28.00	3.94	31.11	4.44
	16(60.8)	15.79	2.20	18.90	2.62	21.90	3.06	23.45	3.30	25.00	3.53	28.00	4.01	31.11	4.52
	18(64.4)	15.79	2.23	18.90	2.66	21.90	3.12	23.45	3.36	25.00	3.59	28.00	4.10	31.11	4.61
	20(68)	15.79	2.27	18.90	2.71	21.90	3.18	23.45	3.42	25.00	3.66	28.00	4.18	31.11	4.74
	21(69.8)	15.79	2.29	18.90	2.74	21.90	3.20	23.45	3.45	25.00	3.70	28.00	4.24	31.11	4.91
	23(73.4)	15.79	2.32	18.90	2.78	21.90	3.28	23.45	3.57	25.00	3.89	28.00	4.54	31.11	5.26
	25(77)	15.79	2.37	18.90	2.90	21.90	3.49	23.45	3.82	25.00	4.14	28.00	4.86	31.11	5.62
	27(80.6)	15.79	2.51	18.90	3.09	21.90	3.72	23.45	4.06	25.00	4.43	28.00	5.19	31.11	6.01
	29(84.2)	15.79	2.66	18.90	3.28	21.90	3.96	23.45	4.33	25.00	4.71	28.00	5.53	31.11	6.42
	31(87.8)	15.79	2.82	18.90	3.47	21.90	4.21	23.45	4.60	25.00	5.01	28.00	5.89	31.11	6.84
	33(91.4)	15.79	2.99	18.90	3.70	21.90	4.48	23.45	4.90	25.00	5.34	28.00	6.28	31.11	7.30
35(95)	15.79	3.17	18.90	3.92	21.90	4.75	23.45	5.21	25.00	5.68	28.00	6.69	31.11	7.78	
37(98.6)	15.79	3.35	18.90	4.16	21.90	5.06	23.45	5.53	25.00	6.05	28.00	7.13	31.11	8.29	
39(102.2)	15.79	3.55	18.90	4.40	21.90	5.36	23.45	5.88	25.00	6.42	28.00	7.57	31.11	8.83	
41(105.8)	15.79	3.70	18.90	4.56	21.90	5.52	23.45	6.08	25.00	6.62	28.00	7.88	31.11	9.22	
43(109.4)	15.79	4.00	18.90	4.87	21.90	5.75	23.45	6.40	25.00	6.81	28.00	8.17	31.11	9.51	
45(113)	15.79	4.09	18.90	4.98	21.90	5.87	23.45	6.51	25.00	7.15	28.00	8.61	31.11	9.87	
48(118.4)	15.79	4.36	18.90	5.29	21.90	6.23	23.45	6.82	25.00	7.36	28.00	8.87	31.11	10.08	
60%	-5(23)	13.52	1.62	16.15	1.88	18.78	2.19	20.10	2.34	21.42	2.52	24.05	2.83	26.68	3.25
	-2(28.4)	13.52	1.63	16.15	1.91	18.78	2.23	20.10	2.37	21.42	2.55	24.05	2.88	26.68	3.27
	0(32)	13.52	1.66	16.15	1.94	18.78	2.26	20.10	2.40	21.42	2.59	24.05	2.92	26.68	3.31
	2(35.6)	13.52	1.69	16.15	1.98	18.78	2.30	20.10	2.45	21.42	2.63	24.05	2.98	26.68	3.36
	4(39.2)	13.52	1.73	16.15	2.02	18.78	2.35	20.10	2.48	21.42	2.67	24.05	3.03	26.68	3.40
	6(42.8)	13.52	1.75	16.15	2.06	18.78	2.39	20.10	2.53	21.42	2.72	24.05	3.09	26.68	3.48
	8(46.4)	13.52	1.78	16.15	2.09	18.78	2.44	20.10	2.58	21.42	2.77	24.05	3.14	26.68	3.54
	10(50)	13.52	1.82	16.15	2.14	18.78	2.48	20.10	2.65	21.42	2.83	24.05	3.20	26.68	3.59
	12(53.6)	13.52	1.85	16.15	2.17	18.78	2.52	20.10	2.70	21.42	2.88	24.05	3.26	26.68	3.65
	14(57.2)	13.52	1.88	16.15	2.21	18.78	2.56	20.10	2.75	21.42	2.93	24.05	3.32	26.68	3.72
	16(60.8)	13.52	1.90	16.15	2.24	18.78	2.61	20.10	2.79	21.42	2.98	24.05	3.38	26.68	3.79
	18(64.4)	13.52	1.94	16.15	2.28	18.78	2.65	20.10	2.84	21.42	3.04	24.05	3.44	26.68	3.86
	20(68)	13.52	1.96	16.15	2.32	18.78	2.70	20.10	2.90	21.42	3.10	24.05	3.51	26.68	3.94
	21(69.8)	13.52	1.98	16.15	2.34	18.78	2.72	20.10	2.92	21.42	3.12	24.05	3.54	26.68	3.98
	23(73.4)	13.52	2.01	16.15	2.38	18.78	2.77	20.10	2.98	21.42	3.18	24.05	3.69	26.68	4.24
	25(77)	13.52	2.04	16.15	2.42	18.78	2.88	20.10	3.12	21.42	3.38	24.05	3.93	26.68	4.52
	27(80.6)	13.52	2.12	16.15	2.57	18.78	3.06	20.10	3.33	21.42	3.60	24.05	4.19	26.68	4.82
	29(84.2)	13.52	2.24	16.15	2.72	18.78	3.26	20.10	3.54	21.42	3.84	24.05	4.47	26.68	5.15
	31(87.8)	13.52	2.38	16.15	2.89	18.78	3.46	20.10	3.77	21.42	4.08	24.05	4.75	26.68	5.48
	33(91.4)	13.52	2.51	16.15	3.06	18.78	3.67	20.10	4.00	21.42	4.34	24.05	5.06	26.68	5.84
35(95)	13.52	2.66	16.15	3.25	18.78	3.90	20.10	4.25	21.42	4.61	24.05	5.39	26.68	6.22	
37(98.6)	13.52	2.82	16.15	3.44	18.78	4.13	20.10	4.51	21.42	4.89	24.05	5.73	26.68	6.62	
39(102.2)	13.52	2.97	16.15	3.64	18.78	4.38	20.10	4.78	21.42	5.20	24.05	6.08	26.68	7.04	
41(105.8)	13.52	3.07	16.15	3.80	18.78	4.54	20.10	4.97	21.42	5.39	24.05	6.37	26.68	7.36	
43(109.4)	13.52	3.16	16.15	3.96	18.78	4.70	20.10	5.12	21.42	5.58	24.05	6.64	26.68	7.68	
45(113)	13.52	3.31	16.15	4.16	18.78	4.89	20.10	5.31	21.42	5.86	24.05	6.93	26.68	8.10	
48(118.4)	13.52	3.56	16.15	4.43	18.78	5.14	20.10	5.63	21.42	6.31	24.05	7.30	26.68	8.74	

**Cooling capacity table****MVD-V5X335W/V2GN1**

TC: Total Capacity (kW); PI: Power Input (kW) (Compressor + Outdoor fan motor)

Combination (%)	Outdoor temperature (°C(°F) DB)	Indoor temperature(°C(°F))													
		DB:20.8(69.4) WB:14(57.2)		DB:23.3(73.9) WB:16(60.8)		DB:25.8(78.4) WB:18(64.4)		DB:27(80.6) WB:19(66.2)		DB:28.2(82.8) WB:20(68)		DB:30.7(87.3) WB:22(71.6)		DB:32(89.6) WB:24(75.2)	
		TC	PI	TC	PI	TC	PI	TC	PI	TC	PI	TC	PI	TC	PI
		kW	kW	kW	kW	kW	kW	kW	kW	kW	kW	kW	kW	kW	kW
50%	-5(23)	11.31	1.41	13.52	1.63	15.67	1.87	16.75	1.96	17.83	2.07	19.98	2.35	22.25	2.54
	-2(28.4)	11.31	1.42	13.52	1.66	15.67	1.89	16.75	1.99	17.83	2.11	19.98	2.38	22.25	2.57
	0(32)	11.31	1.44	13.52	1.69	15.67	1.93	16.75	2.01	17.83	2.13	19.98	2.42	22.25	2.61
	2(35.6)	11.31	1.46	13.52	1.71	15.67	1.96	16.75	2.05	17.83	2.17	19.98	2.43	22.25	2.66
	4(39.2)	11.31	1.48	13.52	1.74	15.67	1.98	16.75	2.07	17.83	2.21	19.98	2.49	22.25	2.73
	6(42.8)	11.31	1.51	13.52	1.77	15.67	2.01	16.75	2.12	17.83	2.25	19.98	2.53	22.25	2.81
	8(46.4)	11.31	1.54	13.52	1.80	15.67	2.05	16.75	2.16	17.83	2.28	19.98	2.57	22.25	2.90
	10(50)	11.31	1.57	13.52	1.82	15.67	2.08	16.75	2.20	17.83	2.35	19.98	2.64	22.25	2.95
	12(53.6)	11.31	1.58	13.52	1.84	15.67	2.11	16.75	2.24	17.83	2.39	19.98	2.69	22.25	2.99
	14(57.2)	11.31	1.61	13.52	1.87	15.67	2.14	16.75	2.29	17.83	2.43	19.98	2.73	22.25	3.05
	16(60.8)	11.31	1.63	13.52	1.89	15.67	2.17	16.75	2.32	17.83	2.46	19.98	2.78	22.25	3.10
	18(64.4)	11.31	1.66	13.52	1.92	15.67	2.21	16.75	2.36	17.83	2.51	19.98	2.83	22.25	3.16
	20(68)	11.31	1.68	13.52	1.95	15.67	2.24	16.75	2.39	17.83	2.56	19.98	2.88	22.25	3.22
	21(69.8)	11.31	1.69	13.52	1.97	15.67	2.27	16.75	2.42	17.83	2.58	19.98	2.91	22.25	3.25
	23(73.4)	11.31	1.71	13.52	2.00	15.67	2.30	16.75	2.46	17.83	2.63	19.98	2.96	22.25	3.32
	25(77)	11.31	1.74	13.52	2.03	15.67	2.35	16.75	2.51	17.83	2.71	19.98	3.11	22.25	3.54
	27(80.6)	11.31	1.77	13.52	2.11	15.67	2.48	16.75	2.68	17.83	2.88	19.98	3.31	22.25	3.78
	29(84.2)	11.31	1.87	13.52	2.23	15.67	2.63	16.75	2.84	17.83	3.06	19.98	3.52	22.25	4.03
	31(87.8)	11.31	1.97	13.52	2.36	15.67	2.78	16.75	3.02	17.83	3.25	19.98	3.74	22.25	4.28
	33(91.4)	11.31	2.09	13.52	2.50	15.67	2.96	16.75	3.19	17.83	3.45	19.98	3.98	22.25	4.55
35(95)	11.31	2.21	13.52	2.64	15.67	3.12	16.75	3.38	17.83	3.65	19.98	4.23	22.25	4.84	
37(98.6)	11.31	2.32	13.52	2.79	15.67	3.31	16.75	3.58	17.83	3.87	19.98	4.48	22.25	5.14	
39(102.2)	11.31	2.45	13.52	2.95	15.67	3.50	16.75	3.79	17.83	4.11	19.98	4.75	22.25	5.46	
41(105.8)	11.31	2.55	13.52	3.07	15.67	3.62	16.75	3.97	17.83	4.29	19.98	5.01	22.25	5.71	
43(109.4)	11.31	2.72	13.52	3.28	15.67	3.75	16.75	4.15	17.83	4.40	19.98	5.26	22.25	5.96	
45(113)	11.31	2.79	13.52	3.37	15.67	4.00	16.75	4.47	17.83	4.58	19.98	5.77	22.25	6.47	
48(118.4)	11.31	2.97	13.52	3.62	15.67	4.17	16.75	4.67	17.83	4.72	19.98	6.11	22.25	6.81	

**Cooling capacity table**

**MVD-V5X400W/V2GN1**

TC: Total Capacity (kW); PI: Power Input (kW) (Compressor + Outdoor fan motor)

Combination (%)	Outdoor temperature (°C(°F) DB)	Indoor temperature(°C(°F))													
		DB:20.8(69.4) WB:14(57.2)		DB:23.3(73.9) WB:16(60.8)		DB:25.8(78.4) WB:18(64.4)		DB:27(80.6) WB:19(66.2)		DB:28.2(82.8) WB:20(68)		DB:30.7(87.3) WB:22(71.6)		DB:32(89.6) WB:24(75.2)	
		TC	PI	TC	PI	TC	PI	TC	PI	TC	PI	TC	PI	TC	PI
		kW	kW	kW	kW	kW	kW	kW	kW	kW	kW	kW	kW	kW	kW
130%	-5(23)	35.14	4.42	41.86	5.39	48.57	5.78	50.43	6.02	52.85	6.19	54.14	6.73	55.50	6.77
	-2(28.4)	35.14	4.42	41.86	5.50	48.57	5.78	50.43	6.05	52.85	6.19	54.14	6.81	55.50	6.84
	0(32)	35.14	4.49	41.86	5.59	48.57	5.99	50.43	6.38	52.85	6.55	54.14	6.90	55.50	6.93
	2(35.6)	35.14	4.58	41.86	5.61	48.57	6.20	50.43	6.74	52.85	6.62	54.14	6.95	55.50	7.03
	4(39.2)	35.14	4.68	41.86	5.71	48.57	6.41	50.43	6.77	52.85	6.71	54.14	6.94	55.50	7.17
	6(42.8)	35.14	4.77	41.86	5.83	48.57	6.65	50.43	6.83	52.26	6.92	53.48	6.94	54.89	7.22
	8(46.4)	35.14	4.88	41.86	5.96	48.57	6.98	50.43	7.16	51.62	7.14	52.90	3.90	54.19	7.29
	10(50)	35.14	4.98	41.86	6.09	48.57	7.24	50.43	7.40	51.00	4.04	52.28	4.06	53.57	7.50
	12(53.6)	35.14	5.07	41.86	6.21	48.57	7.39	49.71	4.03	50.43	4.06	51.57	4.07	52.86	7.55
	14(57.2)	35.14	5.17	41.86	6.32	48.43	4.05	49.14	4.06	49.71	4.08	51.00	4.09	52.28	7.72
	16(60.8)	35.14	5.26	41.86	6.45	47.86	4.06	48.43	4.08	49.00	4.10	50.28	4.12	51.57	7.84
	18(64.4)	35.14	5.36	41.86	6.59	47.14	7.72	47.71	7.77	48.43	7.81	49.71	7.88	51.00	7.96
	20(68)	35.14	5.48	41.86	7.01	46.43	8.10	47.14	8.14	47.71	8.19	49.00	8.26	50.28	8.35
	21(69.8)	35.14	5.62	41.86	7.26	46.14	8.29	46.85	8.33	47.43	8.38	48.71	8.47	50.00	8.54
	23(73.4)	35.14	6.03	41.86	7.78	45.57	8.67	46.14	8.71	46.71	8.76	48.00	8.84	49.28	8.93
	25(77)	35.14	6.44	41.86	8.33	44.85	9.05	45.43	9.09	46.14	9.15	47.43	9.24	48.71	9.32
	27(80.6)	35.14	6.88	41.86	8.92	44.28	9.43	44.85	9.48	45.43	9.53	46.71	9.63	48.00	9.73
	29(84.2)	35.14	7.34	41.86	9.53	43.57	9.81	44.14	9.86	44.85	9.92	46.14	10.02	47.43	10.13
	31(87.8)	35.14	7.84	41.71	10.08	42.85	10.20	43.57	10.26	44.14	10.30	45.43	10.42	46.71	10.53
	33(91.4)	35.14	8.35	41.00	10.46	42.28	10.58	42.85	10.64	43.57	10.69	44.85	10.81	46.00	10.93
35(95)	35.14	8.90	40.28	10.84	41.57	10.97	42.28	11.03	42.85	11.09	44.14	11.22	45.43	11.33	
37(98.6)	35.14	9.47	39.71	11.23	41.00	11.36	41.57	11.42	42.28	11.50	43.43	11.63	44.71	11.76	
39(102.2)	35.14	10.08	39.00	11.35	40.28	11.74	41.00	11.82	41.57	11.89	42.85	12.02	44.14	12.17	
41(105.8)	35.14	10.61	38.60	11.46	39.86	11.85	40.58	11.93	41.15	12.00	42.43	12.04	42.45	12.28	
43(109.4)	35.14	10.88	38.31	11.52	39.65	11.89	40.36	11.98	40.72	12.02	41.66	12.07	41.94	12.30	
45(113)	35.14	11.42	38.07	11.63	39.23	12.00	39.94	12.06	40.13	12.07	40.53	12.11	41.12	12.53	
48(118.4)	35.14	12.23	37.95	11.79	38.59	12.23	39.31	12.12	39.62	12.19	39.45	12.18	40.17	13.15	
120%	-5(23)	32.43	4.27	38.57	5.17	44.86	6.11	48.00	6.67	50.29	6.95	51.43	7.17	52.57	7.36
	-2(28.4)	32.43	4.31	38.57	5.22	44.86	6.17	48.00	6.71	50.29	7.03	51.43	7.23	52.57	7.39
	0(32)	32.43	4.35	38.57	5.26	44.86	6.24	48.00	6.72	50.29	7.09	51.43	7.27	52.57	7.40
	2(35.6)	32.43	4.36	38.57	5.31	44.86	6.29	48.00	6.79	50.29	7.12	51.43	7.33	52.57	7.42
	4(39.2)	32.43	4.40	38.57	5.38	44.86	6.38	48.00	6.85	50.29	7.22	51.43	7.34	52.57	7.44
	6(42.8)	32.43	4.45	38.57	5.42	44.86	6.45	48.00	6.92	50.29	7.29	51.43	7.40	52.57	7.46
	8(46.4)	32.43	4.49	38.57	5.48	44.86	6.54	48.00	7.01	50.29	7.37	51.43	7.43	52.57	7.50
	10(50)	32.43	4.55	38.57	5.55	44.86	6.60	48.00	7.14	50.29	7.37	51.43	7.45	52.57	7.53
	12(53.6)	32.43	4.63	38.57	5.65	44.86	6.73	48.00	7.27	49.57	7.40	50.71	7.41	51.86	7.58
	14(57.2)	32.43	4.72	38.57	5.77	44.86	6.86	48.00	7.42	48.86	7.45	50.14	7.52	51.28	7.67
	16(60.8)	32.43	4.81	38.57	5.89	44.86	6.99	47.71	4.10	48.28	7.56	49.43	7.65	50.57	7.79
	18(64.4)	32.43	4.90	38.57	6.00	44.86	7.23	47.00	7.72	47.57	7.75	48.72	7.82	50.00	7.90
	20(68)	32.43	5.00	38.57	6.24	44.86	7.78	46.43	8.10	47.00	8.13	48.14	8.20	49.29	8.28
	21(69.8)	32.43	5.04	38.57	6.45	44.86	8.06	46.00	8.29	46.57	8.32	47.86	8.39	49.00	8.48
	23(73.4)	32.43	5.39	38.57	6.92	44.86	8.62	45.43	8.65	46.00	8.70	47.14	8.79	48.28	8.86
	25(77)	32.43	5.76	38.57	7.40	44.14	9.00	44.71	9.03	45.28	9.08	46.57	9.16	47.71	9.25
	27(80.6)	32.43	6.15	38.57	7.91	43.57	9.37	44.14	9.43	44.71	9.47	45.86	9.56	47.00	9.64
	29(84.2)	32.43	6.56	38.57	8.45	42.86	9.75	43.43	9.80	44.00	9.85	45.14	9.95	46.43	10.04
	31(87.8)	32.43	6.99	38.57	9.02	42.14	10.14	42.86	10.18	43.43	10.24	44.57	10.34	45.71	10.45
	33(91.4)	32.43	7.44	38.57	9.62	41.57	10.52	42.14	10.58	42.71	10.62	43.86	10.74	45.00	10.84
35(95)	32.43	7.93	38.57	10.26	40.86	10.90	41.43	10.96	42.14	11.01	43.28	11.13	44.43	11.25	
37(98.6)	32.43	8.43	38.57	10.93	40.28	11.29	40.86	11.35	41.43	11.41	42.57	11.52	43.71	11.65	
39(102.2)	32.43	8.97	38.43	11.54	39.57	11.67	40.14	11.74	40.72	11.80	42.00	11.93	43.14	12.05	
41(105.8)	32.43	9.22	38.12	11.62	39.26	11.75	39.83	11.82	40.40	11.88	41.69	11.96	41.90	12.14	
43(109.4)	32.43	9.36	37.91	11.70	38.95	11.82	39.52	11.87	40.09	11.93	40.96	12.00	41.25	12.38	
45(113)	32.43	9.47	37.71	11.81	38.58	11.93	39.11	11.98	39.74	12.02	40.14	12.04	40.84	12.65	
48(118.4)	32.43	9.63	37.39	11.98	38.08	12.08	38.49	12.13	39.31	12.25	39.51	12.26	40.30	12.82	

**Cooling capacity table**

**MVD-V5X400W/V2GN1**

TC: Total Capacity (kW); PI: Power Input (kW) (Compressor + Outdoor fan motor)

Combination (%)	Outdoor temperature (°C(°F) DB)	Indoor temperature(°C(°F))													
		DB:20.8(69.4) WB:14(57.2)		DB:23.3(73.9) WB:16(60.8)		DB:25.8(78.4) WB:18(64.4)		DB:27(80.6) WB:19(66.2)		DB:28.2(82.8) WB:20(68)		DB:30.7(87.3) WB:22(71.6)		DB:32(89.6) WB:24(75.2)	
		TC	PI	TC	PI	TC	PI	TC	PI	TC	PI	TC	PI	TC	PI
		kW	kW	kW	kW	kW	kW	kW	kW	kW	kW	kW	kW	kW	kW
110%	-5(23)	29.71	3.73	35.43	4.64	41.14	5.54	44.00	5.94	46.86	6.39	50.43	6.64	51.57	6.85
	-2(28.4)	29.71	3.80	35.43	4.70	41.14	5.58	44.00	6.00	46.86	6.44	50.43	6.71	51.57	6.88
	0(32)	29.71	3.84	35.43	4.73	41.14	5.63	44.00	6.04	46.86	6.52	50.43	6.77	51.57	6.97
	2(35.6)	29.71	3.92	35.43	4.77	41.14	5.71	44.00	6.11	46.86	6.59	50.43	6.87	51.57	7.05
	4(39.2)	29.71	4.00	35.43	4.83	41.14	5.77	44.00	6.18	46.86	6.69	50.43	6.97	51.57	7.12
	6(42.8)	29.71	4.04	35.43	4.88	41.14	5.82	44.00	6.28	46.86	6.76	50.43	7.04	51.57	7.23
	8(46.4)	29.71	4.07	35.43	4.96	41.14	5.89	44.00	6.35	46.86	6.84	50.43	7.09	51.57	7.30
	10(50)	29.71	4.12	35.43	5.03	41.14	5.97	44.00	6.45	46.86	6.95	50.43	7.14	51.57	7.37
	12(53.6)	29.71	4.21	35.43	5.13	41.14	6.09	44.00	6.59	46.86	7.08	49.86	7.24	50.86	7.46
	14(57.2)	29.71	4.28	35.43	5.22	41.14	6.21	44.00	6.70	46.86	7.21	49.14	7.30	50.29	7.52
	16(60.8)	29.71	4.36	35.43	5.32	41.14	6.32	44.00	6.83	46.86	7.36	48.57	7.39	49.57	7.60
	18(64.4)	29.71	4.44	35.43	5.42	41.14	6.45	44.00	7.02	46.86	7.71	47.86	7.77	49.00	7.84
	20(68)	29.71	4.53	35.43	5.54	41.14	6.83	44.00	7.55	46.14	8.09	47.29	8.14	48.29	8.22
	21(69.8)	29.71	4.57	35.43	5.70	41.14	7.08	44.00	7.82	45.86	8.28	46.86	8.33	48.00	8.41
	23(73.4)	29.71	4.79	35.43	6.10	41.14	7.59	44.00	8.39	45.15	8.64	46.29	8.73	47.29	8.80
	25(77)	29.71	5.11	35.43	6.53	41.14	8.11	44.00	8.99	44.57	9.02	45.57	9.11	46.71	9.18
	27(80.6)	29.71	5.45	35.43	6.98	41.14	8.68	43.29	9.37	43.86	9.40	45.00	9.48	46.00	9.57
	29(84.2)	29.71	5.81	35.43	7.45	41.14	9.28	42.72	9.75	43.29	9.79	44.29	9.88	45.43	9.97
	31(87.8)	29.71	6.19	35.43	7.94	41.14	9.91	42.00	10.13	42.57	10.17	43.72	10.26	44.71	10.36
	33(91.4)	29.71	6.59	35.43	8.47	40.86	10.45	41.43	10.50	42.00	10.55	43.00	10.65	44.14	10.75
35(95)	29.71	7.01	35.43	9.02	40.15	10.82	40.72	10.88	41.29	10.94	42.29	11.04	43.43	11.15	
37(98.6)	29.71	7.46	35.43	9.60	39.57	11.22	40.15	11.26	40.57	11.32	41.72	11.44	42.72	11.54	
39(102.2)	29.71	7.93	35.43	10.23	38.86	11.60	39.43	11.66	40.00	11.71	41.00	11.83	42.15	11.95	
41(105.8)	29.71	8.01	35.43	10.31	38.55	11.68	39.12	11.74	39.70	11.80	40.48	11.91	40.88	12.03	
43(109.4)	29.71	8.09	35.43	10.44	38.25	11.76	38.82	11.82	39.39	11.88	40.12	11.96	40.25	12.27	
45(113)	29.71	8.35	35.43	10.50	37.86	11.87	38.41	11.96	39.04	11.99	39.71	12.28	39.87	12.56	
48(118.4)	29.71	8.56	35.43	10.66	37.31	12.03	37.80	12.15	38.60	12.22	39.06	12.76	39.36	13.21	
100%	-5(23)	27.00	3.39	32.14	4.09	37.43	4.86	40.00	5.21	42.57	5.65	47.86	6.44	50.57	6.72
	-2(28.4)	27.00	3.44	32.14	4.14	37.43	4.92	40.00	5.31	42.57	5.73	47.86	6.52	50.57	6.77
	0(32)	27.00	3.47	32.14	4.18	37.43	4.97	40.00	5.37	42.57	5.78	47.86	6.63	50.57	6.84
	2(35.6)	27.00	3.54	32.14	4.24	37.43	5.03	40.00	5.44	42.57	5.85	47.86	6.72	50.57	6.95
	4(39.2)	27.00	3.57	32.14	4.28	37.43	5.10	40.00	5.52	42.57	5.92	47.86	6.79	50.57	7.03
	6(42.8)	27.00	3.62	32.14	4.37	37.43	5.17	40.00	5.62	42.57	6.01	47.86	6.89	50.57	7.13
	8(46.4)	27.00	3.69	32.14	4.43	37.43	5.26	40.00	5.69	42.57	6.11	47.86	6.99	50.57	7.25
	10(50)	27.00	3.73	32.14	4.52	37.43	5.35	40.00	5.78	42.57	6.22	47.86	7.11	50.57	7.36
	12(53.6)	27.00	3.79	32.14	4.60	37.43	5.45	40.00	5.89	42.57	6.34	47.86	7.24	49.86	7.41
	14(57.2)	27.00	3.86	32.14	4.69	37.43	5.55	40.00	6.00	42.57	6.45	47.86	7.39	49.28	7.50
	16(60.8)	27.00	3.93	32.14	4.78	37.43	5.67	40.00	6.12	42.57	6.59	47.57	7.47	48.57	7.59
	18(64.4)	27.00	4.01	32.14	4.87	37.43	5.77	40.00	6.24	42.57	6.72	47.00	7.72	48.00	7.78
	20(68)	27.00	4.08	32.14	4.97	37.43	5.94	40.00	6.56	42.57	7.20	46.28	8.09	47.28	8.16
	21(69.8)	27.00	4.12	32.14	5.01	37.43	6.16	40.00	6.79	42.57	7.44	46.00	8.28	47.00	8.35
	23(73.4)	27.00	4.22	32.14	5.35	37.43	6.60	40.00	7.27	42.57	7.98	45.43	8.65	46.28	8.73
	25(77)	27.00	4.50	32.14	5.71	37.43	7.07	40.00	7.79	42.57	8.55	44.72	9.03	45.71	9.11
	27(80.6)	27.00	4.81	32.14	6.09	37.43	7.55	40.00	8.33	42.57	9.15	44.00	9.41	45.00	9.50
	29(84.2)	27.00	5.11	32.14	6.50	37.43	8.06	40.00	8.90	42.43	9.72	43.43	9.80	44.43	9.88
	31(87.8)	27.00	5.45	32.14	6.93	37.43	8.60	40.00	9.50	41.86	10.10	42.72	10.18	43.71	10.27
	33(91.4)	27.00	5.78	32.14	7.39	37.43	9.16	40.00	10.14	41.14	10.47	42.14	10.56	43.14	10.66
35(95)	27.00	6.15	32.14	7.85	37.43	9.78	40.00	10.81	40.43	10.85	41.43	10.95	42.43	11.04	
37(98.6)	27.00	6.54	32.14	8.36	37.43	10.42	39.28	11.19	39.86	11.25	40.86	11.35	41.72	11.44	
39(102.2)	27.00	6.95	32.14	8.89	37.43	11.09	38.71	11.57	39.14	11.63	40.14	11.73	41.14	11.84	
41(105.8)	27.00	7.27	32.14	9.21	37.43	11.49	38.11	11.65	38.84	11.80	39.68	12.00	40.54	12.09	
43(109.4)	27.00	7.60	32.14	9.54	37.43	11.71	37.51	11.78	38.56	11.92	39.44	12.08	39.83	12.22	
45(113)	27.00	8.03	32.14	9.97	37.43	11.90	37.48	11.95	38.36	12.13	39.03	12.27	39.35	12.39	
48(118.4)	27.00	8.68	32.14	10.62	37.43	12.11	37.45	12.27	38.30	12.59	38.71	12.62	39.11	12.71	

**Cooling capacity table**

**MVD-V5X400W/V2GN1**

TC: Total Capacity (kW); PI: Power Input (kW) (Compressor + Outdoor fan motor)

Combination (%)	Outdoor temperature (°C(°F) DB)	Indoor temperature(°C(°F))													
		DB:20.8(69.4) WB:14(57.2)		DB:23.3(73.9) WB:16(60.8)		DB:25.8(78.4) WB:18(64.4)		DB:27(80.6) WB:19(66.2)		DB:28.2(82.8) WB:20(68)		DB:30.7(87.3) WB:22(71.6)		DB:32(89.6) WB:24(75.2)	
		TC	PI	TC	PI	TC	PI	TC	PI	TC	PI	TC	PI	TC	PI
		kW	kW	kW	kW	kW	kW	kW	kW	kW	kW	kW	kW	kW	kW
90%	-5(23)	24.29	3.00	29.00	3.60	33.71	4.25	36.00	4.64	38.29	4.93	43.00	5.67	47.71	6.49
	-2(28.4)	24.29	3.03	29.00	3.64	33.71	4.30	36.00	4.70	38.29	4.99	43.00	5.73	47.71	6.56
	0(32)	24.29	3.08	29.00	3.69	33.71	4.37	36.00	4.76	38.29	5.06	43.00	5.79	47.71	6.61
	2(35.6)	24.29	3.12	29.00	3.73	33.71	4.41	36.00	4.83	38.29	5.14	43.00	5.91	47.71	6.71
	4(39.2)	24.29	3.17	29.00	3.79	33.71	4.49	36.00	4.90	38.29	5.20	43.00	6.00	47.71	6.80
	6(42.8)	24.29	3.21	29.00	3.86	33.71	4.57	36.00	4.99	38.29	5.29	43.00	6.10	47.71	6.92
	8(46.4)	24.29	3.27	29.00	3.93	33.71	4.67	36.00	5.05	38.29	5.38	43.00	6.21	47.71	6.98
	10(50)	24.29	3.34	29.00	4.02	33.71	4.75	36.00	5.13	38.29	5.51	43.00	6.29	47.71	7.09
	12(53.6)	24.29	3.39	29.00	4.09	33.71	4.84	36.00	5.21	38.29	5.61	43.00	6.41	47.71	7.23
	14(57.2)	24.29	3.45	29.00	4.17	33.71	4.92	36.00	5.32	38.29	5.71	43.00	6.53	47.71	7.36
	16(60.8)	24.29	3.51	29.00	4.24	33.71	5.03	36.00	5.42	38.29	5.83	43.00	6.66	47.57	7.49
	18(64.4)	24.29	3.57	29.00	4.33	33.71	5.11	36.00	5.52	38.29	5.94	43.00	6.79	47.00	7.72
	20(68)	24.29	3.64	29.00	4.43	33.71	5.22	36.00	5.64	38.29	6.16	43.00	7.30	46.29	8.09
	21(69.8)	24.29	3.67	29.00	4.46	33.71	5.30	36.00	5.83	38.29	6.38	43.00	7.56	46.00	8.27
	23(73.4)	24.29	3.74	29.00	4.63	33.71	5.68	36.00	6.25	38.29	6.85	43.00	8.11	45.28	8.65
	25(77)	24.29	3.95	29.00	4.95	33.71	6.07	36.00	6.69	38.29	7.31	43.00	8.68	44.72	9.03
	27(80.6)	24.29	4.20	29.00	5.27	33.71	6.48	36.00	7.14	38.29	7.82	43.00	9.29	44.00	9.41
	29(84.2)	24.29	4.47	29.00	5.62	33.71	6.92	36.00	7.62	38.29	8.36	42.57	9.72	43.43	9.79
	31(87.8)	24.29	4.75	29.00	5.99	33.71	7.37	36.00	8.13	38.29	8.92	41.86	10.10	42.71	10.18
	33(91.4)	24.29	5.04	29.00	6.37	33.71	7.87	36.00	8.67	38.29	9.51	41.28	10.49	42.14	10.56
35(95)	24.29	5.36	29.00	6.77	33.71	8.38	36.00	9.24	38.29	10.14	40.57	10.87	41.43	10.95	
37(98.6)	24.29	5.68	29.00	7.20	33.71	8.92	36.00	9.83	38.29	10.81	39.86	11.25	40.86	11.33	
39(102.2)	24.29	6.03	29.00	7.66	33.71	9.48	36.00	10.47	38.29	11.51	39.29	11.64	40.14	11.73	
41(105.8)	24.29	6.24	29.00	8.01	33.71	9.83	36.00	10.75	38.29	11.58	39.01	11.94	39.87	12.00	
43(109.4)	24.29	6.54	29.00	8.36	33.71	10.18	36.00	11.03	38.29	11.83	38.81	12.09	39.53	12.19	
45(113)	24.29	6.95	29.00	8.77	33.71	10.59	36.00	11.40	38.29	12.15	38.60	12.22	38.93	12.35	
48(118.4)	24.29	7.51	29.00	9.33	33.71	11.15	36.00	11.95	38.29	12.43	38.45	12.46	38.63	12.56	
80%	-5(23)	21.57	2.65	25.72	3.13	29.86	3.70	32.00	3.94	34.14	4.24	38.28	4.90	42.43	5.59
	-2(28.4)	21.57	2.68	25.72	3.17	29.86	3.73	32.00	4.00	34.14	4.28	38.28	4.95	42.43	5.65
	0(32)	21.57	2.73	25.72	3.21	29.86	3.78	32.00	4.05	34.14	4.36	38.28	5.02	42.43	5.73
	2(35.6)	21.57	2.79	25.72	3.25	29.86	3.84	32.00	4.12	34.14	4.43	38.28	5.12	42.43	5.83
	4(39.2)	21.57	2.83	25.72	3.31	29.86	3.91	32.00	4.22	34.14	4.51	38.28	5.21	42.43	5.91
	6(42.8)	21.57	2.88	25.72	3.38	29.86	3.97	32.00	4.31	34.14	4.60	38.28	5.29	42.43	6.01
	8(46.4)	21.57	2.93	25.72	3.46	29.86	4.06	32.00	4.38	34.14	4.70	38.28	5.37	42.43	6.13
	10(50)	21.57	2.96	25.72	3.54	29.86	4.17	32.00	4.49	34.14	4.81	38.28	5.49	42.43	6.19
	12(53.6)	21.57	3.00	25.72	3.60	29.86	4.24	32.00	4.57	34.14	4.91	38.28	5.59	42.43	6.31
	14(57.2)	21.57	3.06	25.72	3.67	29.86	4.31	32.00	4.65	34.14	5.00	38.28	5.70	42.43	6.42
	16(60.8)	21.57	3.10	25.72	3.73	29.86	4.40	32.00	4.73	34.14	5.08	38.28	5.81	42.43	6.54
	18(64.4)	21.57	3.16	25.72	3.80	29.86	4.49	32.00	4.84	34.14	5.19	38.28	5.93	42.43	6.67
	20(68)	21.57	3.22	25.72	3.88	29.86	4.57	32.00	4.92	34.14	5.29	38.28	6.15	42.43	7.14
	21(69.8)	21.57	3.25	25.72	3.90	29.86	4.62	32.00	4.98	34.14	5.41	38.28	6.37	42.43	7.40
	23(73.4)	21.57	3.31	25.72	3.99	29.86	4.84	32.00	5.30	34.14	5.78	38.28	6.82	42.43	7.94
	25(77)	21.57	3.41	25.72	4.24	29.86	5.17	32.00	5.67	34.14	6.18	38.28	7.30	42.43	8.49
	27(80.6)	21.57	3.63	25.72	4.52	29.86	5.51	32.00	6.05	34.14	6.60	38.28	7.79	42.43	9.09
	29(84.2)	21.57	3.86	25.72	4.81	29.86	5.87	32.00	6.44	34.14	7.05	38.28	8.32	42.43	9.72
	31(87.8)	21.57	4.09	25.72	5.11	29.86	6.25	32.00	6.86	34.14	7.52	38.28	8.89	41.72	10.10
	33(91.4)	21.57	4.36	25.72	5.43	29.86	6.66	32.00	7.31	34.14	8.00	38.28	9.47	41.14	10.47
35(95)	21.57	4.62	25.72	5.78	29.86	7.08	32.00	7.78	34.14	8.52	38.28	10.10	40.43	10.85	
37(98.6)	21.57	4.90	25.72	6.13	29.86	7.53	32.00	8.29	34.14	9.08	38.28	10.77	39.86	11.23	
39(102.2)	21.57	5.19	25.72	6.54	29.86	8.01	32.00	8.81	34.14	9.66	38.28	11.47	39.14	11.63	
41(105.8)	21.57	5.30	25.72	6.60	29.86	8.13	32.00	9.05	34.14	9.83	38.28	11.76	38.90	11.83	
43(109.4)	21.57	5.46	25.72	6.66	29.86	8.25	32.00	9.20	34.14	9.97	38.28	11.89	38.66	11.96	
45(113)	21.57	5.61	25.72	6.74	29.86	8.41	32.00	9.40	34.14	10.14	38.28	12.02	38.18	12.15	
48(118.4)	21.57	5.73	25.72	6.85	29.86	8.65	32.00	9.75	34.14	10.43	38.28	12.30	37.86	12.57	

**Cooling capacity table**

**MVD-V5X400W/V2GN1**

TC: Total Capacity (kW); PI: Power Input (kW) (Compressor + Outdoor fan motor)

Combination (%)	Outdoor temperature (°C(°F) DB)	Indoor temperature(°C(°F))													
		DB:20.8(69.4) WB:14(57.2)		DB:23.3(73.9) WB:16(60.8)		DB:25.8(78.4) WB:18(64.4)		DB:27(80.6) WB:19(66.2)		DB:28.2(82.8) WB:20(68)		DB:30.7(87.3) WB:22(71.6)		DB:32(89.6) WB:24(75.2)	
		TC	PI	TC	PI	TC	PI	TC	PI	TC	PI	TC	PI	TC	PI
		kW	kW	kW	kW	kW	kW	kW	kW	kW	kW	kW	kW	kW	kW
70%	-5(23)	18.86	2.36	22.57	2.77	26.14	3.14	28.00	3.36	29.86	3.59	33.43	4.11	37.14	4.72
	-2(28.4)	18.86	2.38	22.57	2.78	26.14	3.16	28.00	3.43	29.86	3.65	33.43	4.17	37.14	4.79
	0(32)	18.86	2.39	22.57	2.82	26.14	3.22	28.00	3.49	29.86	3.72	33.43	4.26	37.14	4.85
	2(35.6)	18.86	2.41	22.57	2.83	26.14	3.27	28.00	3.56	29.86	3.78	33.43	4.35	37.14	4.93
	4(39.2)	18.86	2.44	22.57	2.90	26.14	3.35	28.00	3.62	29.86	3.87	33.43	4.42	37.14	5.05
	6(42.8)	18.86	2.48	22.57	2.95	26.14	3.43	28.00	3.74	29.86	3.96	33.43	4.50	37.14	5.14
	8(46.4)	18.86	2.52	22.57	3.04	26.14	3.51	28.00	3.80	29.86	4.04	33.43	4.63	37.14	5.24
	10(50)	18.86	2.57	22.57	3.09	26.14	3.60	28.00	3.88	29.86	4.15	33.43	4.72	37.14	5.30
	12(53.6)	18.86	2.64	22.57	3.13	26.14	3.67	28.00	3.95	29.86	4.23	33.43	4.81	37.14	5.41
	14(57.2)	18.86	2.68	22.57	3.19	26.14	3.73	28.00	4.01	29.86	4.30	33.43	4.90	37.14	5.51
	16(60.8)	18.86	2.72	22.57	3.25	26.14	3.80	28.00	4.09	29.86	4.39	33.43	4.98	37.14	5.61
	18(64.4)	18.86	2.77	22.57	3.31	26.14	3.88	28.00	4.17	29.86	4.46	33.43	5.08	37.14	5.73
	20(68)	18.86	2.81	22.57	3.37	26.14	3.95	28.00	4.24	29.86	4.55	33.43	5.19	37.14	5.89
	21(69.8)	18.86	2.84	22.57	3.39	26.14	3.98	28.00	4.28	29.86	4.59	33.43	5.26	37.14	6.09
	23(73.4)	18.86	2.88	22.57	3.45	26.14	4.06	28.00	4.43	29.86	4.82	33.43	5.64	37.14	6.53
	25(77)	18.86	2.94	22.57	3.60	26.14	4.33	28.00	4.74	29.86	5.14	33.43	6.03	37.14	6.98
	27(80.6)	18.86	3.12	22.57	3.83	26.14	4.62	28.00	5.04	29.86	5.49	33.43	6.44	37.14	7.46
	29(84.2)	18.86	3.31	22.57	4.06	26.14	4.91	28.00	5.38	29.86	5.84	33.43	6.86	37.14	7.97
	31(87.8)	18.86	3.50	22.57	4.31	26.14	5.23	28.00	5.71	29.86	6.22	33.43	7.31	37.14	8.49
	33(91.4)	18.86	3.71	22.57	4.59	26.14	5.57	28.00	6.08	29.86	6.63	33.43	7.79	37.14	9.06
35(95)	18.86	3.93	22.57	4.87	26.14	5.90	28.00	6.47	29.86	7.05	33.43	8.30	37.14	9.66	
37(98.6)	18.86	4.15	22.57	5.16	26.14	6.28	28.00	6.86	29.86	7.50	33.43	8.84	37.14	10.29	
39(102.2)	18.86	4.40	22.57	5.46	26.14	6.66	28.00	7.30	29.86	7.97	33.43	9.40	37.14	10.96	
41(105.8)	18.86	4.59	22.57	5.66	26.14	6.85	28.00	7.54	29.86	8.21	33.43	9.79	37.14	11.44	
43(109.4)	18.86	4.97	22.57	6.05	26.14	7.13	28.00	7.95	29.86	8.45	33.43	10.14	37.14	11.80	
45(113)	18.86	5.08	22.57	6.18	26.14	7.28	28.00	8.08	29.86	8.88	33.43	10.69	37.14	12.25	
48(118.4)	18.86	5.41	22.57	6.56	26.14	7.73	28.00	8.46	29.86	9.13	33.43	11.01	37.14	12.51	
60%	-5(23)	16.14	2.01	19.29	2.34	22.43	2.72	24.00	2.90	25.57	3.13	28.71	3.52	31.86	4.03
	-2(28.4)	16.14	2.02	19.29	2.37	22.43	2.77	24.00	2.94	25.57	3.16	28.71	3.57	31.86	4.06
	0(32)	16.14	2.06	19.29	2.40	22.43	2.81	24.00	2.98	25.57	3.22	28.71	3.62	31.86	4.11
	2(35.6)	16.14	2.09	19.29	2.46	22.43	2.86	24.00	3.04	25.57	3.26	28.71	3.70	31.86	4.17
	4(39.2)	16.14	2.15	19.29	2.50	22.43	2.92	24.00	3.07	25.57	3.31	28.71	3.75	31.86	4.22
	6(42.8)	16.14	2.17	19.29	2.55	22.43	2.97	24.00	3.14	25.57	3.37	28.71	3.83	31.86	4.32
	8(46.4)	16.14	2.21	19.29	2.59	22.43	3.03	24.00	3.20	25.57	3.44	28.71	3.90	31.86	4.39
	10(50)	16.14	2.26	19.29	2.65	22.43	3.07	24.00	3.29	25.57	3.51	28.71	3.98	31.86	4.46
	12(53.6)	16.14	2.30	19.29	2.69	22.43	3.13	24.00	3.35	25.57	3.57	28.71	4.05	31.86	4.53
	14(57.2)	16.14	2.33	19.29	2.74	22.43	3.18	24.00	3.41	25.57	3.64	28.71	4.12	31.86	4.62
	16(60.8)	16.14	2.36	19.29	2.78	22.43	3.23	24.00	3.47	25.57	3.70	28.71	4.20	31.86	4.71
	18(64.4)	16.14	2.40	19.29	2.83	22.43	3.29	24.00	3.53	25.57	3.77	28.71	4.27	31.86	4.79
	20(68)	16.14	2.43	19.29	2.88	22.43	3.35	24.00	3.60	25.57	3.85	28.71	4.36	31.86	4.89
	21(69.8)	16.14	2.46	19.29	2.90	22.43	3.38	24.00	3.63	25.57	3.87	28.71	4.40	31.86	4.94
	23(73.4)	16.14	2.49	19.29	2.96	22.43	3.44	24.00	3.70	25.57	3.95	28.71	4.57	31.86	5.26
	25(77)	16.14	2.53	19.29	3.00	22.43	3.57	24.00	3.87	25.57	4.20	28.71	4.88	31.86	5.61
	27(80.6)	16.14	2.64	19.29	3.19	22.43	3.80	24.00	4.14	25.57	4.47	28.71	5.20	31.86	5.99
	29(84.2)	16.14	2.78	19.29	3.38	22.43	4.05	24.00	4.40	25.57	4.76	28.71	5.55	31.86	6.39
	31(87.8)	16.14	2.96	19.29	3.58	22.43	4.30	24.00	4.68	25.57	5.07	28.71	5.90	31.86	6.80
	33(91.4)	16.14	3.12	19.29	3.80	22.43	4.56	24.00	4.97	25.57	5.39	28.71	6.28	31.86	7.25
35(95)	16.14	3.31	19.29	4.03	22.43	4.84	24.00	5.27	25.57	5.72	28.71	6.69	31.86	7.72	
37(98.6)	16.14	3.50	19.29	4.27	22.43	5.13	24.00	5.59	25.57	6.07	28.71	7.11	31.86	8.22	
39(102.2)	16.14	3.69	19.29	4.52	22.43	5.43	24.00	5.93	25.57	6.45	28.71	7.55	31.86	8.74	
41(105.8)	16.14	3.80	19.29	4.71	22.43	5.63	24.00	6.17	25.57	6.69	28.71	7.90	31.86	9.14	
43(109.4)	16.14	3.92	19.29	4.91	22.43	5.83	24.00	6.35	25.57	6.92	28.71	8.24	31.86	9.53	
45(113)	16.14	4.11	19.29	5.16	22.43	6.07	24.00	6.59	25.57	7.27	28.71	8.61	31.86	10.06	
48(118.4)	16.14	4.42	19.29	5.50	22.43	6.38	24.00	6.98	25.57	7.83	28.71	9.06	31.86	10.85	



**Cooling capacity table**

**MVD-V5X400W/V2GN1**

TC: Total Capacity (kW); PI: Power Input (kW) (Compressor + Outdoor fan motor)

Combination (%)	Outdoor temperature (°C(°F) DB)	Indoor temperature(°C(°F))													
		DB:20.8(69.4) WB:14(57.2)		DB:23.3(73.9) WB:16(60.8)		DB:25.8(78.4) WB:18(64.4)		DB:27(80.6) WB:19(66.2)		DB:28.2(82.8) WB:20(68)		DB:30.7(87.3) WB:22(71.6)		DB:32(89.6) WB:24(75.2)	
		TC	PI	TC	PI	TC	PI	TC	PI	TC	PI	TC	PI	TC	PI
		kW	kW	kW	kW	kW	kW	kW	kW	kW	kW	kW	kW	kW	kW
50%	-5(23)	13.50	1.75	16.14	2.02	18.71	2.32	20.00	2.43	21.29	2.57	23.86	2.92	26.57	3.15
	-2(28.4)	13.50	1.76	16.14	2.06	18.71	2.35	20.00	2.47	21.29	2.61	23.86	2.96	26.57	3.19
	0(32)	13.50	1.79	16.14	2.10	18.71	2.39	20.00	2.50	21.29	2.64	23.86	3.01	26.57	3.24
	2(35.6)	13.50	1.82	16.14	2.12	18.71	2.43	20.00	2.54	21.29	2.69	23.86	3.02	26.57	3.31
	4(39.2)	13.50	1.83	16.14	2.16	18.71	2.46	20.00	2.57	21.29	2.74	23.86	3.10	26.57	3.39
	6(42.8)	13.50	1.87	16.14	2.19	18.71	2.50	20.00	2.63	21.29	2.79	23.86	3.14	26.57	3.49
	8(46.4)	13.50	1.91	16.14	2.23	18.71	2.54	20.00	2.69	21.29	2.83	23.86	3.19	26.57	3.60
	10(50)	13.50	1.95	16.14	2.26	18.71	2.58	20.00	2.73	21.29	2.91	23.86	3.28	26.57	3.66
	12(53.6)	13.50	1.97	16.14	2.29	18.71	2.62	20.00	2.78	21.29	2.97	23.86	3.34	26.57	3.71
	14(57.2)	13.50	2.00	16.14	2.32	18.71	2.65	20.00	2.84	21.29	3.02	23.86	3.39	26.57	3.79
	16(60.8)	13.50	2.02	16.14	2.35	18.71	2.70	20.00	2.88	21.29	3.06	23.86	3.45	26.57	3.85
	18(64.4)	13.50	2.05	16.14	2.39	18.71	2.74	20.00	2.93	21.29	3.12	23.86	3.51	26.57	3.92
	20(68)	13.50	2.08	16.14	2.42	18.71	2.78	20.00	2.97	21.29	3.18	23.86	3.57	26.57	3.99
	21(69.8)	13.50	2.10	16.14	2.45	18.71	2.81	20.00	3.00	21.29	3.20	23.86	3.61	26.57	4.04
	23(73.4)	13.50	2.13	16.14	2.48	18.71	2.86	20.00	3.06	21.29	3.26	23.86	3.67	26.57	4.12
	25(77)	13.50	2.16	16.14	2.52	18.71	2.91	20.00	3.12	21.29	3.37	23.86	3.86	26.57	4.40
	27(80.6)	13.50	2.20	16.14	2.62	18.71	3.07	20.00	3.32	21.29	3.57	23.86	4.11	26.57	4.69
	29(84.2)	13.50	2.32	16.14	2.77	18.71	3.26	20.00	3.53	21.29	3.80	23.86	4.37	26.57	5.00
	31(87.8)	13.50	2.45	16.14	2.93	18.71	3.45	20.00	3.74	21.29	4.04	23.86	4.65	26.57	5.32
	33(91.4)	13.50	2.59	16.14	3.10	18.71	3.67	20.00	3.96	21.29	4.28	23.86	4.94	26.57	5.65
35(95)	13.50	2.74	16.14	3.28	18.71	3.87	20.00	4.20	21.29	4.53	23.86	5.24	26.57	6.00	
37(98.6)	13.50	2.88	16.14	3.47	18.71	4.11	20.00	4.44	21.29	4.81	23.86	5.56	26.57	6.38	
39(102.2)	13.50	3.04	16.14	3.66	18.71	4.34	20.00	4.71	21.29	5.10	23.86	5.90	26.57	6.77	
41(105.8)	13.50	3.17	16.14	3.81	18.71	4.50	20.00	4.93	21.29	5.32	23.86	6.21	26.57	7.09	
43(109.4)	13.50	3.38	16.14	4.08	18.71	4.66	20.00	5.15	21.29	5.46	23.86	6.53	26.57	7.40	
45(113)	13.50	3.46	16.14	4.18	18.71	4.97	20.00	5.54	21.29	5.69	23.86	7.16	26.57	8.03	
48(118.4)	13.50	3.69	16.14	4.50	18.71	5.18	20.00	5.80	21.29	5.85	23.86	7.58	26.57	8.45	

**Cooling capacity table**

**MVD-V5X450W/V2GN1**

TC: Total Capacity (kW); PI: Power Input (kW) (Compressor + Outdoor fan motor)

Combination (%)	Outdoor temperature (°C(°F) DB)	Indoor temperature(°C(°F))													
		DB:20.8(69.4) WB:14(57.2)		DB:23.3(73.9) WB:16(60.8)		DB:25.8(78.4) WB:18(64.4)		DB:27(80.6) WB:19(66.2)		DB:28.2(82.8) WB:20(68)		DB:30.7(87.3) WB:22(71.6)		DB:32(89.6) WB:24(75.2)	
		TC	PI	TC	PI	TC	PI	TC	PI	TC	PI	TC	PI	TC	PI
		kW	kW	kW	kW	kW	kW	kW	kW	kW	kW	kW	kW	kW	kW
130%	-5(23)	39.54	5.24	47.09	6.40	54.64	6.86	56.73	7.14	59.46	7.34	60.91	7.99	62.44	8.04
	-2(28.4)	39.54	5.24	47.09	6.53	54.64	6.86	56.73	7.18	59.46	7.34	60.91	8.09	62.44	8.12
	0(32)	39.54	5.33	47.09	6.64	54.64	7.11	56.73	7.58	59.46	7.77	60.91	8.19	62.44	8.22
	2(35.6)	39.54	5.43	47.09	6.65	54.64	7.36	56.73	8.00	59.46	7.86	60.91	8.25	62.44	8.35
	4(39.2)	39.54	5.55	47.09	6.78	54.64	7.61	56.73	8.04	59.46	7.96	60.91	8.24	62.44	8.51
	6(42.8)	39.54	5.66	47.09	6.92	54.64	7.89	56.73	8.10	58.80	8.21	60.16	8.24	61.75	8.57
	8(46.4)	39.54	5.79	47.09	7.08	54.64	8.29	56.73	8.50	58.07	8.48	59.51	3.90	60.97	8.65
	10(50)	39.54	5.91	47.09	7.23	54.64	8.59	56.73	8.79	57.37	4.04	58.82	4.06	60.27	8.90
	12(53.6)	39.54	6.02	47.09	7.37	54.64	8.77	55.93	4.03	56.73	4.06	58.02	4.07	59.46	8.96
	14(57.2)	39.54	6.14	47.09	7.50	54.48	4.05	55.29	4.06	55.93	4.08	57.37	4.09	58.82	9.16
	16(60.8)	39.54	6.24	47.09	7.66	53.84	4.06	54.48	4.08	55.12	4.10	56.57	4.12	58.02	9.30
	18(64.4)	39.54	6.36	47.09	7.82	53.04	9.16	53.68	9.22	54.48	9.27	55.93	9.36	57.37	9.44
	20(68)	39.54	6.50	47.09	8.32	52.23	9.61	53.04	9.67	53.68	9.72	55.12	9.80	56.57	9.91
	21(69.8)	39.54	6.67	47.09	8.61	51.91	9.84	52.71	9.89	53.35	9.94	54.80	10.05	56.25	10.13
	23(73.4)	39.54	7.16	47.09	9.23	51.27	10.29	51.91	10.34	52.55	10.39	54.00	10.50	55.44	10.60
	25(77)	39.54	7.64	47.09	9.89	50.46	10.74	51.10	10.79	51.91	10.86	53.35	10.96	54.80	11.07
	27(80.6)	39.54	8.16	47.09	10.58	49.82	11.19	50.46	11.26	51.10	11.31	52.55	11.43	54.00	11.55
	29(84.2)	39.54	8.72	47.09	11.31	49.02	11.64	49.66	11.71	50.46	11.78	51.91	11.90	53.35	12.02
	31(87.8)	39.54	9.30	46.93	11.97	48.21	12.10	49.02	12.17	49.66	12.23	51.10	12.36	52.55	12.50
	33(91.4)	39.54	9.91	46.12	12.42	47.57	12.55	48.21	12.62	49.02	12.69	50.46	12.83	51.75	12.97
35(95)	39.54	10.57	45.32	12.87	46.77	13.02	47.57	13.09	48.21	13.16	49.66	13.32	51.10	13.45	
37(98.6)	39.54	11.24	44.68	13.33	46.12	13.49	46.77	13.56	47.57	13.64	48.85	13.80	50.30	13.96	
39(102.2)	39.54	11.97	43.87	13.47	45.32	13.94	46.12	14.02	46.77	14.11	48.21	14.27	49.66	14.44	
41(105.8)	39.54	12.59	43.42	13.60	44.84	14.07	45.65	14.15	46.29	14.24	47.74	14.29	47.76	14.57	
43(109.4)	39.54	12.91	43.10	13.67	44.61	14.11	45.41	14.22	45.81	14.26	46.87	14.32	47.19	14.60	
45(113)	39.54	13.56	42.83	13.80	44.13	14.24	44.93	14.31	45.15	14.33	45.60	14.37	46.26	14.88	
48(118.4)	39.54	14.52	42.69	13.99	43.42	14.51	44.22	14.39	44.58	14.46	44.38	14.45	45.19	15.60	
120%	-5(23)	36.48	5.07	43.39	6.13	50.47	7.26	54.00	7.91	56.57	8.25	57.86	8.51	59.14	8.74
	-2(28.4)	36.48	5.12	43.39	6.20	50.47	7.33	54.00	7.96	56.57	8.35	57.86	8.58	59.14	8.77
	0(32)	36.48	5.16	43.39	6.24	50.47	7.41	54.00	7.98	56.57	8.42	57.86	8.63	59.14	8.79
	2(35.6)	36.48	5.18	43.39	6.31	50.47	7.46	54.00	8.05	56.57	8.45	57.86	8.70	59.14	8.80
	4(39.2)	36.48	5.23	43.39	6.39	50.47	7.57	54.00	8.13	56.57	8.57	57.86	8.72	59.14	8.83
	6(42.8)	36.48	5.28	43.39	6.44	50.47	7.66	54.00	8.22	56.57	8.66	57.86	8.79	59.14	8.86
	8(46.4)	36.48	5.33	43.39	6.50	50.47	7.76	54.00	8.32	56.57	8.74	57.86	8.82	59.14	8.90
	10(50)	36.48	5.40	43.39	6.59	50.47	7.83	54.00	8.47	56.57	8.75	57.86	8.84	59.14	8.94
	12(53.6)	36.48	5.50	43.39	6.71	50.47	7.99	54.00	8.63	55.77	8.79	57.05	8.79	58.34	8.99
	14(57.2)	36.48	5.60	43.39	6.85	50.47	8.14	54.00	8.80	54.96	8.84	56.41	8.93	57.69	9.10
	16(60.8)	36.48	5.71	43.39	6.99	50.47	8.30	53.68	4.10	54.32	8.97	55.61	9.08	56.89	9.24
	18(64.4)	36.48	5.81	43.39	7.12	50.47	8.58	52.88	9.16	53.52	9.20	54.80	9.29	56.25	9.37
	20(68)	36.48	5.93	43.39	7.40	50.47	9.23	52.23	9.61	52.88	9.65	54.16	9.74	55.45	9.82
	21(69.8)	36.48	5.98	43.39	7.66	50.47	9.56	51.75	9.84	52.39	9.87	53.84	9.96	55.13	10.06
	23(73.4)	36.48	6.40	43.39	8.21	50.47	10.24	51.11	10.27	51.75	10.32	53.03	10.43	54.32	10.51
	25(77)	36.48	6.83	43.39	8.78	49.66	10.69	50.30	10.72	50.95	10.77	52.39	10.88	53.68	10.98
	27(80.6)	36.48	7.30	43.39	9.39	49.02	11.12	49.66	11.19	50.30	11.24	51.59	11.34	52.88	11.45
	29(84.2)	36.48	7.78	43.39	10.03	48.21	11.57	48.86	11.64	49.50	11.69	50.79	11.81	52.23	11.91
	31(87.8)	36.48	8.30	43.39	10.70	47.41	12.03	48.21	12.09	48.86	12.16	50.14	12.28	51.43	12.40
	33(91.4)	36.48	8.84	43.39	11.41	46.76	12.48	47.41	12.55	48.05	12.61	49.34	12.74	50.62	12.87
35(95)	36.48	9.41	43.39	12.17	45.96	12.93	46.61	13.00	47.41	13.07	48.69	13.21	49.98	13.35	
37(98.6)	36.48	10.01	43.39	12.97	45.32	13.40	45.96	13.47	46.61	13.54	47.89	13.68	49.18	13.83	
39(102.2)	36.48	10.65	43.23	13.69	44.52	13.85	45.16	13.94	45.80	14.01	47.25	14.16	48.54	14.30	
41(105.8)	36.48	10.94	42.88	13.79	44.17	13.95	44.81	14.03	45.46	14.10	46.90	14.20	47.14	14.41	
43(109.4)	36.48	11.11	42.65	13.89	43.82	14.03	44.46	14.09	45.11	14.15	46.08	14.24	46.41	14.70	
45(113)	36.48	11.24	42.42	14.02	43.40	14.16	44.00	14.22	44.71	14.26	45.15	14.28	45.94	15.01	
48(118.4)	36.48	11.43	42.06	14.22	42.84	14.34	43.30	14.40	44.22	14.53	44.45	14.56	45.34	15.21	

**Cooling capacity table**

**MVD-V5X450W/V2GN1**

TC: Total Capacity (kW); PI: Power Input (kW) (Compressor + Outdoor fan motor)

Combination (%)	Outdoor temperature (°C(°F) DB)	Indoor temperature(°C(°F))													
		DB:20.8(69.4) WB:14(57.2)		DB:23.3(73.9) WB:16(60.8)		DB:25.8(78.4) WB:18(64.4)		DB:27(80.6) WB:19(66.2)		DB:28.2(82.8) WB:20(68)		DB:30.7(87.3) WB:22(71.6)		DB:32(89.6) WB:24(75.2)	
		TC	PI	TC	PI	TC	PI	TC	PI	TC	PI	TC	PI	TC	PI
		kW	kW	kW	kW	kW	kW	kW	kW	kW	kW	kW	kW	kW	kW
110%	-5(23)	33.43	4.42	39.86	5.51	46.29	6.57	49.50	7.05	52.71	7.59	56.73	7.88	58.02	8.12
	-2(28.4)	33.43	4.51	39.86	5.58	46.29	6.63	49.50	7.12	52.71	7.65	56.73	7.96	58.02	8.17
	0(32)	33.43	4.55	39.86	5.61	46.29	6.68	49.50	7.17	52.71	7.73	56.73	8.04	58.02	8.27
	2(35.6)	33.43	4.65	39.86	5.66	46.29	6.78	49.50	7.25	52.71	7.82	56.73	8.15	58.02	8.37
	4(39.2)	33.43	4.75	39.86	5.73	46.29	6.85	49.50	7.34	52.71	7.94	56.73	8.27	58.02	8.45
	6(42.8)	33.43	4.79	39.86	5.79	46.29	6.91	49.50	7.45	52.71	8.02	56.73	8.35	58.02	8.58
	8(46.4)	33.43	4.84	39.86	5.89	46.29	6.99	49.50	7.53	52.71	8.12	56.73	8.41	58.02	8.67
	10(50)	33.43	4.89	39.86	5.97	46.29	7.09	49.50	7.66	52.71	8.25	56.73	8.47	58.02	8.74
	12(53.6)	33.43	5.00	39.86	6.09	46.29	7.23	49.50	7.82	52.71	8.40	56.09	8.59	57.22	8.86
	14(57.2)	33.43	5.08	39.86	6.19	46.29	7.37	49.50	7.95	52.71	8.56	55.29	8.66	56.57	8.92
	16(60.8)	33.43	5.17	39.86	6.31	46.29	7.50	49.50	8.11	52.71	8.73	54.65	8.77	55.77	9.02
	18(64.4)	33.43	5.27	39.86	6.43	46.29	7.66	49.50	8.33	52.71	9.15	53.84	9.22	55.13	9.30
	20(68)	33.43	5.38	39.86	6.57	46.29	8.11	49.50	8.96	51.91	9.60	53.20	9.67	54.33	9.75
	21(69.8)	33.43	5.43	39.86	6.76	46.29	8.40	49.50	9.29	51.59	9.82	52.72	9.89	54.00	9.98
	23(73.4)	33.43	5.69	39.86	7.25	46.29	9.01	49.50	9.96	50.79	10.25	52.08	10.36	53.20	10.44
	25(77)	33.43	6.07	39.86	7.75	46.29	9.63	49.50	10.67	50.14	10.70	51.27	10.81	52.55	10.89
	27(80.6)	33.43	6.47	39.86	8.28	46.29	10.31	48.70	11.12	49.34	11.15	50.63	11.26	51.75	11.36
	29(84.2)	33.43	6.90	39.86	8.84	46.29	11.01	48.05	11.57	48.70	11.62	49.82	11.72	51.11	11.83
	31(87.8)	33.43	7.35	39.86	9.42	46.29	11.76	47.25	12.02	47.89	12.07	49.18	12.17	50.30	12.29
	33(91.4)	33.43	7.82	39.86	10.05	45.97	12.40	46.61	12.47	47.25	12.52	48.38	12.64	49.66	12.76
35(95)	33.43	8.32	39.86	10.70	45.16	12.85	45.81	12.92	46.45	12.99	47.57	13.11	48.86	13.23	
37(98.6)	33.43	8.85	39.86	11.40	44.52	13.32	45.16	13.37	45.65	13.44	46.93	13.57	48.05	13.69	
39(102.2)	33.43	9.41	39.86	12.14	43.72	13.76	44.36	13.83	45.00	13.90	46.13	14.04	47.41	14.18	
41(105.8)	33.43	9.50	39.86	12.24	43.37	13.86	44.01	13.93	44.66	14.00	45.54	14.14	45.98	14.28	
43(109.4)	33.43	9.60	39.86	12.39	43.03	13.96	43.67	14.03	44.32	14.10	45.13	14.19	45.28	14.57	
45(113)	33.43	9.91	39.86	12.46	42.59	14.09	43.21	14.20	43.92	14.23	44.68	14.58	44.86	14.90	
48(118.4)	33.43	10.16	39.86	12.66	41.98	14.28	42.53	14.42	43.42	14.51	43.94	15.14	44.28	15.68	
100%	-5(23)	30.38	4.03	36.16	4.85	42.11	5.77	45.00	6.18	47.89	6.71	53.84	7.65	56.89	7.98
	-2(28.4)	30.38	4.08	36.16	4.91	42.11	5.84	45.00	6.30	47.89	6.80	53.84	7.74	56.89	8.03
	0(32)	30.38	4.12	36.16	4.97	42.11	5.90	45.00	6.38	47.89	6.86	53.84	7.86	56.89	8.12
	2(35.6)	30.38	4.20	36.16	5.03	42.11	5.97	45.00	6.46	47.89	6.94	53.84	7.98	56.89	8.25
	4(39.2)	30.38	4.23	36.16	5.08	42.11	6.06	45.00	6.56	47.89	7.03	53.84	8.06	56.89	8.34
	6(42.8)	30.38	4.29	36.16	5.18	42.11	6.13	45.00	6.67	47.89	7.13	53.84	8.17	56.89	8.47
	8(46.4)	30.38	4.38	36.16	5.26	42.11	6.25	45.00	6.75	47.89	7.25	53.84	8.30	56.89	8.61
	10(50)	30.38	4.43	36.16	5.36	42.11	6.35	45.00	6.86	47.89	7.38	53.84	8.44	56.89	8.73
	12(53.6)	30.38	4.50	36.16	5.46	42.11	6.47	45.00	6.99	47.89	7.52	53.84	8.59	56.09	8.80
	14(57.2)	30.38	4.58	36.16	5.57	42.11	6.59	45.00	7.12	47.89	7.66	53.84	8.77	55.44	8.91
	16(60.8)	30.38	4.67	36.16	5.67	42.11	6.73	45.00	7.26	47.89	7.82	53.52	8.87	54.64	9.01
	18(64.4)	30.38	4.75	36.16	5.77	42.11	6.85	45.00	7.40	47.89	7.97	52.88	9.16	54.00	9.23
	20(68)	30.38	4.84	36.16	5.90	42.11	7.06	45.00	7.78	47.89	8.54	52.07	9.60	53.19	9.68
	21(69.8)	30.38	4.89	36.16	5.95	42.11	7.31	45.00	8.06	47.89	8.84	51.75	9.82	52.88	9.91
	23(73.4)	30.38	5.01	36.16	6.35	42.11	7.83	45.00	8.63	47.89	9.47	51.11	10.27	52.07	10.36
	25(77)	30.38	5.34	36.16	6.78	42.11	8.39	45.00	9.25	47.89	10.15	50.31	10.72	51.43	10.81
	27(80.6)	30.38	5.71	36.16	7.23	42.11	8.96	45.00	9.89	47.89	10.86	49.50	11.17	50.63	11.27
	29(84.2)	30.38	6.07	36.16	7.71	42.11	9.56	45.00	10.57	47.73	11.53	48.86	11.64	49.98	11.72
	31(87.8)	30.38	6.47	36.16	8.23	42.11	10.20	45.00	11.27	47.09	11.98	48.06	12.09	49.18	12.19
	33(91.4)	30.38	6.86	36.16	8.77	42.11	10.88	45.00	12.03	46.29	12.43	47.41	12.54	48.54	12.66
35(95)	30.38	7.30	36.16	9.32	42.11	11.60	45.00	12.83	45.48	12.88	46.61	13.00	47.73	13.11	
37(98.6)	30.38	7.76	36.16	9.93	42.11	12.36	44.19	13.28	44.84	13.35	45.96	13.47	46.93	13.57	
39(102.2)	30.38	8.25	36.16	10.55	42.11	13.16	43.55	13.73	44.03	13.80	45.16	13.92	46.29	14.06	
41(105.8)	30.38	8.63	36.16	10.93	42.11	13.64	42.88	13.83	43.70	14.01	44.64	14.25	45.61	14.35	
43(109.4)	30.38	9.02	36.16	11.32	42.11	13.89	42.20	13.99	43.38	14.15	44.37	14.34	44.81	14.51	
45(113)	30.38	9.53	36.16	11.83	42.11	14.13	42.16	14.18	43.16	14.40	43.91	14.56	44.27	14.70	
48(118.4)	30.38	10.30	36.16	12.60	42.11	14.37	42.13	14.56	43.09	14.95	43.55	14.98	44.00	15.08	

**Cooling capacity table**

**MVD-V5X450W/V2GN1**

TC: Total Capacity (kW); PI: Power Input (kW) (Compressor + Outdoor fan motor)

Combination (%)	Outdoor temperature (°C(°F) DB)	Indoor temperature(°C(°F))													
		DB:20.8(69.4) WB:14(57.2)		DB:23.3(73.9) WB:16(60.8)		DB:25.8(78.4) WB:18(64.4)		DB:27(80.6) WB:19(66.2)		DB:28.2(82.8) WB:20(68)		DB:30.7(87.3) WB:22(71.6)		DB:32(89.6) WB:24(75.2)	
		TC	PI	TC	PI	TC	PI	TC	PI	TC	PI	TC	PI	TC	PI
		kW	kW	kW	kW	kW	kW	kW	kW	kW	kW	kW	kW	kW	kW
90%	-5(23)	27.32	3.56	32.63	4.28	37.93	5.04	40.50	5.50	43.07	5.85	48.37	6.73	53.68	7.71
	-2(28.4)	27.32	3.60	32.63	4.32	37.93	5.11	40.50	5.58	43.07	5.92	48.37	6.80	53.68	7.78
	0(32)	27.32	3.65	32.63	4.37	37.93	5.19	40.50	5.65	43.07	6.00	48.37	6.87	53.68	7.84
	2(35.6)	27.32	3.71	32.63	4.43	37.93	5.24	40.50	5.73	43.07	6.09	48.37	7.02	53.68	7.96
	4(39.2)	27.32	3.76	32.63	4.49	37.93	5.33	40.50	5.81	43.07	6.17	48.37	7.13	53.68	8.07
	6(42.8)	27.32	3.81	32.63	4.58	37.93	5.43	40.50	5.92	43.07	6.28	48.37	7.24	53.68	8.21
	8(46.4)	27.32	3.89	32.63	4.67	37.93	5.54	40.50	6.00	43.07	6.39	48.37	7.37	53.68	8.29
	10(50)	27.32	3.96	32.63	4.77	37.93	5.64	40.50	6.09	43.07	6.54	48.37	7.47	53.68	8.42
	12(53.6)	27.32	4.03	32.63	4.86	37.93	5.74	40.50	6.19	43.07	6.66	48.37	7.61	53.68	8.58
	14(57.2)	27.32	4.10	32.63	4.94	37.93	5.84	40.50	6.31	43.07	6.78	48.37	7.75	53.68	8.73
	16(60.8)	27.32	4.17	32.63	5.03	37.93	5.97	40.50	6.43	43.07	6.92	48.37	7.90	53.52	8.89
	18(64.4)	27.32	4.24	32.63	5.14	37.93	6.07	40.50	6.55	43.07	7.05	48.37	8.06	52.88	9.16
	20(68)	27.32	4.32	32.63	5.25	37.93	6.19	40.50	6.69	43.07	7.31	48.37	8.66	52.07	9.60
	21(69.8)	27.32	4.36	32.63	5.29	37.93	6.29	40.50	6.92	43.07	7.57	48.37	8.97	51.75	9.82
	23(73.4)	27.32	4.44	32.63	5.50	37.93	6.74	40.50	7.42	43.07	8.13	48.37	9.63	50.94	10.27
	25(77)	27.32	4.69	32.63	5.88	37.93	7.21	40.50	7.94	43.07	8.68	48.37	10.31	50.31	10.72
	27(80.6)	27.32	4.98	32.63	6.26	37.93	7.69	40.50	8.47	43.07	9.28	48.37	11.03	49.50	11.17
	29(84.2)	27.32	5.31	32.63	6.67	37.93	8.21	40.50	9.04	43.07	9.92	47.89	11.53	48.86	11.62
	31(87.8)	27.32	5.64	32.63	7.11	37.93	8.75	40.50	9.65	43.07	10.58	47.09	11.98	48.05	12.09
	33(91.4)	27.32	5.98	32.63	7.56	37.93	9.34	40.50	10.29	43.07	11.29	46.45	12.45	47.41	12.53
35(95)	27.32	6.36	32.63	8.04	37.93	9.94	40.50	10.96	43.07	12.03	45.64	12.90	46.61	13.00	
37(98.6)	27.32	6.74	32.63	8.54	37.93	10.58	40.50	11.67	43.07	12.83	44.84	13.35	45.96	13.45	
39(102.2)	27.32	7.16	32.63	9.10	37.93	11.26	40.50	12.43	43.07	13.66	44.20	13.82	45.16	13.92	
41(105.8)	27.32	7.40	32.63	9.51	37.93	11.67	40.50	12.76	43.07	13.74	43.89	14.17	44.86	14.25	
43(109.4)	27.32	7.76	32.63	9.92	37.93	12.08	40.50	13.09	43.07	14.03	43.66	14.35	44.47	14.47	
45(113)	27.32	8.25	32.63	10.41	37.93	12.57	40.50	13.53	43.07	14.42	43.42	14.50	43.79	14.66	
48(118.4)	27.32	8.91	32.63	11.07	37.93	13.23	40.50	14.19	43.07	14.75	43.25	14.79	43.46	14.91	
80%	-5(23)	24.27	3.14	28.93	3.71	33.59	4.40	36.00	4.67	38.41	5.03	43.07	5.82	47.73	6.64
	-2(28.4)	24.27	3.19	28.93	3.76	33.59	4.43	36.00	4.75	38.41	5.08	43.07	5.87	47.73	6.70
	0(32)	24.27	3.24	28.93	3.80	33.59	4.49	36.00	4.80	38.41	5.17	43.07	5.96	47.73	6.80
	2(35.6)	24.27	3.31	28.93	3.86	33.59	4.55	36.00	4.89	38.41	5.26	43.07	6.08	47.73	6.93
	4(39.2)	24.27	3.36	28.93	3.92	33.59	4.64	36.00	5.00	38.41	5.36	43.07	6.19	47.73	7.02
	6(42.8)	24.27	3.42	28.93	4.02	33.59	4.71	36.00	5.12	38.41	5.46	43.07	6.28	47.73	7.14
	8(46.4)	24.27	3.48	28.93	4.11	33.59	4.82	36.00	5.20	38.41	5.58	43.07	6.37	47.73	7.28
	10(50)	24.27	3.51	28.93	4.20	33.59	4.95	36.00	5.33	38.41	5.71	43.07	6.52	47.73	7.35
	12(53.6)	24.27	3.56	28.93	4.27	33.59	5.03	36.00	5.43	38.41	5.83	43.07	6.64	47.73	7.49
	14(57.2)	24.27	3.63	28.93	4.36	33.59	5.12	36.00	5.52	38.41	5.93	43.07	6.76	47.73	7.63
	16(60.8)	24.27	3.68	28.93	4.43	33.59	5.22	36.00	5.62	38.41	6.04	43.07	6.90	47.73	7.76
	18(64.4)	24.27	3.75	28.93	4.51	33.59	5.33	36.00	5.74	38.41	6.16	43.07	7.04	47.73	7.92
	20(68)	24.27	3.82	28.93	4.60	33.59	5.43	36.00	5.84	38.41	6.28	43.07	7.30	47.73	8.47
	21(69.8)	24.27	3.86	28.93	4.63	33.59	5.48	36.00	5.91	38.41	6.42	43.07	7.56	47.73	8.78
	23(73.4)	24.27	3.93	28.93	4.74	33.59	5.74	36.00	6.29	38.41	6.86	43.07	8.09	47.73	9.42
	25(77)	24.27	4.05	28.93	5.03	33.59	6.14	36.00	6.73	38.41	7.33	43.07	8.66	47.73	10.08
	27(80.6)	24.27	4.31	28.93	5.36	33.59	6.54	36.00	7.18	38.41	7.83	43.07	9.25	47.73	10.79
	29(84.2)	24.27	4.58	28.93	5.71	33.59	6.97	36.00	7.64	38.41	8.37	43.07	9.87	47.73	11.53
	31(87.8)	24.27	4.86	28.93	6.07	33.59	7.42	36.00	8.14	38.41	8.92	43.07	10.55	46.93	11.98
	33(91.4)	24.27	5.17	28.93	6.45	33.59	7.90	36.00	8.68	38.41	9.49	43.07	11.24	46.29	12.43
35(95)	24.27	5.48	28.93	6.86	33.59	8.40	36.00	9.23	38.41	10.12	43.07	11.98	45.48	12.88	
37(98.6)	24.27	5.81	28.93	7.28	33.59	8.94	36.00	9.84	38.41	10.77	43.07	12.78	44.84	13.33	
39(102.2)	24.27	6.16	28.93	7.76	33.59	9.51	36.00	10.46	38.41	11.46	43.07	13.61	44.04	13.80	
41(105.8)	24.27	6.29	28.93	7.83	33.59	9.65	36.00	10.74	38.41	11.67	43.07	13.95	43.77	14.04	
43(109.4)	24.27	6.48	28.93	7.90	33.59	9.79	36.00	10.92	38.41	11.83	43.07	14.12	43.50	14.19	
45(113)	24.27	6.66	28.93	7.99	33.59	9.98	36.00	11.15	38.41	12.04	43.07	14.27	42.96	14.42	
48(118.4)	24.27	6.80	28.93	8.13	33.59	10.27	36.00	11.57	38.41	12.38	43.07	14.60	42.60	14.92	

**Cooling capacity table**

**MVD-V5X450W/V2GN1**

TC: Total Capacity (kW); PI: Power Input (kW) (Compressor + Outdoor fan motor)

Combination (%)	Outdoor temperature (°C(°F) DB)	Indoor temperature(°C(°F))													
		DB:20.8(69.4) WB:14(57.2)		DB:23.3(73.9) WB:16(60.8)		DB:25.8(78.4) WB:18(64.4)		DB:27(80.6) WB:19(66.2)		DB:28.2(82.8) WB:20(68)		DB:30.7(87.3) WB:22(71.6)		DB:32(89.6) WB:24(75.2)	
		TC	PI	TC	PI	TC	PI	TC	PI	TC	PI	TC	PI	TC	PI
		kW	kW	kW	kW	kW	kW	kW	kW	kW	kW	kW	kW	kW	kW
70%	-5(23)	21.22	2.80	25.39	3.29	29.41	3.72	31.50	3.99	33.59	4.26	37.61	4.88	41.78	5.60
	-2(28.4)	21.22	2.83	25.39	3.30	29.41	3.75	31.50	4.07	33.59	4.34	37.61	4.95	41.78	5.68
	0(32)	21.22	2.84	25.39	3.35	29.41	3.82	31.50	4.15	33.59	4.41	37.61	5.05	41.78	5.76
	2(35.6)	21.22	2.86	25.39	3.36	29.41	3.89	31.50	4.22	33.59	4.49	37.61	5.16	41.78	5.85
	4(39.2)	21.22	2.89	25.39	3.45	29.41	3.97	31.50	4.30	33.59	4.59	37.61	5.24	41.78	5.99
	6(42.8)	21.22	2.94	25.39	3.51	29.41	4.07	31.50	4.44	33.59	4.70	37.61	5.34	41.78	6.10
	8(46.4)	21.22	2.99	25.39	3.61	29.41	4.16	31.50	4.51	33.59	4.80	37.61	5.49	41.78	6.22
	10(50)	21.22	3.06	25.39	3.67	29.41	4.27	31.50	4.60	33.59	4.93	37.61	5.60	41.78	6.29
	12(53.6)	21.22	3.13	25.39	3.72	29.41	4.36	31.50	4.69	33.59	5.01	37.61	5.71	41.78	6.42
	14(57.2)	21.22	3.18	25.39	3.79	29.41	4.43	31.50	4.76	33.59	5.10	37.61	5.81	41.78	6.54
	16(60.8)	21.22	3.23	25.39	3.86	29.41	4.51	31.50	4.86	33.59	5.20	37.61	5.91	41.78	6.66
	18(64.4)	21.22	3.29	25.39	3.93	29.41	4.60	31.50	4.95	33.59	5.29	37.61	6.03	41.78	6.80
	20(68)	21.22	3.34	25.39	3.99	29.41	4.69	31.50	5.03	33.59	5.39	37.61	6.16	41.78	6.99
	21(69.8)	21.22	3.37	25.39	4.03	29.41	4.72	31.50	5.08	33.59	5.45	37.61	6.24	41.78	7.23
	23(73.4)	21.22	3.42	25.39	4.10	29.41	4.82	31.50	5.26	33.59	5.72	37.61	6.69	41.78	7.75
	25(77)	21.22	3.49	25.39	4.27	29.41	5.14	31.50	5.62	33.59	6.10	37.61	7.16	41.78	8.28
	27(80.6)	21.22	3.70	25.39	4.55	29.41	5.48	31.50	5.98	33.59	6.52	37.61	7.64	41.78	8.85
	29(84.2)	21.22	3.93	25.39	4.82	29.41	5.83	31.50	6.38	33.59	6.93	37.61	8.14	41.78	9.46
	31(87.8)	21.22	4.15	25.39	5.12	29.41	6.21	31.50	6.78	33.59	7.38	37.61	8.68	41.78	10.08
	33(91.4)	21.22	4.41	25.39	5.45	29.41	6.61	31.50	7.21	33.59	7.87	37.61	9.25	41.78	10.76
35(95)	21.22	4.67	25.39	5.78	29.41	7.00	31.50	7.68	33.59	8.37	37.61	9.86	41.78	11.46	
37(98.6)	21.22	4.93	25.39	6.12	29.41	7.45	31.50	8.14	33.59	8.91	37.61	10.50	41.78	12.21	
39(102.2)	21.22	5.22	25.39	6.48	29.41	7.90	31.50	8.66	33.59	9.46	37.61	11.15	41.78	13.00	
41(105.8)	21.22	5.45	25.39	6.71	29.41	8.13	31.50	8.95	33.59	9.75	37.61	11.61	41.78	13.58	
43(109.4)	21.22	5.90	25.39	7.18	29.41	8.47	31.50	9.43	33.59	10.03	37.61	12.04	41.78	14.00	
45(113)	21.22	6.03	25.39	7.33	29.41	8.65	31.50	9.58	33.59	10.53	37.61	12.69	41.78	14.54	
48(118.4)	21.22	6.42	25.39	7.79	29.41	9.18	31.50	10.05	33.59	10.84	37.61	13.07	41.78	14.85	
60%	-5(23)	18.16	2.39	21.70	2.77	25.23	3.23	27.00	3.44	28.77	3.72	32.30	4.17	35.84	4.79
	-2(28.4)	18.16	2.40	21.70	2.82	25.23	3.29	27.00	3.49	28.77	3.76	32.30	4.24	35.84	4.82
	0(32)	18.16	2.44	21.70	2.85	25.23	3.33	27.00	3.54	28.77	3.82	32.30	4.30	35.84	4.88
	2(35.6)	18.16	2.48	21.70	2.92	25.23	3.40	27.00	3.60	28.77	3.87	32.30	4.39	35.84	4.94
	4(39.2)	18.16	2.55	21.70	2.97	25.23	3.46	27.00	3.65	28.77	3.93	32.30	4.46	35.84	5.01
	6(42.8)	18.16	2.58	21.70	3.03	25.23	3.53	27.00	3.73	28.77	4.01	32.30	4.55	35.84	5.13
	8(46.4)	18.16	2.63	21.70	3.08	25.23	3.59	27.00	3.80	28.77	4.09	32.30	4.63	35.84	5.21
	10(50)	18.16	2.68	21.70	3.15	25.23	3.65	27.00	3.91	28.77	4.17	32.30	4.72	35.84	5.29
	12(53.6)	18.16	2.73	21.70	3.20	25.23	3.72	27.00	3.98	28.77	4.24	32.30	4.81	35.84	5.38
	14(57.2)	18.16	2.77	21.70	3.25	25.23	3.77	27.00	4.05	28.77	4.32	32.30	4.89	35.84	5.48
	16(60.8)	18.16	2.80	21.70	3.30	25.23	3.84	27.00	4.11	28.77	4.39	32.30	4.98	35.84	5.58
	18(64.4)	18.16	2.85	21.70	3.35	25.23	3.91	27.00	4.18	28.77	4.48	32.30	5.07	35.84	5.69
	20(68)	18.16	2.89	21.70	3.42	25.23	3.98	27.00	4.27	28.77	4.56	32.30	5.17	35.84	5.81
	21(69.8)	18.16	2.92	21.70	3.44	25.23	4.01	27.00	4.30	28.77	4.60	32.30	5.22	35.84	5.86
	23(73.4)	18.16	2.96	21.70	3.51	25.23	4.08	27.00	4.39	28.77	4.69	32.30	5.43	35.84	6.24
	25(77)	18.16	3.01	21.70	3.56	25.23	4.24	27.00	4.60	28.77	4.98	32.30	5.79	35.84	6.66
	27(80.6)	18.16	3.13	21.70	3.79	25.23	4.51	27.00	4.91	28.77	5.31	32.30	6.17	35.84	7.11
	29(84.2)	18.16	3.30	21.70	4.01	25.23	4.81	27.00	5.22	28.77	5.65	32.30	6.59	35.84	7.59
	31(87.8)	18.16	3.51	21.70	4.25	25.23	5.10	27.00	5.55	28.77	6.02	32.30	7.00	35.84	8.07
	33(91.4)	18.16	3.70	21.70	4.51	25.23	5.41	27.00	5.90	28.77	6.40	32.30	7.45	35.84	8.61
35(95)	18.16	3.92	21.70	4.79	25.23	5.74	27.00	6.26	28.77	6.79	32.30	7.94	35.84	9.16	
37(98.6)	18.16	4.15	21.70	5.07	25.23	6.09	27.00	6.64	28.77	7.21	32.30	8.44	35.84	9.75	
39(102.2)	18.16	4.37	21.70	5.36	25.23	6.45	27.00	7.04	28.77	7.66	32.30	8.96	35.84	10.37	
41(105.8)	18.16	4.51	21.70	5.59	25.23	6.68	27.00	7.32	28.77	7.94	32.30	9.38	35.84	10.84	
43(109.4)	18.16	4.66	21.70	5.83	25.23	6.92	27.00	7.54	28.77	8.22	32.30	9.78	35.84	11.31	
45(113)	18.16	4.87	21.70	6.12	25.23	7.20	27.00	7.82	28.77	8.62	32.30	10.21	35.84	11.94	
48(118.4)	18.16	5.25	21.70	6.53	25.23	7.58	27.00	8.29	28.77	9.30	32.30	10.76	35.84	12.88	

**Cooling capacity table**

**MVD-V5X450W/V2GN1**

TC: Total Capacity (kW); PI: Power Input (kW) (Compressor + Outdoor fan motor)

Combination (%)	Outdoor temperature (°C(°F) DB)	Indoor temperature(°C(°F))													
		DB:20.8(69.4) WB:14(57.2)		DB:23.3(73.9) WB:16(60.8)		DB:25.8(78.4) WB:18(64.4)		DB:27(80.6) WB:19(66.2)		DB:28.2(82.8) WB:20(68)		DB:30.7(87.3) WB:22(71.6)		DB:32(89.6) WB:24(75.2)	
		TC	PI	TC	PI	TC	PI	TC	PI	TC	PI	TC	PI	TC	PI
		kW	kW	kW	kW	kW	kW	kW	kW	kW	kW	kW	kW	kW	kW
50%	-5(23)	15.19	2.08	18.16	2.40	21.05	2.76	22.50	2.89	23.95	3.05	26.84	3.47	29.89	3.73
	-2(28.4)	15.19	2.09	18.16	2.45	21.05	2.79	22.50	2.93	23.95	3.10	26.84	3.51	29.89	3.78
	0(32)	15.19	2.13	18.16	2.49	21.05	2.84	22.50	2.97	23.95	3.14	26.84	3.57	29.89	3.85
	2(35.6)	15.19	2.16	18.16	2.52	21.05	2.89	22.50	3.01	23.95	3.19	26.84	3.59	29.89	3.92
	4(39.2)	15.19	2.18	18.16	2.56	21.05	2.92	22.50	3.05	23.95	3.26	26.84	3.67	29.89	4.02
	6(42.8)	15.19	2.22	18.16	2.60	21.05	2.96	22.50	3.12	23.95	3.32	26.84	3.73	29.89	4.14
	8(46.4)	15.19	2.27	18.16	2.65	21.05	3.01	22.50	3.19	23.95	3.36	26.84	3.79	29.89	4.28
	10(50)	15.19	2.32	18.16	2.68	21.05	3.06	22.50	3.24	23.95	3.46	26.84	3.89	29.89	4.34
	12(53.6)	15.19	2.33	18.16	2.71	21.05	3.11	22.50	3.30	23.95	3.53	26.84	3.96	29.89	4.41
	14(57.2)	15.19	2.37	18.16	2.75	21.05	3.15	22.50	3.37	23.95	3.58	26.84	4.03	29.89	4.50
	16(60.8)	15.19	2.40	18.16	2.78	21.05	3.20	22.50	3.42	23.95	3.63	26.84	4.10	29.89	4.56
	18(64.4)	15.19	2.44	18.16	2.84	21.05	3.25	22.50	3.48	23.95	3.70	26.84	4.17	29.89	4.65
	20(68)	15.19	2.47	18.16	2.87	21.05	3.30	22.50	3.53	23.95	3.77	26.84	4.24	29.89	4.74
	21(69.8)	15.19	2.49	18.16	2.90	21.05	3.34	22.50	3.56	23.95	3.80	26.84	4.29	29.89	4.79
	23(73.4)	15.19	2.52	18.16	2.94	21.05	3.39	22.50	3.63	23.95	3.87	26.84	4.36	29.89	4.89
	25(77)	15.19	2.56	18.16	2.99	21.05	3.46	22.50	3.70	23.95	3.99	26.84	4.58	29.89	5.22
	27(80.6)	15.19	2.61	18.16	3.11	21.05	3.65	22.50	3.94	23.95	4.24	26.84	4.88	29.89	5.57
	29(84.2)	15.19	2.75	18.16	3.28	21.05	3.87	22.50	4.18	23.95	4.51	26.84	5.19	29.89	5.93
	31(87.8)	15.19	2.90	18.16	3.48	21.05	4.10	22.50	4.44	23.95	4.79	26.84	5.52	29.89	6.31
	33(91.4)	15.19	3.08	18.16	3.68	21.05	4.36	22.50	4.70	23.95	5.08	26.84	5.86	29.89	6.71
35(95)	15.19	3.25	18.16	3.89	21.05	4.60	22.50	4.98	23.95	5.38	26.84	6.22	29.89	7.12	
37(98.6)	15.19	3.42	18.16	4.11	21.05	4.88	22.50	5.27	23.95	5.71	26.84	6.60	29.89	7.57	
39(102.2)	15.19	3.61	18.16	4.34	21.05	5.15	22.50	5.58	23.95	6.05	26.84	7.00	29.89	8.04	
41(105.8)	15.19	3.76	18.16	4.53	21.05	5.34	22.50	5.85	23.95	6.31	26.84	7.38	29.89	8.41	
43(109.4)	15.19	4.01	18.16	4.84	21.05	5.53	22.50	6.11	23.95	6.47	26.84	7.75	29.89	8.79	
45(113)	15.19	4.10	18.16	4.96	21.05	5.90	22.50	6.58	23.95	6.75	26.84	8.50	29.89	9.53	
48(118.4)	15.19	4.38	18.16	5.34	21.05	6.15	22.50	6.88	23.95	6.95	26.84	8.99	29.89	10.03	

**Cooling capacity table**

**MVD-V5X500W/V2GN1**

TC: Total Capacity (kW); PI: Power Input (kW) (Compressor + Outdoor fan motor)

Combination (%)	Outdoor temperature (°C(°F) DB)	Indoor temperature(°C(°F))													
		DB:20.8(69.4) WB:14(57.2)		DB:23.3(73.9) WB:16(60.8)		DB:25.8(78.4) WB:18(64.4)		DB:27(80.6) WB:19(66.2)		DB:28.2(82.8) WB:20(68)		DB:30.7(87.3) WB:22(71.6)		DB:32(89.6) WB:24(75.2)	
		TC	PI	TC	PI	TC	PI	TC	PI	TC	PI	TC	PI	TC	PI
		kW	kW	kW	kW	kW	kW	kW	kW	kW	kW	kW	kW	kW	kW
130%	-5(23)	43.93	5.91	52.32	7.22	60.71	7.74	63.03	8.05	66.06	8.28	67.68	9.01	69.38	9.06
	-2(28.4)	43.93	5.91	52.32	7.36	60.71	7.74	63.03	8.10	66.06	8.28	67.68	9.12	69.38	9.15
	0(32)	43.93	6.02	52.32	7.49	60.71	8.02	63.03	8.55	66.06	8.76	67.68	9.23	69.38	9.28
	2(35.6)	43.93	6.12	52.32	7.50	60.71	8.30	63.03	9.03	66.06	8.86	67.68	9.30	69.38	9.41
	4(39.2)	43.93	6.26	52.32	7.65	60.71	8.58	63.03	9.06	66.06	8.98	67.68	9.29	69.38	9.59
	6(42.8)	43.93	6.38	52.32	7.80	60.71	8.90	63.03	9.14	65.33	9.26	66.85	9.29	68.62	9.66
	8(46.4)	43.93	6.53	52.32	7.98	60.71	9.35	63.03	9.59	64.52	9.56	66.12	3.90	67.74	9.76
	10(50)	43.93	6.67	52.32	8.15	60.71	9.69	63.03	9.91	63.75	4.04	65.36	4.06	66.96	10.04
	12(53.6)	43.93	6.79	52.32	8.31	60.71	9.89	62.14	4.03	63.03	4.06	64.46	4.07	66.07	10.10
	14(57.2)	43.93	6.92	52.32	8.46	60.53	4.05	61.43	4.06	62.14	4.08	63.75	4.09	65.36	10.33
	16(60.8)	43.93	7.04	52.32	8.64	59.82	4.06	60.53	4.08	61.25	4.10	62.86	4.12	64.46	10.49
	18(64.4)	43.93	7.18	52.32	8.82	58.93	10.34	59.64	10.40	60.53	10.45	62.14	10.55	63.75	10.65
	20(68)	43.93	7.33	52.32	9.38	58.03	10.84	58.93	10.90	59.64	10.96	61.25	11.06	62.86	11.17
	21(69.8)	43.93	7.53	52.32	9.71	57.68	11.10	58.57	11.16	59.28	11.21	60.89	11.33	62.50	11.43
	23(73.4)	43.93	8.07	52.32	10.41	56.96	11.60	57.68	11.66	58.39	11.72	60.00	11.84	61.60	11.96
	25(77)	43.93	8.62	52.32	11.16	56.07	12.11	56.78	12.17	57.68	12.25	59.28	12.36	60.89	12.48
	27(80.6)	43.93	9.21	52.32	11.94	55.36	12.62	56.07	12.70	56.78	12.75	58.39	12.89	60.00	13.03
	29(84.2)	43.93	9.83	52.32	12.75	54.46	13.12	55.18	13.20	56.07	13.28	57.68	13.42	59.28	13.55
	31(87.8)	43.93	10.49	52.14	13.50	53.57	13.65	54.46	13.73	55.18	13.79	56.78	13.94	58.39	14.10
	33(91.4)	43.93	11.17	51.25	14.00	52.86	14.16	53.57	14.24	54.46	14.31	56.07	14.47	57.50	14.63
35(95)	43.93	11.92	50.35	14.51	51.96	14.69	52.86	14.76	53.57	14.84	55.18	15.02	56.78	15.17	
37(98.6)	43.93	12.68	49.64	15.04	51.25	15.21	51.96	15.29	52.86	15.39	54.28	15.56	55.89	15.74	
39(102.2)	43.93	13.50	48.75	15.19	50.35	15.72	51.25	15.82	51.96	15.91	53.57	16.09	55.18	16.28	
41(105.8)	43.93	14.20	48.25	15.34	49.83	15.87	50.72	15.96	51.43	16.06	53.04	16.12	53.06	16.43	
43(109.4)	43.93	14.57	47.89	15.41	49.56	15.91	50.46	16.04	50.90	16.08	52.08	16.15	52.43	16.47	
45(113)	43.93	15.29	47.59	15.56	49.03	16.06	49.93	16.14	50.16	16.16	50.66	16.21	51.40	16.78	
48(118.4)	43.93	16.38	47.44	15.78	48.24	16.37	49.13	16.23	49.53	16.31	49.31	16.30	50.21	17.60	
120%	-5(23)	40.54	5.71	48.21	6.92	56.07	8.18	60.00	8.92	62.86	9.30	64.29	9.60	65.72	9.86
	-2(28.4)	40.54	5.77	48.21	6.99	56.07	8.26	60.00	8.98	62.86	9.41	64.29	9.68	65.72	9.89
	0(32)	40.54	5.82	48.21	7.04	56.07	8.36	60.00	9.00	62.86	9.50	64.29	9.74	65.72	9.91
	2(35.6)	40.54	5.84	48.21	7.11	56.07	8.42	60.00	9.08	62.86	9.53	64.29	9.81	65.72	9.93
	4(39.2)	40.54	5.90	48.21	7.20	56.07	8.54	60.00	9.17	62.86	9.66	64.29	9.83	65.72	9.96
	6(42.8)	40.54	5.96	48.21	7.26	56.07	8.64	60.00	9.27	62.86	9.76	64.29	9.91	65.72	9.99
	8(46.4)	40.54	6.01	48.21	7.33	56.07	8.76	60.00	9.39	62.86	9.86	64.29	9.94	65.72	10.04
	10(50)	40.54	6.08	48.21	7.43	56.07	8.83	60.00	9.56	62.86	9.87	64.29	9.97	65.72	10.08
	12(53.6)	40.54	6.20	48.21	7.57	56.07	9.01	60.00	9.73	61.97	9.91	63.39	9.92	64.82	10.14
	14(57.2)	40.54	6.32	48.21	7.72	56.07	9.18	60.00	9.93	61.07	9.97	62.68	10.07	64.10	10.27
	16(60.8)	40.54	6.44	48.21	7.88	56.07	9.36	59.64	4.10	60.36	10.12	61.78	10.24	63.21	10.42
	18(64.4)	40.54	6.55	48.21	8.04	56.07	9.67	58.75	10.34	59.46	10.37	60.89	10.47	62.50	10.57
	20(68)	40.54	6.69	48.21	8.35	56.07	10.41	58.04	10.84	58.75	10.88	60.18	10.98	61.61	11.08
	21(69.8)	40.54	6.75	48.21	8.64	56.07	10.78	57.50	11.10	58.21	11.14	59.82	11.23	61.25	11.35
	23(73.4)	40.54	7.22	48.21	9.26	56.07	11.54	56.79	11.58	57.50	11.64	58.93	11.76	60.36	11.86
	25(77)	40.54	7.70	48.21	9.91	55.18	12.05	55.89	12.09	56.61	12.15	58.21	12.27	59.64	12.38
	27(80.6)	40.54	8.23	48.21	10.59	54.46	12.54	55.18	12.62	55.89	12.68	57.32	12.79	58.75	12.91
	29(84.2)	40.54	8.78	48.21	11.31	53.57	13.05	54.29	13.12	55.00	13.18	56.43	13.32	58.04	13.44
	31(87.8)	40.54	9.36	48.21	12.07	52.68	13.57	53.57	13.63	54.29	13.71	55.72	13.85	57.14	13.98
	33(91.4)	40.54	9.97	48.21	12.87	51.96	14.08	52.68	14.16	53.39	14.22	54.82	14.37	56.25	14.51
35(95)	40.54	10.61	48.21	13.73	51.07	14.58	51.79	14.67	52.68	14.74	54.10	14.90	55.53	15.06	
37(98.6)	40.54	11.29	48.21	14.63	50.36	15.11	51.07	15.19	51.79	15.27	53.21	15.43	54.64	15.60	
39(102.2)	40.54	12.01	48.04	15.45	49.47	15.62	50.18	15.72	50.89	15.80	52.50	15.97	53.93	16.13	
41(105.8)	40.54	12.34	47.65	15.56	49.08	15.73	49.79	15.83	50.51	15.91	52.11	16.02	52.38	16.25	
43(109.4)	40.54	12.53	47.39	15.67	48.69	15.83	49.40	15.89	50.12	15.96	51.21	16.06	51.56	16.57	
45(113)	40.54	12.67	47.13	15.81	48.22	15.97	48.89	16.04	49.68	16.09	50.17	16.11	51.05	16.93	
48(118.4)	40.54	12.89	46.73	16.03	47.60	16.17	48.11	16.24	49.13	16.39	49.39	16.42	50.37	17.15	

**Cooling capacity table**

**MVD-V5X500W/V2GN1**

TC: Total Capacity (kW); PI: Power Input (kW) (Compressor + Outdoor fan motor)

Combination (%)	Outdoor temperature (°C(°F) DB)	Indoor temperature(°C(°F))													
		DB:20.8(69.4) WB:14(57.2)		DB:23.3(73.9) WB:16(60.8)		DB:25.8(78.4) WB:18(64.4)		DB:27(80.6) WB:19(66.2)		DB:28.2(82.8) WB:20(68)		DB:30.7(87.3) WB:22(71.6)		DB:32(89.6) WB:24(75.2)	
		TC	PI	TC	PI	TC	PI	TC	PI	TC	PI	TC	PI	TC	PI
		kW	kW	kW	kW	kW	kW	kW	kW	kW	kW	kW	kW	kW	kW
110%	-5(23)	37.14	4.99	44.29	6.21	51.43	7.41	55.00	7.95	58.57	8.56	63.04	8.89	64.47	9.16
	-2(28.4)	37.14	5.08	44.29	6.29	51.43	7.47	55.00	8.03	58.57	8.63	63.04	8.98	64.47	9.21
	0(32)	37.14	5.14	44.29	6.33	51.43	7.53	55.00	8.09	58.57	8.72	63.04	9.07	64.47	9.32
	2(35.6)	37.14	5.25	44.29	6.39	51.43	7.65	55.00	8.17	58.57	8.82	63.04	9.20	64.47	9.44
	4(39.2)	37.14	5.35	44.29	6.46	51.43	7.72	55.00	8.27	58.57	8.95	63.04	9.32	64.47	9.53
	6(42.8)	37.14	5.40	44.29	6.53	51.43	7.80	55.00	8.41	58.57	9.05	63.04	9.42	64.47	9.67
	8(46.4)	37.14	5.45	44.29	6.64	51.43	7.88	55.00	8.49	58.57	9.15	63.04	9.49	64.47	9.78
	10(50)	37.14	5.52	44.29	6.73	51.43	8.00	55.00	8.64	58.57	9.30	63.04	9.55	64.47	9.86
	12(53.6)	37.14	5.64	44.29	6.86	51.43	8.15	55.00	8.82	58.57	9.48	62.33	9.69	63.57	9.99
	14(57.2)	37.14	5.73	44.29	6.98	51.43	8.31	55.00	8.97	58.57	9.65	61.43	9.77	62.86	10.06
	16(60.8)	37.14	5.83	44.29	7.12	51.43	8.46	55.00	9.15	58.57	9.85	60.72	9.89	61.96	10.17
	18(64.4)	37.14	5.95	44.29	7.26	51.43	8.64	55.00	9.40	58.57	10.32	59.82	10.39	61.25	10.49
	20(68)	37.14	6.06	44.29	7.41	51.43	9.15	55.00	10.10	57.68	10.82	59.11	10.90	60.36	11.00
	21(69.8)	37.14	6.12	44.29	7.63	51.43	9.48	55.00	10.47	57.32	11.08	58.58	11.16	60.00	11.25
	23(73.4)	37.14	6.42	44.29	8.17	51.43	10.16	55.00	11.23	56.43	11.56	57.86	11.68	59.11	11.78
	25(77)	37.14	6.85	44.29	8.74	51.43	10.86	55.00	12.03	55.71	12.07	56.97	12.19	58.39	12.29
	27(80.6)	37.14	7.29	44.29	9.34	51.43	11.62	54.11	12.54	54.82	12.58	56.25	12.70	57.50	12.81
	29(84.2)	37.14	7.78	44.29	9.97	51.43	12.42	53.39	13.05	54.11	13.11	55.36	13.22	56.79	13.34
	31(87.8)	37.14	8.29	44.29	10.63	51.43	13.26	52.50	13.55	53.22	13.61	54.65	13.73	55.89	13.87
	33(91.4)	37.14	8.82	44.29	11.33	51.07	13.98	51.79	14.06	52.50	14.12	53.75	14.26	55.18	14.39
35(95)	37.14	9.38	44.29	12.07	50.18	14.49	50.90	14.57	51.61	14.65	52.86	14.78	54.29	14.92	
37(98.6)	37.14	9.99	44.29	12.85	49.46	15.02	50.18	15.08	50.72	15.15	52.15	15.31	53.39	15.45	
39(102.2)	37.14	10.61	44.29	13.69	48.57	15.52	49.29	15.60	50.00	15.68	51.25	15.84	52.68	15.99	
41(105.8)	37.14	10.72	44.29	13.80	48.19	15.63	48.91	15.71	49.62	15.79	50.60	15.95	51.09	16.10	
43(109.4)	37.14	10.83	44.29	13.98	47.81	15.74	48.52	15.82	49.24	15.90	50.15	16.00	50.31	16.43	
45(113)	37.14	11.18	44.29	14.06	47.33	15.89	48.01	16.01	48.80	16.04	49.64	16.44	49.84	16.81	
48(118.4)	37.14	11.45	44.29	14.27	46.64	16.11	47.25	16.26	48.25	16.36	48.82	17.08	49.20	17.69	
100%	-5(23)	33.75	4.54	40.18	5.47	46.79	6.51	50.00	6.97	53.22	7.57	59.82	8.62	63.22	9.00
	-2(28.4)	33.75	4.60	40.18	5.54	46.79	6.58	50.00	7.10	53.22	7.67	59.82	8.73	63.22	9.06
	0(32)	33.75	4.64	40.18	5.60	46.79	6.66	50.00	7.19	53.22	7.74	59.82	8.87	63.22	9.16
	2(35.6)	33.75	4.74	40.18	5.68	46.79	6.73	50.00	7.29	53.22	7.83	59.82	9.00	63.22	9.30
	4(39.2)	33.75	4.77	40.18	5.73	46.79	6.83	50.00	7.39	53.22	7.93	59.82	9.09	63.22	9.41
	6(42.8)	33.75	4.84	40.18	5.85	46.79	6.92	50.00	7.52	53.22	8.05	59.82	9.22	63.22	9.55
	8(46.4)	33.75	4.93	40.18	5.93	46.79	7.04	50.00	7.61	53.22	8.18	59.82	9.36	63.22	9.71
	10(50)	33.75	4.99	40.18	6.05	46.79	7.16	50.00	7.74	53.22	8.33	59.82	9.52	63.22	9.85
	12(53.6)	33.75	5.07	40.18	6.16	46.79	7.29	50.00	7.88	53.22	8.48	59.82	9.69	62.32	9.92
	14(57.2)	33.75	5.17	40.18	6.28	46.79	7.43	50.00	8.04	53.22	8.64	59.82	9.89	61.61	10.05
	16(60.8)	33.75	5.27	40.18	6.40	46.79	7.59	50.00	8.19	53.22	8.82	59.47	10.00	60.72	10.16
	18(64.4)	33.75	5.36	40.18	6.51	46.79	7.72	50.00	8.35	53.22	8.99	58.75	10.34	60.00	10.41
	20(68)	33.75	5.46	40.18	6.65	46.79	7.96	50.00	8.77	53.22	9.63	57.86	10.82	59.11	10.92
	21(69.8)	33.75	5.52	40.18	6.71	46.79	8.25	50.00	9.09	53.22	9.97	57.50	11.08	58.75	11.17
	23(73.4)	33.75	5.65	40.18	7.16	46.79	8.83	50.00	9.73	53.22	10.69	56.79	11.58	57.86	11.68
	25(77)	33.75	6.03	40.18	7.64	46.79	9.46	50.00	10.43	53.22	11.45	55.90	12.09	57.14	12.19
	27(80.6)	33.75	6.43	40.18	8.15	46.79	10.10	50.00	11.15	53.22	12.25	55.00	12.60	56.25	12.71
	29(84.2)	33.75	6.84	40.18	8.70	46.79	10.78	50.00	11.92	53.04	13.01	54.29	13.12	55.54	13.22
	31(87.8)	33.75	7.29	40.18	9.28	46.79	11.51	50.00	12.71	52.32	13.51	53.40	13.63	54.64	13.75
	33(91.4)	33.75	7.74	40.18	9.89	46.79	12.27	50.00	13.57	51.43	14.02	52.68	14.14	53.93	14.27
35(95)	33.75	8.23	40.18	10.51	46.79	13.09	50.00	14.47	50.54	14.53	51.79	14.66	53.04	14.78	
37(98.6)	33.75	8.76	40.18	11.19	46.79	13.94	49.10	14.98	49.82	15.05	51.07	15.19	52.15	15.31	
39(102.2)	33.75	9.30	40.18	11.90	46.79	14.84	48.39	15.48	48.93	15.56	50.18	15.70	51.43	15.85	
41(105.8)	33.75	9.74	40.18	12.33	46.79	15.38	47.64	15.59	48.55	15.80	49.60	16.07	50.68	16.18	
43(109.4)	33.75	10.17	40.18	12.76	46.79	15.67	46.89	15.77	48.20	15.95	49.30	16.17	49.79	16.36	
45(113)	33.75	10.75	40.18	13.34	46.79	15.94	46.84	15.99	47.95	16.24	48.79	16.42	49.19	16.58	
48(118.4)	33.75	11.62	40.18	14.21	46.79	16.21	46.81	16.43	47.88	16.86	48.39	16.89	48.89	17.01	



**Cooling capacity table**

**MVD-V5X500W/V2GN1**

TC: Total Capacity (kW); PI: Power Input (kW) (Compressor + Outdoor fan motor)

Combination (%)	Outdoor temperature (°C(°F) DB)	Indoor temperature(°C(°F))													
		DB:20.8(69.4) WB:14(57.2)		DB:23.3(73.9) WB:16(60.8)		DB:25.8(78.4) WB:18(64.4)		DB:27(80.6) WB:19(66.2)		DB:28.2(82.8) WB:20(68)		DB:30.7(87.3) WB:22(71.6)		DB:32(89.6) WB:24(75.2)	
		TC	PI	TC	PI	TC	PI	TC	PI	TC	PI	TC	PI	TC	PI
		kW	kW	kW	kW	kW	kW	kW	kW	kW	kW	kW	kW	kW	kW
90%	-5(23)	30.36	4.02	36.25	4.82	42.14	5.69	45.00	6.21	47.86	6.60	53.75	7.59	59.64	8.69
	-2(28.4)	30.36	4.06	36.25	4.87	42.14	5.76	45.00	6.29	47.86	6.68	53.75	7.67	59.64	8.78
	0(32)	30.36	4.12	36.25	4.93	42.14	5.85	45.00	6.37	47.86	6.77	53.75	7.75	59.64	8.85
	2(35.6)	30.36	4.18	36.25	4.99	42.14	5.91	45.00	6.47	47.86	6.87	53.75	7.91	59.64	8.98
	4(39.2)	30.36	4.24	36.25	5.07	42.14	6.01	45.00	6.55	47.86	6.96	53.75	8.04	59.64	9.11
	6(42.8)	30.36	4.30	36.25	5.17	42.14	6.12	45.00	6.68	47.86	7.08	53.75	8.16	59.64	9.26
	8(46.4)	30.36	4.38	36.25	5.27	42.14	6.24	45.00	6.76	47.86	7.21	53.75	8.31	59.64	9.35
	10(50)	30.36	4.47	36.25	5.38	42.14	6.36	45.00	6.86	47.86	7.37	53.75	8.42	59.64	9.50
	12(53.6)	30.36	4.54	36.25	5.48	42.14	6.47	45.00	6.98	47.86	7.51	53.75	8.58	59.64	9.67
	14(57.2)	30.36	4.62	36.25	5.58	42.14	6.59	45.00	7.12	47.86	7.64	53.75	8.74	59.64	9.85
	16(60.8)	30.36	4.70	36.25	5.67	42.14	6.73	45.00	7.25	47.86	7.80	53.75	8.91	59.46	10.02
	18(64.4)	30.36	4.78	36.25	5.79	42.14	6.84	45.00	7.39	47.86	7.96	53.75	9.09	58.75	10.34
	20(68)	30.36	4.87	36.25	5.92	42.14	6.98	45.00	7.55	47.86	8.25	53.75	9.77	57.86	10.82
	21(69.8)	30.36	4.91	36.25	5.97	42.14	7.10	45.00	7.80	47.86	8.54	53.75	10.12	57.50	11.08
	23(73.4)	30.36	5.01	36.25	6.20	42.14	7.60	45.00	8.37	47.86	9.16	53.75	10.86	56.61	11.58
	25(77)	30.36	5.28	36.25	6.63	42.14	8.13	45.00	8.95	47.86	9.79	53.75	11.62	55.89	12.09
	27(80.6)	30.36	5.62	36.25	7.06	42.14	8.68	45.00	9.56	47.86	10.47	53.75	12.44	55.00	12.60
	29(84.2)	30.36	5.99	36.25	7.53	42.14	9.26	45.00	10.20	47.86	11.19	53.21	13.01	54.28	13.10
	31(87.8)	30.36	6.36	36.25	8.02	42.14	9.87	45.00	10.88	47.86	11.93	52.32	13.51	53.39	13.63
	33(91.4)	30.36	6.75	36.25	8.52	42.14	10.53	45.00	11.60	47.86	12.73	51.61	14.04	52.68	14.14
35(95)	30.36	7.18	36.25	9.07	42.14	11.21	45.00	12.36	47.86	13.57	50.72	14.55	51.79	14.66	
37(98.6)	30.36	7.60	36.25	9.63	42.14	11.93	45.00	13.16	47.86	14.47	49.82	15.05	51.07	15.17	
39(102.2)	30.36	8.07	36.25	10.26	42.14	12.69	45.00	14.02	47.86	15.41	49.11	15.58	50.18	15.70	
41(105.8)	30.36	8.35	36.25	10.72	42.14	13.16	45.00	14.39	47.86	15.50	48.77	15.98	49.84	16.07	
43(109.4)	30.36	8.75	36.25	11.18	42.14	13.62	45.00	14.76	47.86	15.83	48.52	16.19	49.41	16.32	
45(113)	30.36	9.31	36.25	11.74	42.14	14.18	45.00	15.26	47.86	16.27	48.25	16.35	48.66	16.54	
48(118.4)	30.36	10.05	36.25	12.48	42.14	14.92	45.00	16.00	47.86	16.63	48.06	16.69	48.29	16.81	
80%	-5(23)	26.96	3.54	32.14	4.19	37.32	4.96	40.00	5.27	42.68	5.68	47.86	6.56	53.04	7.49
	-2(28.4)	26.96	3.59	32.14	4.24	37.32	5.00	40.00	5.35	42.68	5.73	47.86	6.62	53.04	7.56
	0(32)	26.96	3.66	32.14	4.29	37.32	5.06	40.00	5.42	42.68	5.83	47.86	6.72	53.04	7.66
	2(35.6)	26.96	3.73	32.14	4.35	37.32	5.13	40.00	5.52	42.68	5.94	47.86	6.85	53.04	7.81
	4(39.2)	26.96	3.79	32.14	4.43	37.32	5.23	40.00	5.64	42.68	6.04	47.86	6.98	53.04	7.91
	6(42.8)	26.96	3.85	32.14	4.53	37.32	5.31	40.00	5.77	42.68	6.15	47.86	7.08	53.04	8.05
	8(46.4)	26.96	3.93	32.14	4.63	37.32	5.44	40.00	5.86	42.68	6.29	47.86	7.19	53.04	8.21
	10(50)	26.96	3.96	32.14	4.74	37.32	5.58	40.00	6.01	42.68	6.44	47.86	7.35	53.04	8.29
	12(53.6)	26.96	4.02	32.14	4.82	37.32	5.67	40.00	6.12	42.68	6.57	47.86	7.49	53.04	8.44
	14(57.2)	26.96	4.10	32.14	4.91	37.32	5.77	40.00	6.22	42.68	6.69	47.86	7.63	53.04	8.60
	16(60.8)	26.96	4.15	32.14	4.99	37.32	5.89	40.00	6.34	42.68	6.81	47.86	7.78	53.04	8.76
	18(64.4)	26.96	4.23	32.14	5.09	37.32	6.01	40.00	6.47	42.68	6.94	47.86	7.94	53.04	8.93
	20(68)	26.96	4.31	32.14	5.19	37.32	6.12	40.00	6.59	42.68	7.08	47.86	8.23	53.04	9.56
	21(69.8)	26.96	4.35	32.14	5.23	37.32	6.18	40.00	6.67	42.68	7.24	47.86	8.52	53.04	9.91
	23(73.4)	26.96	4.43	32.14	5.34	37.32	6.47	40.00	7.10	42.68	7.74	47.86	9.13	53.04	10.63
	25(77)	26.96	4.56	32.14	5.67	37.32	6.92	40.00	7.59	42.68	8.27	47.86	9.77	53.04	11.37
	27(80.6)	26.96	4.86	32.14	6.05	37.32	7.37	40.00	8.09	42.68	8.83	47.86	10.43	53.04	12.17
	29(84.2)	26.96	5.17	32.14	6.44	37.32	7.86	40.00	8.62	42.68	9.44	47.86	11.14	53.04	13.01
	31(87.8)	26.96	5.48	32.14	6.85	37.32	8.37	40.00	9.19	42.68	10.06	47.86	11.90	52.14	13.52
	33(91.4)	26.96	5.83	32.14	7.27	37.32	8.91	40.00	9.79	42.68	10.71	47.86	12.68	51.43	14.02
35(95)	26.96	6.18	32.14	7.74	37.32	9.48	40.00	10.41	42.68	11.41	47.86	13.52	50.54	14.53	
37(98.6)	26.96	6.55	32.14	8.21	37.32	10.08	40.00	11.10	42.68	12.15	47.86	14.41	49.82	15.04	
39(102.2)	26.96	6.94	32.14	8.76	37.32	10.73	40.00	11.80	42.68	12.93	47.86	15.35	48.93	15.56	
41(105.8)	26.96	7.10	32.14	8.83	37.32	10.88	40.00	12.11	42.68	13.16	47.86	15.74	48.63	15.84	
43(109.4)	26.96	7.31	32.14	8.91	37.32	11.04	40.00	12.32	42.68	13.35	47.86	15.92	48.33	16.01	
45(113)	26.96	7.52	32.14	9.02	37.32	11.25	40.00	12.58	42.68	13.58	47.86	16.10	47.73	16.27	
48(118.4)	26.96	7.67	32.14	9.17	37.32	11.58	40.00	13.05	42.68	13.96	47.86	16.46	47.33	16.82	

**Cooling capacity table**

**MVD-V5X500W/V2GN1**

TC: Total Capacity (kW); PI: Power Input (kW) (Compressor + Outdoor fan motor)

Combination (%)	Outdoor temperature (°C(°F) DB)	Indoor temperature(°C(°F))													
		DB:20.8(69.4) WB:14(57.2)		DB:23.3(73.9) WB:16(60.8)		DB:25.8(78.4) WB:18(64.4)		DB:27(80.6) WB:19(66.2)		DB:28.2(82.8) WB:20(68)		DB:30.7(87.3) WB:22(71.6)		DB:32(89.6) WB:24(75.2)	
		TC	PI	TC	PI	TC	PI	TC	PI	TC	PI	TC	PI	TC	PI
		kW	kW	kW	kW	kW	kW	kW	kW	kW	kW	kW	kW	kW	kW
70%	-5(23)	23.57	3.16	28.21	3.71	32.68	4.20	35.00	4.50	37.32	4.81	41.79	5.50	46.43	6.32
	-2(28.4)	23.57	3.19	28.21	3.72	32.68	4.23	35.00	4.59	37.32	4.89	41.79	5.58	46.43	6.41
	0(32)	23.57	3.20	28.21	3.78	32.68	4.31	35.00	4.68	37.32	4.98	41.79	5.70	46.43	6.49
	2(35.6)	23.57	3.22	28.21	3.79	32.68	4.38	35.00	4.76	37.32	5.07	41.79	5.82	46.43	6.60
	4(39.2)	23.57	3.26	28.21	3.89	32.68	4.48	35.00	4.85	37.32	5.18	41.79	5.91	46.43	6.75
	6(42.8)	23.57	3.32	28.21	3.96	32.68	4.59	35.00	5.00	37.32	5.30	41.79	6.02	46.43	6.88
	8(46.4)	23.57	3.38	28.21	4.07	32.68	4.69	35.00	5.08	37.32	5.41	41.79	6.19	46.43	7.01
	10(50)	23.57	3.45	28.21	4.13	32.68	4.82	35.00	5.19	37.32	5.56	41.79	6.32	46.43	7.10
	12(53.6)	23.57	3.53	28.21	4.19	32.68	4.91	35.00	5.29	37.32	5.66	41.79	6.44	46.43	7.24
	14(57.2)	23.57	3.59	28.21	4.27	32.68	4.99	35.00	5.36	37.32	5.75	41.79	6.55	46.43	7.37
	16(60.8)	23.57	3.65	28.21	4.35	32.68	5.09	35.00	5.48	37.32	5.87	41.79	6.67	46.43	7.51
	18(64.4)	23.57	3.71	28.21	4.43	32.68	5.19	35.00	5.58	37.32	5.97	41.79	6.81	46.43	7.66
	20(68)	23.57	3.76	28.21	4.51	32.68	5.29	35.00	5.68	37.32	6.08	41.79	6.94	46.43	7.88
	21(69.8)	23.57	3.80	28.21	4.54	32.68	5.32	35.00	5.73	37.32	6.14	41.79	7.04	46.43	8.15
	23(73.4)	23.57	3.86	28.21	4.62	32.68	5.44	35.00	5.93	37.32	6.46	41.79	7.55	46.43	8.74
	25(77)	23.57	3.94	28.21	4.82	32.68	5.79	35.00	6.34	37.32	6.88	41.79	8.07	46.43	9.34
	27(80.6)	23.57	4.17	28.21	5.13	32.68	6.18	35.00	6.75	37.32	7.35	41.79	8.62	46.43	9.99
	29(84.2)	23.57	4.43	28.21	5.44	32.68	6.57	35.00	7.20	37.32	7.82	41.79	9.19	46.43	10.67
	31(87.8)	23.57	4.68	28.21	5.77	32.68	7.00	35.00	7.64	37.32	8.33	41.79	9.79	46.43	11.37
	33(91.4)	23.57	4.97	28.21	6.14	32.68	7.45	35.00	8.13	37.32	8.87	41.79	10.43	46.43	12.13
35(95)	23.57	5.27	28.21	6.51	32.68	7.90	35.00	8.66	37.32	9.44	41.79	11.12	46.43	12.93	
37(98.6)	23.57	5.56	28.21	6.90	32.68	8.41	35.00	9.19	37.32	10.04	41.79	11.84	46.43	13.77	
39(102.2)	23.57	5.89	28.21	7.31	32.68	8.91	35.00	9.77	37.32	10.67	41.79	12.58	46.43	14.67	
41(105.8)	23.57	6.15	28.21	7.57	32.68	9.17	35.00	10.10	37.32	10.99	41.79	13.10	46.43	15.31	
43(109.4)	23.57	6.65	28.21	8.09	32.68	9.55	35.00	10.64	37.32	11.32	41.79	13.57	46.43	15.79	
45(113)	23.57	6.80	28.21	8.27	32.68	9.75	35.00	10.81	37.32	11.88	41.79	14.31	46.43	16.40	
48(118.4)	23.57	7.24	28.21	8.79	32.68	10.35	35.00	11.33	37.32	12.23	41.79	14.74	46.43	16.74	
60%	-5(23)	20.18	2.70	24.11	3.13	28.04	3.64	30.00	3.88	31.97	4.19	35.89	4.71	39.82	5.40
	-2(28.4)	20.18	2.71	24.11	3.18	28.04	3.71	30.00	3.94	31.97	4.24	35.89	4.78	39.82	5.44
	0(32)	20.18	2.75	24.11	3.22	28.04	3.76	30.00	3.99	31.97	4.31	35.89	4.85	39.82	5.51
	2(35.6)	20.18	2.80	24.11	3.29	28.04	3.83	30.00	4.07	31.97	4.36	35.89	4.95	39.82	5.58
	4(39.2)	20.18	2.88	24.11	3.35	28.04	3.90	30.00	4.12	31.97	4.43	35.89	5.03	39.82	5.65
	6(42.8)	20.18	2.91	24.11	3.42	28.04	3.98	30.00	4.21	31.97	4.52	35.89	5.13	39.82	5.79
	8(46.4)	20.18	2.96	24.11	3.47	28.04	4.05	30.00	4.29	31.97	4.61	35.89	5.22	39.82	5.88
	10(50)	20.18	3.02	24.11	3.55	28.04	4.11	30.00	4.41	31.97	4.70	35.89	5.32	39.82	5.97
	12(53.6)	20.18	3.08	24.11	3.61	28.04	4.19	30.00	4.48	31.97	4.78	35.89	5.42	39.82	6.06
	14(57.2)	20.18	3.12	24.11	3.67	28.04	4.25	30.00	4.56	31.97	4.87	35.89	5.52	39.82	6.18
	16(60.8)	20.18	3.16	24.11	3.72	28.04	4.33	30.00	4.64	31.97	4.95	35.89	5.62	39.82	6.30
	18(64.4)	20.18	3.22	24.11	3.78	28.04	4.41	30.00	4.72	31.97	5.05	35.89	5.71	39.82	6.41
	20(68)	20.18	3.26	24.11	3.86	28.04	4.48	30.00	4.82	31.97	5.15	35.89	5.83	39.82	6.55
	21(69.8)	20.18	3.30	24.11	3.88	28.04	4.52	30.00	4.85	31.97	5.19	35.89	5.89	39.82	6.61
	23(73.4)	20.18	3.33	24.11	3.96	28.04	4.60	30.00	4.95	31.97	5.28	35.89	6.12	39.82	7.04
	25(77)	20.18	3.39	24.11	4.02	28.04	4.78	30.00	5.19	31.97	5.62	35.89	6.53	39.82	7.51
	27(80.6)	20.18	3.53	24.11	4.27	28.04	5.09	30.00	5.54	31.97	5.99	35.89	6.96	39.82	8.01
	29(84.2)	20.18	3.72	24.11	4.52	28.04	5.42	30.00	5.89	31.97	6.38	35.89	7.43	39.82	8.56
	31(87.8)	20.18	3.96	24.11	4.80	28.04	5.75	30.00	6.26	31.97	6.79	35.89	7.90	39.82	9.11
	33(91.4)	20.18	4.17	24.11	5.09	28.04	6.10	30.00	6.65	31.97	7.21	35.89	8.40	39.82	9.71
35(95)	20.18	4.43	24.11	5.40	28.04	6.47	30.00	7.06	31.97	7.66	35.89	8.95	39.82	10.33	
37(98.6)	20.18	4.68	24.11	5.71	28.04	6.86	30.00	7.49	31.97	8.13	35.89	9.52	39.82	11.00	
39(102.2)	20.18	4.93	24.11	6.04	28.04	7.27	30.00	7.94	31.97	8.64	35.89	10.10	39.82	11.70	
41(105.8)	20.18	5.09	24.11	6.31	28.04	7.54	30.00	8.25	31.97	8.96	35.89	10.58	39.82	12.23	
43(109.4)	20.18	5.25	24.11	6.57	28.04	7.80	30.00	8.50	31.97	9.27	35.89	11.03	39.82	12.76	
45(113)	20.18	5.50	24.11	6.90	28.04	8.12	30.00	8.82	31.97	9.73	35.89	11.52	39.82	13.46	
48(118.4)	20.18	5.92	24.11	7.37	28.04	8.54	30.00	9.35	31.97	10.48	35.89	12.13	39.82	14.52	

**Cooling capacity table**

**MVD-V5X500W/V2GN1**

TC: Total Capacity (kW); PI: Power Input (kW) (Compressor + Outdoor fan motor)

Combination (%)	Outdoor temperature (°C(°F) DB)	Indoor temperature(°C(°F))													
		DB:20.8(69.4) WB:14(57.2)		DB:23.3(73.9) WB:16(60.8)		DB:25.8(78.4) WB:18(64.4)		DB:27(80.6) WB:19(66.2)		DB:28.2(82.8) WB:20(68)		DB:30.7(87.3) WB:22(71.6)		DB:32(89.6) WB:24(75.2)	
		TC	PI	TC	PI	TC	PI	TC	PI	TC	PI	TC	PI	TC	PI
		kW	kW	kW	kW	kW	kW	kW	kW	kW	kW	kW	kW	kW	kW
50%	-5(23)	16.88	2.34	20.18	2.71	23.39	3.11	25.00	3.26	26.61	3.44	29.82	3.91	33.22	4.21
	-2(28.4)	16.88	2.36	20.18	2.76	23.39	3.14	25.00	3.30	26.61	3.50	29.82	3.96	33.22	4.27
	0(32)	16.88	2.40	20.18	2.81	23.39	3.20	25.00	3.35	26.61	3.54	29.82	4.03	33.22	4.34
	2(35.6)	16.88	2.43	20.18	2.84	23.39	3.26	25.00	3.40	26.61	3.60	29.82	4.04	33.22	4.43
	4(39.2)	16.88	2.46	20.18	2.89	23.39	3.29	25.00	3.44	26.61	3.67	29.82	4.14	33.22	4.54
	6(42.8)	16.88	2.50	20.18	2.94	23.39	3.34	25.00	3.52	26.61	3.74	29.82	4.21	33.22	4.67
	8(46.4)	16.88	2.56	20.18	2.99	23.39	3.40	25.00	3.59	26.61	3.79	29.82	4.28	33.22	4.82
	10(50)	16.88	2.61	20.18	3.02	23.39	3.45	25.00	3.65	26.61	3.90	29.82	4.39	33.22	4.89
	12(53.6)	16.88	2.63	20.18	3.06	23.39	3.51	25.00	3.72	26.61	3.98	29.82	4.47	33.22	4.97
	14(57.2)	16.88	2.67	20.18	3.10	23.39	3.55	25.00	3.80	26.61	4.04	29.82	4.54	33.22	5.07
	16(60.8)	16.88	2.71	20.18	3.14	23.39	3.61	25.00	3.86	26.61	4.10	29.82	4.62	33.22	5.15
	18(64.4)	16.88	2.75	20.18	3.20	23.39	3.67	25.00	3.92	26.61	4.17	29.82	4.70	33.22	5.25
	20(68)	16.88	2.79	20.18	3.24	23.39	3.72	25.00	3.98	26.61	4.25	29.82	4.78	33.22	5.34
	21(69.8)	16.88	2.81	20.18	3.28	23.39	3.76	25.00	4.02	26.61	4.29	29.82	4.84	33.22	5.40
	23(73.4)	16.88	2.85	20.18	3.32	23.39	3.82	25.00	4.10	26.61	4.37	29.82	4.91	33.22	5.52
	25(77)	16.88	2.89	20.18	3.37	23.39	3.90	25.00	4.17	26.61	4.50	29.82	5.17	33.22	5.89
	27(80.6)	16.88	2.94	20.18	3.51	23.39	4.11	25.00	4.45	26.61	4.78	29.82	5.50	33.22	6.28
	29(84.2)	16.88	3.10	20.18	3.70	23.39	4.37	25.00	4.72	26.61	5.09	29.82	5.85	33.22	6.69
	31(87.8)	16.88	3.28	20.18	3.92	23.39	4.62	25.00	5.01	26.61	5.40	29.82	6.22	33.22	7.12
	33(91.4)	16.88	3.47	20.18	4.15	23.39	4.91	25.00	5.30	26.61	5.73	29.82	6.61	33.22	7.57
35(95)	16.88	3.67	20.18	4.39	23.39	5.19	25.00	5.62	26.61	6.07	29.82	7.02	33.22	8.03	
37(98.6)	16.88	3.86	20.18	4.64	23.39	5.50	25.00	5.95	26.61	6.43	29.82	7.45	33.22	8.54	
39(102.2)	16.88	4.08	20.18	4.89	23.39	5.81	25.00	6.30	26.61	6.82	29.82	7.90	33.22	9.07	
41(105.8)	16.88	4.24	20.18	5.10	23.39	6.02	25.00	6.59	26.61	7.12	29.82	8.32	33.22	9.49	
43(109.4)	16.88	4.52	20.18	5.46	23.39	6.23	25.00	6.89	26.61	7.30	29.82	8.74	33.22	9.91	
45(113)	16.88	4.63	20.18	5.60	23.39	6.65	25.00	7.42	26.61	7.61	29.82	9.58	33.22	10.75	
48(118.4)	16.88	4.94	20.18	6.02	23.39	6.93	25.00	7.76	26.61	7.84	29.82	10.14	33.22	11.31	

**Cooling capacity table**

**MVD-V5X560W/V2GN1**

TC: Total Capacity (kW); PI: Power Input (kW) (Compressor + Outdoor fan motor)

Combination (%)	Outdoor temperature (°C(°F) DB)	Indoor temperature(°C(°F))													
		DB:20.8(69.4) WB:14(57.2)		DB:23.3(73.9) WB:16(60.8)		DB:25.8(78.4) WB:18(64.4)		DB:27(80.6) WB:19(66.2)		DB:28.2(82.8) WB:20(68)		DB:30.7(87.3) WB:22(71.6)		DB:32(89.6) WB:24(75.2)	
		TC	PI	TC	PI	TC	PI	TC	PI	TC	PI	TC	PI	TC	PI
		kW	kW	kW	kW	kW	kW	kW	kW	kW	kW	kW	kW	kW	kW
130%	-5(23)	49.20	6.81	58.60	8.32	67.99	8.92	70.60	9.28	73.99	9.54	75.80	10.38	77.70	10.44
	-2(28.4)	49.20	6.81	58.60	8.48	67.99	8.92	70.60	9.33	73.99	9.54	75.80	10.51	77.70	10.55
	0(32)	49.20	6.93	58.60	8.62	67.99	9.24	70.60	9.84	73.99	10.10	75.80	10.64	77.70	10.69
	2(35.6)	49.20	7.06	58.60	8.64	67.99	9.56	70.60	10.40	73.99	10.21	75.80	10.71	77.70	10.84
	4(39.2)	49.20	7.21	58.60	8.81	67.99	9.89	70.60	10.44	73.99	10.34	75.80	10.71	77.70	11.05
	6(42.8)	49.20	7.35	58.60	8.99	67.99	10.25	70.60	10.53	73.17	10.67	74.87	10.71	76.85	11.13
	8(46.4)	49.20	7.53	58.60	9.19	67.99	10.77	70.60	11.05	72.26	11.01	74.06	3.90	75.87	11.24
	10(50)	49.20	7.68	58.60	9.39	67.99	11.17	70.60	11.41	71.40	4.04	73.20	4.06	75.00	11.57
	12(53.6)	49.20	7.82	58.60	9.57	67.99	11.39	69.60	4.03	70.60	4.06	72.20	4.07	74.00	11.64
	14(57.2)	49.20	7.98	58.60	9.75	67.80	4.05	68.80	4.06	69.60	4.08	71.40	4.09	73.20	11.90
	16(60.8)	49.20	8.11	58.60	9.95	67.00	4.06	67.80	4.08	68.60	4.10	70.40	4.12	72.20	12.09
	18(64.4)	49.20	8.27	58.60	10.16	66.00	11.91	66.80	11.98	67.80	12.04	69.60	12.16	71.40	12.27
	20(68)	49.20	8.45	58.60	10.81	65.00	12.49	66.00	12.56	66.80	12.63	68.60	12.74	70.40	12.87
	21(69.8)	49.20	8.67	58.60	11.19	64.60	12.79	65.60	12.85	66.40	12.92	68.20	13.05	70.00	13.17
	23(73.4)	49.20	9.30	58.60	12.00	63.80	13.37	64.60	13.43	65.40	13.50	67.20	13.64	68.99	13.77
	25(77)	49.20	9.93	58.60	12.85	62.80	13.95	63.60	14.02	64.60	14.11	66.40	14.24	68.20	14.38
	27(80.6)	49.20	10.60	58.60	13.75	62.00	14.54	62.80	14.63	63.60	14.69	65.40	14.85	67.20	15.01
	29(84.2)	49.20	11.32	58.60	14.69	61.00	15.12	61.80	15.21	62.80	15.30	64.60	15.46	66.40	15.62
	31(87.8)	49.20	12.09	58.40	15.55	60.00	15.73	61.00	15.82	61.80	15.88	63.60	16.06	65.40	16.24
	33(91.4)	49.20	12.87	57.40	16.13	59.20	16.31	60.00	16.40	61.00	16.49	62.80	16.67	64.40	16.85
35(95)	49.20	13.73	56.40	16.72	58.20	16.92	59.20	17.01	60.00	17.10	61.80	17.30	63.60	17.48	
37(98.6)	49.20	14.61	55.60	17.32	57.40	17.53	58.20	17.62	59.20	17.73	60.80	17.93	62.60	18.13	
39(102.2)	49.20	15.55	54.60	17.50	56.40	18.11	57.40	18.22	58.20	18.33	60.00	18.54	61.80	18.76	
41(105.8)	49.20	16.36	54.03	17.67	55.81	18.28	56.81	18.39	57.61	18.50	59.40	18.57	59.43	18.93	
43(109.4)	49.20	16.78	53.64	17.76	55.51	18.33	56.51	18.48	57.01	18.53	58.32	18.61	58.72	18.97	
45(113)	49.20	17.61	53.30	17.93	54.92	18.50	55.92	18.60	56.18	18.61	56.74	18.68	57.57	19.33	
48(118.4)	49.20	18.87	53.13	18.18	54.03	18.86	55.03	18.70	55.47	18.79	55.23	18.78	56.24	20.27	
120%	-5(23)	45.40	6.58	54.00	7.97	62.80	9.43	67.20	10.28	70.40	10.72	72.00	11.06	73.60	11.35
	-2(28.4)	45.40	6.65	54.00	8.06	62.80	9.52	67.20	10.34	70.40	10.84	72.00	11.15	73.60	11.39
	0(32)	45.40	6.71	54.00	8.11	62.80	9.63	67.20	10.37	70.40	10.94	72.00	11.22	73.60	11.42
	2(35.6)	45.40	6.72	54.00	8.19	62.80	9.70	67.20	10.46	70.40	10.98	72.00	11.30	73.60	11.44
	4(39.2)	45.40	6.79	54.00	8.30	62.80	9.83	67.20	10.56	70.40	11.13	72.00	11.32	73.60	11.47
	6(42.8)	45.40	6.86	54.00	8.36	62.80	9.95	67.20	10.68	70.40	11.25	72.00	11.42	73.60	11.51
	8(46.4)	45.40	6.93	54.00	8.45	62.80	10.09	67.20	10.81	70.40	11.36	72.00	11.45	73.60	11.56
	10(50)	45.40	7.01	54.00	8.56	62.80	10.18	67.20	11.01	70.40	11.37	72.00	11.49	73.60	11.61
	12(53.6)	45.40	7.14	54.00	8.72	62.80	10.38	67.20	11.21	69.40	11.42	71.00	11.42	72.60	11.69
	14(57.2)	45.40	7.28	54.00	8.90	62.80	10.58	67.20	11.44	68.40	11.49	70.20	11.60	71.80	11.83
	16(60.8)	45.40	7.41	54.00	9.08	62.80	10.78	66.80	4.10	67.60	11.66	69.20	11.79	70.80	12.01
	18(64.4)	45.40	7.55	54.00	9.26	62.80	11.14	65.80	11.91	66.60	11.95	68.20	12.06	70.00	12.18
	20(68)	45.40	7.71	54.00	9.61	62.80	12.00	65.00	12.49	65.80	12.54	67.40	12.65	69.00	12.76
	21(69.8)	45.40	7.77	54.00	9.95	62.80	12.42	64.40	12.78	65.20	12.83	67.00	12.94	68.60	13.08
	23(73.4)	45.40	8.31	54.00	10.67	62.80	13.30	63.60	13.35	64.40	13.41	66.00	13.55	67.60	13.66
	25(77)	45.40	8.87	54.00	11.41	61.80	13.88	62.60	13.93	63.40	14.00	65.20	14.13	66.80	14.27
	27(80.6)	45.40	9.48	54.00	12.20	61.00	14.45	61.80	14.54	62.60	14.60	64.20	14.74	65.80	14.87
	29(84.2)	45.40	10.11	54.00	13.03	60.00	15.03	60.80	15.12	61.60	15.19	63.20	15.34	65.00	15.48
	31(87.8)	45.40	10.78	54.00	13.91	59.00	15.64	60.00	15.70	60.80	15.79	62.40	15.95	64.00	16.11
	33(91.4)	45.40	11.48	54.00	14.83	58.20	16.22	59.00	16.31	59.80	16.38	61.40	16.56	63.00	16.72
35(95)	45.40	12.22	54.00	15.82	57.20	16.80	58.00	16.90	59.00	16.98	60.60	17.17	62.20	17.34	
37(98.6)	45.40	13.01	54.00	16.85	56.40	17.41	57.20	17.50	58.00	17.59	59.60	17.77	61.20	17.97	
39(102.2)	45.40	13.84	53.80	17.79	55.40	18.00	56.20	18.11	57.00	18.20	58.80	18.40	60.40	18.58	
41(105.8)	45.40	14.22	53.37	17.92	54.97	18.12	55.77	18.23	56.57	18.32	58.36	18.45	58.66	18.72	
43(109.4)	45.40	14.43	53.08	18.05	54.53	18.23	55.33	18.30	56.13	18.39	57.35	18.50	57.75	19.09	
45(113)	45.40	14.60	52.79	18.22	54.01	18.40	54.75	18.48	55.64	18.53	56.19	18.56	57.17	19.51	
48(118.4)	45.40	14.85	52.34	18.47	53.31	18.63	53.88	18.71	55.03	18.89	55.32	18.91	56.42	19.76	

**Cooling capacity table**

**MVD-V5X560W/V2GN1**

TC: Total Capacity (kW); PI: Power Input (kW) (Compressor + Outdoor fan motor)

Combination (%)	Outdoor temperature (°C(°F) DB)	Indoor temperature(°C(°F))													
		DB:20.8(69.4) WB:14(57.2)		DB:23.3(73.9) WB:16(60.8)		DB:25.8(78.4) WB:18(64.4)		DB:27(80.6) WB:19(66.2)		DB:28.2(82.8) WB:20(68)		DB:30.7(87.3) WB:22(71.6)		DB:32(89.6) WB:24(75.2)	
		TC	PI	TC	PI	TC	PI	TC	PI	TC	PI	TC	PI	TC	PI
		kW	kW	kW	kW	kW	kW	kW	kW	kW	kW	kW	kW	kW	kW
110%	-5(23)	41.60	5.75	49.60	7.15	57.60	8.54	61.60	9.16	65.60	9.86	70.60	10.24	72.20	10.56
	-2(28.4)	41.60	5.86	49.60	7.25	57.60	8.61	61.60	9.26	65.60	9.94	70.60	10.34	72.20	10.61
	0(32)	41.60	5.92	49.60	7.29	57.60	8.68	61.60	9.31	65.60	10.05	70.60	10.44	72.20	10.74
	2(35.6)	41.60	6.05	49.60	7.36	57.60	8.81	61.60	9.42	65.60	10.16	70.60	10.59	72.20	10.88
	4(39.2)	41.60	6.17	49.60	7.44	57.60	8.90	61.60	9.53	65.60	10.31	70.60	10.74	72.20	10.98
	6(42.8)	41.60	6.23	49.60	7.53	57.60	8.98	61.60	9.68	65.60	10.43	70.60	10.85	72.20	11.14
	8(46.4)	41.60	6.28	49.60	7.65	57.60	9.08	61.60	9.78	65.60	10.54	70.60	10.93	72.20	11.26
	10(50)	41.60	6.36	49.60	7.75	57.60	9.21	61.60	9.95	65.60	10.72	70.60	11.00	72.20	11.36
	12(53.6)	41.60	6.49	49.60	7.91	57.60	9.39	61.60	10.16	65.60	10.92	69.81	11.17	71.20	11.51
	14(57.2)	41.60	6.61	49.60	8.04	57.60	9.57	61.60	10.34	65.60	11.12	68.80	11.26	70.40	11.59
	16(60.8)	41.60	6.72	49.60	8.20	57.60	9.75	61.60	10.54	65.60	11.35	68.00	11.39	69.40	11.71
	18(64.4)	41.60	6.85	49.60	8.36	57.60	9.95	61.60	10.83	65.60	11.89	67.00	11.97	68.60	12.09
	20(68)	41.60	6.99	49.60	8.54	57.60	10.54	61.60	11.64	64.60	12.47	66.20	12.56	67.60	12.67
	21(69.8)	41.60	7.05	49.60	8.78	57.60	10.92	61.60	12.07	64.20	12.76	65.60	12.85	67.20	12.96
	23(73.4)	41.60	7.39	49.60	9.41	57.60	11.71	61.60	12.94	63.20	13.32	64.81	13.46	66.20	13.57
	25(77)	41.60	7.89	49.60	10.06	57.60	12.51	61.60	13.86	62.40	13.91	63.80	14.04	65.40	14.16
	27(80.6)	41.60	8.40	49.60	10.76	57.60	13.39	60.60	14.45	61.40	14.49	63.00	14.63	64.40	14.76
	29(84.2)	41.60	8.96	49.60	11.48	57.60	14.31	59.80	15.03	60.60	15.10	62.00	15.23	63.60	15.37
	31(87.8)	41.60	9.55	49.60	12.25	57.60	15.28	58.80	15.62	59.60	15.68	61.20	15.82	62.60	15.97
	33(91.4)	41.60	10.16	49.60	13.05	57.20	16.11	58.00	16.20	58.80	16.27	60.20	16.42	61.80	16.58
35(95)	41.60	10.81	49.60	13.91	56.20	16.69	57.00	16.78	57.80	16.87	59.20	17.03	60.80	17.19	
37(98.6)	41.60	11.50	49.60	14.81	55.40	17.30	56.20	17.37	56.80	17.46	58.40	17.64	59.80	17.79	
39(102.2)	41.60	12.22	49.60	15.77	54.40	17.88	55.20	17.97	56.00	18.06	57.40	18.24	59.00	18.42	
41(105.8)	41.60	12.35	49.60	15.90	53.98	18.01	54.77	18.10	55.58	18.19	56.67	18.37	57.23	18.55	
43(109.4)	41.60	12.47	49.60	16.10	53.55	18.14	54.35	18.23	55.15	18.32	56.17	18.44	56.35	18.93	
45(113)	41.60	12.88	49.60	16.19	53.01	18.30	53.78	18.45	54.66	18.48	55.60	18.94	55.82	19.37	
48(118.4)	41.60	13.20	49.60	16.44	52.24	18.56	52.92	18.74	54.04	18.85	54.68	19.68	55.10	20.37	
100%	-5(23)	37.80	5.23	45.00	6.30	52.40	7.50	56.00	8.03	59.60	8.72	67.00	9.94	70.80	10.37
	-2(28.4)	37.80	5.30	45.00	6.38	52.40	7.58	56.00	8.18	59.60	8.84	67.00	10.05	70.80	10.44
	0(32)	37.80	5.35	45.00	6.45	52.40	7.67	56.00	8.28	59.60	8.92	67.00	10.22	70.80	10.55
	2(35.6)	37.80	5.46	45.00	6.54	52.40	7.75	56.00	8.39	59.60	9.02	67.00	10.37	70.80	10.72
	4(39.2)	37.80	5.50	45.00	6.60	52.40	7.87	56.00	8.52	59.60	9.14	67.00	10.47	70.80	10.84
	6(42.8)	37.80	5.58	45.00	6.73	52.40	7.97	56.00	8.67	59.60	9.27	67.00	10.62	70.80	11.00
	8(46.4)	37.80	5.68	45.00	6.83	52.40	8.11	56.00	8.77	59.60	9.42	67.00	10.79	70.80	11.19
	10(50)	37.80	5.75	45.00	6.96	52.40	8.24	56.00	8.92	59.60	9.59	67.00	10.96	70.80	11.35
	12(53.6)	37.80	5.84	45.00	7.10	52.40	8.40	56.00	9.08	59.60	9.77	67.00	11.17	69.80	11.43
	14(57.2)	37.80	5.95	45.00	7.23	52.40	8.56	56.00	9.26	59.60	9.95	67.00	11.39	69.00	11.57
	16(60.8)	37.80	6.07	45.00	7.37	52.40	8.74	56.00	9.44	59.60	10.16	66.60	11.53	68.00	11.71
	18(64.4)	37.80	6.18	45.00	7.50	52.40	8.90	56.00	9.62	59.60	10.36	65.80	11.91	67.20	12.00
	20(68)	37.80	6.29	45.00	7.66	52.40	9.17	56.00	10.11	59.60	11.10	64.80	12.47	66.20	12.58
	21(69.8)	37.80	6.36	45.00	7.73	52.40	9.50	56.00	10.47	59.60	11.48	64.40	12.76	65.80	12.87
	23(73.4)	37.80	6.51	45.00	8.24	52.40	10.18	56.00	11.21	59.60	12.31	63.60	13.34	64.80	13.46
	25(77)	37.80	6.94	45.00	8.81	52.40	10.90	56.00	12.02	59.60	13.19	62.60	13.93	64.00	14.04
	27(80.6)	37.80	7.41	45.00	9.39	52.40	11.64	56.00	12.85	59.60	14.11	61.60	14.51	63.00	14.65
	29(84.2)	37.80	7.88	45.00	10.02	52.40	12.42	56.00	13.73	59.40	14.98	60.80	15.12	62.20	15.23
	31(87.8)	37.80	8.40	45.00	10.69	52.40	13.25	56.00	14.65	58.60	15.57	59.80	15.70	61.20	15.84
	33(91.4)	37.80	8.92	45.00	11.39	52.40	14.13	56.00	15.64	57.60	16.15	59.00	16.29	60.40	16.44
35(95)	37.80	9.48	45.00	12.11	52.40	15.07	56.00	16.67	56.60	16.74	58.00	16.89	59.40	17.03	
37(98.6)	37.80	10.09	45.00	12.90	52.40	16.06	54.99	17.25	55.80	17.34	57.20	17.50	58.40	17.64	
39(102.2)	37.80	10.72	45.00	13.70	52.40	17.10	54.20	17.84	54.80	17.93	56.20	18.09	57.60	18.27	
41(105.8)	37.80	11.22	45.00	14.20	52.40	17.72	53.36	17.96	54.38	18.20	55.55	18.51	56.76	18.64	
43(109.4)	37.80	11.72	45.00	14.70	52.40	18.05	52.52	18.17	53.98	18.38	55.22	18.63	55.76	18.85	
45(113)	37.80	12.38	45.00	15.37	52.40	18.36	52.47	18.42	53.70	18.71	54.64	18.92	55.09	19.10	
48(118.4)	37.80	13.38	45.00	16.37	52.40	18.67	52.43	18.92	53.62	19.42	54.20	19.46	54.76	19.60	

**Cooling capacity table**

**MVD-V5X560W/V2GN1**

TC: Total Capacity (kW); PI: Power Input (kW) (Compressor + Outdoor fan motor)

Combination (%)	Outdoor temperature (°C(°F) DB)	Indoor temperature(°C(°F))													
		DB:20.8(69.4) WB:14(57.2)		DB:23.3(73.9) WB:16(60.8)		DB:25.8(78.4) WB:18(64.4)		DB:27(80.6) WB:19(66.2)		DB:28.2(82.8) WB:20(68)		DB:30.7(87.3) WB:22(71.6)		DB:32(89.6) WB:24(75.2)	
		TC	PI	TC	PI	TC	PI	TC	PI	TC	PI	TC	PI	TC	PI
		kW	kW	kW	kW	kW	kW	kW	kW	kW	kW	kW	kW	kW	kW
90%	-5(23)	34.00	4.63	40.60	5.55	47.20	6.55	50.40	7.15	53.60	7.61	60.20	8.75	66.80	10.01
	-2(28.4)	34.00	4.67	40.60	5.61	47.20	6.64	50.40	7.25	53.60	7.70	60.20	8.83	66.80	10.11
	0(32)	34.00	4.74	40.60	5.68	47.20	6.74	50.40	7.34	53.60	7.80	60.20	8.93	66.80	10.19
	2(35.6)	34.00	4.81	40.60	5.75	47.20	6.81	50.40	7.45	53.60	7.92	60.20	9.12	66.80	10.34
	4(39.2)	34.00	4.89	40.60	5.84	47.20	6.92	50.40	7.55	53.60	8.02	60.20	9.26	66.80	10.49
	6(42.8)	34.00	4.95	40.60	5.95	47.20	7.05	50.40	7.69	53.60	8.16	60.20	9.40	66.80	10.67
	8(46.4)	34.00	5.05	40.60	6.07	47.20	7.19	50.40	7.79	53.60	8.30	60.20	9.58	66.80	10.77
	10(50)	34.00	5.14	40.60	6.20	47.20	7.32	50.40	7.91	53.60	8.49	60.20	9.70	66.80	10.94
	12(53.6)	34.00	5.23	40.60	6.31	47.20	7.46	50.40	8.04	53.60	8.65	60.20	9.88	66.80	11.14
	14(57.2)	34.00	5.32	40.60	6.42	47.20	7.59	50.40	8.20	53.60	8.81	60.20	10.06	66.80	11.34
	16(60.8)	34.00	5.41	40.60	6.54	47.20	7.75	50.40	8.36	53.60	8.99	60.20	10.27	66.60	11.55
	18(64.4)	34.00	5.50	40.60	6.67	47.20	7.88	50.40	8.51	53.60	9.17	60.20	10.47	65.80	11.91
	20(68)	34.00	5.62	40.60	6.83	47.20	8.04	50.40	8.69	53.60	9.50	60.20	11.25	64.80	12.47
	21(69.8)	34.00	5.66	40.60	6.87	47.20	8.18	50.40	8.99	53.60	9.84	60.20	11.66	64.40	12.76
	23(73.4)	34.00	5.77	40.60	7.14	47.20	8.76	50.40	9.64	53.60	10.56	60.20	12.51	63.40	13.34
	25(77)	34.00	6.09	40.60	7.64	47.20	9.37	50.40	10.31	53.60	11.28	60.20	13.39	62.60	13.93
	27(80.6)	34.00	6.47	40.60	8.13	47.20	10.00	50.40	11.01	53.60	12.06	60.20	14.33	61.60	14.51
	29(84.2)	34.00	6.90	40.60	8.67	47.20	10.67	50.40	11.75	53.60	12.90	59.60	14.98	60.80	15.10
	31(87.8)	34.00	7.32	40.60	9.23	47.20	11.37	50.40	12.54	53.60	13.75	58.60	15.57	59.80	15.70
	33(91.4)	34.00	7.77	40.60	9.82	47.20	12.13	50.40	13.37	53.60	14.67	57.80	16.17	59.00	16.29
35(95)	34.00	8.27	40.60	10.45	47.20	12.92	50.40	14.24	53.60	15.64	56.80	16.76	58.00	16.89	
37(98.6)	34.00	8.76	40.60	11.10	47.20	13.75	50.40	15.16	53.60	16.67	55.80	17.34	57.20	17.48	
39(102.2)	34.00	9.30	40.60	11.82	47.20	14.62	50.40	16.15	53.60	17.75	55.00	17.95	56.20	18.08	
41(105.8)	34.00	9.62	40.60	12.35	47.20	15.16	50.40	16.58	53.60	17.85	54.62	18.41	55.82	18.51	
43(109.4)	34.00	10.08	40.60	12.89	47.20	15.69	50.40	17.01	53.60	18.24	54.34	18.65	55.34	18.80	
45(113)	34.00	10.72	40.60	13.53	47.20	16.33	50.40	17.58	53.60	18.74	54.04	18.84	54.50	19.05	
48(118.4)	34.00	11.58	40.60	14.38	47.20	17.19	50.40	18.43	53.60	19.16	53.83	19.22	54.08	19.37	
80%	-5(23)	30.20	4.08	36.00	4.82	41.80	5.71	44.80	6.07	47.80	6.54	53.60	7.56	59.40	8.63
	-2(28.4)	30.20	4.14	36.00	4.88	41.80	5.76	44.80	6.17	47.80	6.60	53.60	7.63	59.40	8.71
	0(32)	30.20	4.21	36.00	4.94	41.80	5.83	44.80	6.24	47.80	6.72	53.60	7.74	59.40	8.83
	2(35.6)	30.20	4.30	36.00	5.01	41.80	5.91	44.80	6.36	47.80	6.84	53.60	7.89	59.40	9.00
	4(39.2)	30.20	4.37	36.00	5.10	41.80	6.03	44.80	6.50	47.80	6.96	53.60	8.04	59.40	9.12
	6(42.8)	30.20	4.44	36.00	5.22	41.80	6.12	44.80	6.65	47.80	7.09	53.60	8.16	59.40	9.27
	8(46.4)	30.20	4.52	36.00	5.34	41.80	6.26	44.80	6.75	47.80	7.25	53.60	8.28	59.40	9.45
	10(50)	30.20	4.56	36.00	5.46	41.80	6.43	44.80	6.92	47.80	7.41	53.60	8.47	59.40	9.55
	12(53.6)	30.20	4.63	36.00	5.55	41.80	6.54	44.80	7.05	47.80	7.57	53.60	8.63	59.40	9.73
	14(57.2)	30.20	4.72	36.00	5.66	41.80	6.65	44.80	7.17	47.80	7.71	53.60	8.78	59.40	9.91
	16(60.8)	30.20	4.79	36.00	5.75	41.80	6.78	44.80	7.30	47.80	7.84	53.60	8.96	59.40	10.09
	18(64.4)	30.20	4.88	36.00	5.86	41.80	6.92	44.80	7.46	47.80	8.00	53.60	9.14	59.40	10.29
	20(68)	30.20	4.97	36.00	5.98	41.80	7.05	44.80	7.59	47.80	8.16	53.60	9.48	59.40	11.01
	21(69.8)	30.20	5.01	36.00	6.02	41.80	7.12	44.80	7.68	47.80	8.34	53.60	9.82	59.40	11.41
	23(73.4)	30.20	5.10	36.00	6.16	41.80	7.46	44.80	8.18	47.80	8.92	53.60	10.51	59.40	12.24
	25(77)	30.20	5.26	36.00	6.54	41.80	7.98	44.80	8.74	47.80	9.53	53.60	11.26	59.40	13.10
	27(80.6)	30.20	5.59	36.00	6.96	41.80	8.49	44.80	9.32	47.80	10.18	53.60	12.02	59.40	14.02
	29(84.2)	30.20	5.95	36.00	7.41	41.80	9.05	44.80	9.93	47.80	10.87	53.60	12.83	59.40	14.99
	31(87.8)	30.20	6.31	36.00	7.89	41.80	9.64	44.80	10.58	47.80	11.59	53.60	13.70	58.40	15.57
	33(91.4)	30.20	6.72	36.00	8.38	41.80	10.27	44.80	11.28	47.80	12.33	53.60	14.60	57.60	16.15
35(95)	30.20	7.12	36.00	8.92	41.80	10.92	44.80	12.00	47.80	13.14	53.60	15.57	56.60	16.74	
37(98.6)	30.20	7.55	36.00	9.46	41.80	11.62	44.80	12.78	47.80	14.00	53.60	16.60	55.80	17.32	
39(102.2)	30.20	8.00	36.00	10.09	41.80	12.36	44.80	13.59	47.80	14.90	53.60	17.68	54.80	17.93	
41(105.8)	30.20	8.18	36.00	10.18	41.80	12.54	44.80	13.95	47.80	15.17	53.60	18.13	54.46	18.24	
43(109.4)	30.20	8.42	36.00	10.27	41.80	12.72	44.80	14.19	47.80	15.38	53.60	18.34	54.13	18.44	
45(113)	30.20	8.66	36.00	10.39	41.80	12.96	44.80	14.49	47.80	15.64	53.60	18.54	53.46	18.74	
48(118.4)	30.20	8.84	36.00	10.57	41.80	13.34	44.80	15.03	47.80	16.08	53.60	18.97	53.01	19.38	

**Cooling capacity table**

**MVD-V5X560W/V2GN1**

TC: Total Capacity (kW); PI: Power Input (kW) (Compressor + Outdoor fan motor)

Combination (%)	Outdoor temperature (°C(°F) DB)	Indoor temperature(°C(°F))													
		DB:20.8(69.4) WB:14(57.2)		DB:23.3(73.9) WB:16(60.8)		DB:25.8(78.4) WB:18(64.4)		DB:27(80.6) WB:19(66.2)		DB:28.2(82.8) WB:20(68)		DB:30.7(87.3) WB:22(71.6)		DB:32(89.6) WB:24(75.2)	
		TC	PI	TC	PI	TC	PI	TC	PI	TC	PI	TC	PI	TC	PI
		kW	kW	kW	kW	kW	kW	kW	kW	kW	kW	kW	kW	kW	kW
70%	-5(23)	26.40	3.64	31.60	4.27	36.60	4.84	39.20	5.19	41.80	5.54	46.80	6.33	52.00	7.28
	-2(28.4)	26.40	3.67	31.60	4.29	36.60	4.87	39.20	5.29	41.80	5.64	46.80	6.43	52.00	7.38
	0(32)	26.40	3.69	31.60	4.35	36.60	4.97	39.20	5.39	41.80	5.74	46.80	6.56	52.00	7.48
	2(35.6)	26.40	3.71	31.60	4.37	36.60	5.05	39.20	5.49	41.80	5.84	46.80	6.70	52.00	7.60
	4(39.2)	26.40	3.76	31.60	4.48	36.60	5.16	39.20	5.59	41.80	5.97	46.80	6.81	52.00	7.78
	6(42.8)	26.40	3.82	31.60	4.56	36.60	5.29	39.20	5.77	41.80	6.10	46.80	6.93	52.00	7.93
	8(46.4)	26.40	3.89	31.60	4.69	36.60	5.41	39.20	5.86	41.80	6.23	46.80	7.13	52.00	8.08
	10(50)	26.40	3.97	31.60	4.76	36.60	5.55	39.20	5.98	41.80	6.40	46.80	7.28	52.00	8.18
	12(53.6)	26.40	4.07	31.60	4.83	36.60	5.66	39.20	6.09	41.80	6.52	46.80	7.41	52.00	8.34
	14(57.2)	26.40	4.13	31.60	4.92	36.60	5.75	39.20	6.18	41.80	6.63	46.80	7.55	52.00	8.49
	16(60.8)	26.40	4.20	31.60	5.01	36.60	5.86	39.20	6.31	41.80	6.76	46.80	7.68	52.00	8.65
	18(64.4)	26.40	4.27	31.60	5.10	36.60	5.98	39.20	6.43	41.80	6.87	46.80	7.84	52.00	8.83
	20(68)	26.40	4.34	31.60	5.19	36.60	6.09	39.20	6.54	41.80	7.01	46.80	8.00	52.00	9.08
	21(69.8)	26.40	4.38	31.60	5.24	36.60	6.13	39.20	6.61	41.80	7.08	46.80	8.11	52.00	9.39
	23(73.4)	26.40	4.45	31.60	5.32	36.60	6.27	39.20	6.83	41.80	7.44	46.80	8.69	52.00	10.07
	25(77)	26.40	4.54	31.60	5.55	36.60	6.67	39.20	7.30	41.80	7.93	46.80	9.30	52.00	10.76
	27(80.6)	26.40	4.81	31.60	5.91	36.60	7.12	39.20	7.77	41.80	8.47	46.80	9.93	52.00	11.50
	29(84.2)	26.40	5.10	31.60	6.27	36.60	7.57	39.20	8.29	41.80	9.01	46.80	10.58	52.00	12.29
	31(87.8)	26.40	5.39	31.60	6.65	36.60	8.07	39.20	8.81	41.80	9.59	46.80	11.28	52.00	13.10
	33(91.4)	26.40	5.73	31.60	7.08	36.60	8.58	39.20	9.37	41.80	10.22	46.80	12.02	52.00	13.97
35(95)	26.40	6.07	31.60	7.50	36.60	9.10	39.20	9.98	41.80	10.87	46.80	12.81	52.00	14.90	
37(98.6)	26.40	6.40	31.60	7.95	36.60	9.68	39.20	10.58	41.80	11.57	46.80	13.64	52.00	15.86	
39(102.2)	26.40	6.79	31.60	8.43	36.60	10.27	39.20	11.26	41.80	12.29	46.80	14.49	52.00	16.90	
41(105.8)	26.40	7.08	31.60	8.72	36.60	10.57	39.20	11.63	41.80	12.66	46.80	15.09	52.00	17.64	
43(109.4)	26.40	7.66	31.60	9.32	36.60	11.00	39.20	12.25	41.80	13.04	46.80	15.64	52.00	18.19	
45(113)	26.40	7.83	31.60	9.52	36.60	11.23	39.20	12.45	41.80	13.69	46.80	16.49	52.00	18.89	
48(118.4)	26.40	8.34	31.60	10.12	36.60	11.93	39.20	13.05	41.80	14.09	46.80	16.98	52.00	19.29	
60%	-5(23)	22.60	3.11	27.00	3.60	31.40	4.20	33.60	4.47	35.80	4.83	40.20	5.42	44.60	6.22
	-2(28.4)	22.60	3.12	27.00	3.66	31.40	4.27	33.60	4.54	35.80	4.88	40.20	5.51	44.60	6.26
	0(32)	22.60	3.17	27.00	3.70	31.40	4.33	33.60	4.59	35.80	4.96	40.20	5.59	44.60	6.34
	2(35.6)	22.60	3.23	27.00	3.79	31.40	4.41	33.60	4.68	35.80	5.03	40.20	5.70	44.60	6.42
	4(39.2)	22.60	3.32	27.00	3.86	31.40	4.50	33.60	4.74	35.80	5.10	40.20	5.79	44.60	6.51
	6(42.8)	22.60	3.35	27.00	3.94	31.40	4.58	33.60	4.85	35.80	5.20	40.20	5.91	44.60	6.67
	8(46.4)	22.60	3.42	27.00	4.00	31.40	4.67	33.60	4.94	35.80	5.31	40.20	6.02	44.60	6.77
	10(50)	22.60	3.48	27.00	4.09	31.40	4.74	33.60	5.08	35.80	5.41	40.20	6.13	44.60	6.87
	12(53.6)	22.60	3.55	27.00	4.16	31.40	4.83	33.60	5.17	35.80	5.50	40.20	6.25	44.60	6.99
	14(57.2)	22.60	3.59	27.00	4.22	31.40	4.90	33.60	5.26	35.80	5.62	40.20	6.36	44.60	7.12
	16(60.8)	22.60	3.64	27.00	4.29	31.40	4.99	33.60	5.35	35.80	5.71	40.20	6.47	44.60	7.26
	18(64.4)	22.60	3.71	27.00	4.36	31.40	5.08	33.60	5.44	35.80	5.82	40.20	6.58	44.60	7.39
	20(68)	22.60	3.75	27.00	4.45	31.40	5.17	33.60	5.55	35.80	5.93	40.20	6.72	44.60	7.55
	21(69.8)	22.60	3.80	27.00	4.47	31.40	5.21	33.60	5.59	35.80	5.98	40.20	6.78	44.60	7.62
	23(73.4)	22.60	3.84	27.00	4.56	31.40	5.30	33.60	5.71	35.80	6.09	40.20	7.05	44.60	8.11
	25(77)	22.60	3.91	27.00	4.63	31.40	5.50	33.60	5.98	35.80	6.47	40.20	7.53	44.60	8.65
	27(80.6)	22.60	4.07	27.00	4.92	31.40	5.86	33.60	6.38	35.80	6.90	40.20	8.02	44.60	9.23
	29(84.2)	22.60	4.29	27.00	5.21	31.40	6.25	33.60	6.78	35.80	7.35	40.20	8.56	44.60	9.86
	31(87.8)	22.60	4.56	27.00	5.53	31.40	6.63	33.60	7.21	35.80	7.82	40.20	9.10	44.60	10.49
	33(91.4)	22.60	4.81	27.00	5.86	31.40	7.03	33.60	7.66	35.80	8.31	40.20	9.68	44.60	11.19
35(95)	22.60	5.10	27.00	6.22	31.40	7.46	33.60	8.13	35.80	8.83	40.20	10.31	44.60	11.91	
37(98.6)	22.60	5.39	27.00	6.58	31.40	7.91	33.60	8.63	35.80	9.37	40.20	10.96	44.60	12.67	
39(102.2)	22.60	5.68	27.00	6.96	31.40	8.38	33.60	9.14	35.80	9.95	40.20	11.64	44.60	13.48	
41(105.8)	22.60	5.87	27.00	7.26	31.40	8.68	33.60	9.51	35.80	10.32	40.20	12.18	44.60	14.09	
43(109.4)	22.60	6.05	27.00	7.57	31.40	8.99	33.60	9.79	35.80	10.68	40.20	12.70	44.60	14.70	
45(113)	22.60	6.33	27.00	7.95	31.40	9.35	33.60	10.16	35.80	11.21	40.20	13.27	44.60	15.51	
48(118.4)	22.60	6.82	27.00	8.49	31.40	9.84	33.60	10.77	35.80	12.08	40.20	13.98	44.60	16.73	

**Cooling capacity table**

**MVD-V5X560W/V2GN1**

TC: Total Capacity (kW); PI: Power Input (kW) (Compressor + Outdoor fan motor)

Combination (%)	Outdoor temperature (°C(°F) DB)	Indoor temperature(°C(°F))													
		DB:20.8(69.4) WB:14(57.2)		DB:23.3(73.9) WB:16(60.8)		DB:25.8(78.4) WB:18(64.4)		DB:27(80.6) WB:19(66.2)		DB:28.2(82.8) WB:20(68)		DB:30.7(87.3) WB:22(71.6)		DB:32(89.6) WB:24(75.2)	
		TC	PI	TC	PI	TC	PI	TC	PI	TC	PI	TC	PI	TC	PI
		kW	kW	kW	kW	kW	kW	kW	kW	kW	kW	kW	kW	kW	kW
50%	-5(23)	18.90	2.70	22.60	3.12	26.20	3.58	28.00	3.75	29.80	3.96	33.40	4.50	37.20	4.85
	-2(28.4)	18.90	2.72	22.60	3.18	26.20	3.62	28.00	3.80	29.80	4.03	33.40	4.56	37.20	4.92
	0(32)	18.90	2.76	22.60	3.23	26.20	3.69	28.00	3.86	29.80	4.08	33.40	4.64	37.20	5.00
	2(35.6)	18.90	2.80	22.60	3.27	26.20	3.75	28.00	3.91	29.80	4.15	33.40	4.66	37.20	5.10
	4(39.2)	18.90	2.83	22.60	3.33	26.20	3.79	28.00	3.96	29.80	4.23	33.40	4.77	37.20	5.23
	6(42.8)	18.90	2.88	22.60	3.38	26.20	3.85	28.00	4.05	29.80	4.31	33.40	4.85	37.20	5.38
	8(46.4)	18.90	2.95	22.60	3.44	26.20	3.91	28.00	4.14	29.80	4.37	33.40	4.93	37.20	5.56
	10(50)	18.90	3.01	22.60	3.48	26.20	3.98	28.00	4.21	29.80	4.49	33.40	5.05	37.20	5.64
	12(53.6)	18.90	3.03	22.60	3.53	26.20	4.04	28.00	4.29	29.80	4.58	33.40	5.14	37.20	5.73
	14(57.2)	18.90	3.08	22.60	3.57	26.20	4.09	28.00	4.38	29.80	4.65	33.40	5.23	37.20	5.84
	16(60.8)	18.90	3.12	22.60	3.62	26.20	4.16	28.00	4.45	29.80	4.72	33.40	5.32	37.20	5.93
	18(64.4)	18.90	3.17	22.60	3.68	26.20	4.22	28.00	4.52	29.80	4.81	33.40	5.41	37.20	6.04
	20(68)	18.90	3.21	22.60	3.73	26.20	4.29	28.00	4.58	29.80	4.90	33.40	5.50	37.20	6.16
	21(69.8)	18.90	3.23	22.60	3.77	26.20	4.34	28.00	4.63	29.80	4.94	33.40	5.57	37.20	6.22
	23(73.4)	18.90	3.28	22.60	3.82	26.20	4.40	28.00	4.72	29.80	5.03	33.40	5.66	37.20	6.36
	25(77)	18.90	3.32	22.60	3.89	26.20	4.49	28.00	4.81	29.80	5.19	33.40	5.95	37.20	6.78
	27(80.6)	18.90	3.39	22.60	4.04	26.20	4.74	28.00	5.12	29.80	5.50	33.40	6.34	37.20	7.23
	29(84.2)	18.90	3.57	22.60	4.27	26.20	5.03	28.00	5.44	29.80	5.86	33.40	6.74	37.20	7.71
	31(87.8)	18.90	3.77	22.60	4.52	26.20	5.32	28.00	5.77	29.80	6.22	33.40	7.17	37.20	8.20
	33(91.4)	18.90	4.00	22.60	4.78	26.20	5.66	28.00	6.11	29.80	6.60	33.40	7.62	37.20	8.72
35(95)	18.90	4.22	22.60	5.05	26.20	5.98	28.00	6.47	29.80	6.99	33.40	8.09	37.20	9.26	
37(98.6)	18.90	4.45	22.60	5.35	26.20	6.34	28.00	6.85	29.80	7.41	33.40	8.58	37.20	9.84	
39(102.2)	18.90	4.70	22.60	5.64	26.20	6.69	28.00	7.26	29.80	7.86	33.40	9.10	37.20	10.45	
41(105.8)	18.90	4.89	22.60	5.88	26.20	6.94	28.00	7.60	29.80	8.20	33.40	9.58	37.20	10.93	
43(109.4)	18.90	5.21	22.60	6.29	26.20	7.18	28.00	7.93	29.80	8.41	33.40	10.07	37.20	11.42	
45(113)	18.90	5.33	22.60	6.45	26.20	7.66	28.00	8.55	29.80	8.77	33.40	11.04	37.20	12.39	
48(118.4)	18.90	5.69	22.60	6.93	26.20	7.99	28.00	8.94	29.80	9.03	33.40	11.69	37.20	13.03	



**Cooling capacity table**

**MVD-V5X615W/V2GN1**

TC: Total Capacity (kW); PI: Power Input (kW) (Compressor + Outdoor fan motor)

Combination (%)	Outdoor temperature (°C(°F) DB)	Indoor temperature(°C(°F))													
		DB:20.8(69.4) WB:14(57.2)		DB:23.3(73.9) WB:16(60.8)		DB:25.8(78.4) WB:18(64.4)		DB:27(80.6) WB:19(66.2)		DB:28.2(82.8) WB:20(68)		DB:30.7(87.3) WB:22(71.6)		DB:32(89.6) WB:24(75.2)	
		TC	PI	TC	PI	TC	PI	TC	PI	TC	PI	TC	PI	TC	PI
		kW	kW	kW	kW	kW	kW	kW	kW	kW	kW	kW	kW	kW	kW
130%	-5(23)	54.03	7.67	64.35	9.36	74.67	10.04	77.53	10.45	81.26	10.74	83.24	11.68	85.33	11.76
	-2(28.4)	54.03	7.67	64.35	9.55	74.67	10.04	77.53	10.51	81.26	10.74	83.24	11.83	85.33	11.87
	0(32)	54.03	7.80	64.35	9.71	74.67	10.41	77.53	11.08	81.26	11.37	83.24	11.98	85.33	12.03
	2(35.6)	54.03	7.94	64.35	9.73	74.67	10.76	77.53	11.71	81.26	11.50	83.24	12.06	85.33	12.21
	4(39.2)	54.03	8.12	64.35	9.92	74.67	11.13	77.53	11.76	81.26	11.65	83.24	12.06	85.33	12.44
	6(42.8)	54.03	8.28	64.35	10.12	74.67	11.55	77.53	11.86	80.35	12.01	82.22	12.05	84.40	12.53
	8(46.4)	54.03	8.48	64.35	10.35	74.67	12.12	77.53	12.44	79.36	12.40	81.33	3.90	83.32	12.66
	10(50)	54.03	8.65	64.35	10.58	74.67	12.57	77.53	12.85	78.41	4.04	80.39	4.06	82.36	13.02
	12(53.6)	54.03	8.80	64.35	10.78	74.67	12.83	76.43	4.03	77.53	4.06	79.29	4.07	81.26	13.11
	14(57.2)	54.03	8.98	64.35	10.98	74.46	4.05	75.56	4.06	76.43	4.08	78.41	4.09	80.39	13.40
	16(60.8)	54.03	9.13	64.35	11.21	73.58	4.06	74.46	4.08	75.34	4.10	77.31	4.12	79.29	13.61
	18(64.4)	54.03	9.31	64.35	11.44	72.48	13.41	73.36	13.48	74.46	13.56	76.43	13.69	78.41	13.81
	20(68)	54.03	9.51	64.35	12.17	71.38	14.07	72.48	14.14	73.36	14.22	75.34	14.34	77.31	14.50
	21(69.8)	54.03	9.77	64.35	12.60	70.94	14.40	72.04	14.47	72.92	14.55	74.89	14.70	76.87	14.82
	23(73.4)	54.03	10.47	64.35	13.51	70.06	15.05	70.94	15.13	71.82	15.20	73.79	15.36	75.77	15.51
	25(77)	54.03	11.18	64.35	14.47	68.96	15.71	69.84	15.79	70.94	15.89	72.92	16.04	74.89	16.19
	27(80.6)	54.03	11.94	64.35	15.48	68.09	16.37	68.96	16.47	69.84	16.54	71.82	16.72	73.79	16.90
	29(84.2)	54.03	12.75	64.35	16.54	66.99	17.03	67.87	17.13	68.96	17.23	70.94	17.41	72.92	17.58
	31(87.8)	54.03	13.61	64.14	17.51	65.89	17.71	66.99	17.81	67.87	17.89	69.84	18.09	71.82	18.29
	33(91.4)	54.03	14.50	63.03	18.16	65.01	18.37	65.89	18.47	66.99	18.57	68.96	18.77	70.72	18.97
35(95)	54.03	15.46	61.94	18.82	63.91	19.05	65.01	19.15	65.89	19.25	67.87	19.48	69.84	19.68	
37(98.6)	54.03	16.44	61.06	19.51	63.04	19.73	63.91	19.83	65.01	19.96	66.77	20.19	68.74	20.42	
39(102.2)	54.03	17.51	59.96	19.71	61.94	20.39	63.04	20.52	63.91	20.64	65.89	20.87	67.87	21.12	
41(105.8)	54.03	18.43	59.34	19.90	61.29	20.58	62.39	20.71	63.26	20.83	65.24	20.91	65.27	21.32	
43(109.4)	54.03	18.89	58.91	20.00	60.96	20.64	62.06	20.80	62.61	20.86	64.05	20.95	64.49	21.36	
45(113)	54.03	19.83	58.54	20.19	60.31	20.83	61.41	20.94	61.70	20.96	62.31	21.03	63.22	21.77	
48(118.4)	54.03	21.24	58.35	20.47	59.34	21.23	60.43	21.05	60.92	21.16	60.66	21.14	61.76	22.83	
120%	-5(23)	49.86	7.41	59.30	8.98	68.97	10.62	73.80	11.58	77.31	12.07	79.07	12.45	80.83	12.78
	-2(28.4)	49.86	7.48	59.30	9.07	68.97	10.72	73.80	11.64	77.31	12.21	79.07	12.56	80.83	12.83
	0(32)	49.86	7.55	59.30	9.13	68.97	10.84	73.80	11.67	77.31	12.32	79.07	12.63	80.83	12.85
	2(35.6)	49.86	7.57	59.30	9.23	68.97	10.92	73.80	11.78	77.31	12.37	79.07	12.72	80.83	12.88
	4(39.2)	49.86	7.65	59.30	9.34	68.97	11.07	73.80	11.89	77.31	12.53	79.07	12.75	80.83	12.91
	6(42.8)	49.86	7.73	59.30	9.42	68.97	11.20	73.80	12.02	77.31	12.67	79.07	12.86	80.83	12.95
	8(46.4)	49.86	7.80	59.30	9.51	68.97	11.36	73.80	12.17	77.31	12.79	79.07	12.90	80.83	13.02
	10(50)	49.86	7.89	59.30	9.64	68.97	11.46	73.80	12.40	77.31	12.80	79.07	12.94	80.83	13.07
	12(53.6)	49.86	8.04	59.30	9.82	68.97	11.69	73.80	12.62	76.22	12.86	77.97	12.86	79.73	13.16
	14(57.2)	49.86	8.20	59.30	10.02	68.97	11.91	73.80	12.88	75.12	12.94	77.09	13.06	78.85	13.32
	16(60.8)	49.86	8.35	59.30	10.22	68.97	12.14	73.36	4.10	74.24	13.13	76.00	13.28	77.75	13.52
	18(64.4)	49.86	8.50	59.30	10.42	68.97	12.55	72.26	13.41	73.14	13.46	74.90	13.58	76.87	13.71
	20(68)	49.86	8.68	59.30	10.83	68.97	13.51	71.38	14.07	72.26	14.12	74.02	14.24	75.78	14.37
	21(69.8)	49.86	8.75	59.30	11.21	68.97	13.99	70.72	14.39	71.60	14.44	73.58	14.57	75.34	14.72
	23(73.4)	49.86	9.36	59.30	12.02	68.97	14.98	69.85	15.03	70.72	15.10	72.48	15.25	74.24	15.38
	25(77)	49.86	9.99	59.30	12.85	67.87	15.63	68.75	15.68	69.63	15.76	71.60	15.91	73.36	16.06
	27(80.6)	49.86	10.68	59.30	13.74	66.99	16.27	67.87	16.37	68.75	16.44	70.50	16.59	72.26	16.75
	29(84.2)	49.86	11.38	59.30	14.67	65.89	16.92	66.77	17.02	67.65	17.10	69.41	17.28	71.38	17.43
	31(87.8)	49.86	12.14	59.30	15.66	64.79	17.61	65.89	17.68	66.77	17.78	68.53	17.96	70.28	18.14
	33(91.4)	49.86	12.93	59.30	16.70	63.91	18.26	64.79	18.37	65.67	18.44	67.43	18.64	69.19	18.82
35(95)	49.86	13.76	59.30	17.81	62.82	18.92	63.70	19.02	64.79	19.12	66.55	19.33	68.31	19.53	
37(98.6)	49.86	14.65	59.30	18.97	61.94	19.61	62.82	19.71	63.70	19.81	65.45	20.01	67.21	20.24	
39(102.2)	49.86	15.58	59.08	20.04	60.84	20.26	61.72	20.39	62.60	20.49	64.57	20.72	66.33	20.92	
41(105.8)	49.86	16.01	58.61	20.18	60.36	20.41	61.24	20.53	62.12	20.63	64.10	20.78	64.42	21.08	
43(109.4)	49.86	16.25	58.29	20.32	59.89	20.53	60.77	20.61	61.64	20.71	62.98	20.83	63.42	21.50	
45(113)	49.86	16.44	57.97	20.51	59.31	20.72	60.13	20.80	61.10	20.87	61.71	20.90	62.79	21.97	
48(118.4)	49.86	16.72	57.48	20.80	58.55	20.98	59.17	21.06	60.43	21.26	60.75	21.29	61.96	22.25	

**Cooling capacity table**

**MVD-V5X615W/V2GN1**

TC: Total Capacity (kW); PI: Power Input (kW) (Compressor + Outdoor fan motor)

Combination (%)	Outdoor temperature (°C(°F) DB)	Indoor temperature(°C(°F))													
		DB:20.8(69.4) WB:14(57.2)		DB:23.3(73.9) WB:16(60.8)		DB:25.8(78.4) WB:18(64.4)		DB:27(80.6) WB:19(66.2)		DB:28.2(82.8) WB:20(68)		DB:30.7(87.3) WB:22(71.6)		DB:32(89.6) WB:24(75.2)	
		TC	PI	TC	PI	TC	PI	TC	PI	TC	PI	TC	PI	TC	PI
		kW	kW	kW	kW	kW	kW	kW	kW	kW	kW	kW	kW	kW	kW
110%	-5(23)	45.69	6.47	54.48	8.06	63.26	9.61	67.65	10.32	72.04	11.10	77.54	11.53	79.30	11.89
	-2(28.4)	45.69	6.60	54.48	8.16	63.26	9.69	67.65	10.42	72.04	11.19	77.54	11.64	79.30	11.95
	0(32)	45.69	6.66	54.48	8.21	63.26	9.77	67.65	10.49	72.04	11.31	77.54	11.76	79.30	12.09
	2(35.6)	45.69	6.81	54.48	8.28	63.26	9.92	67.65	10.60	72.04	11.43	77.54	11.93	79.30	12.25
	4(39.2)	45.69	6.94	54.48	8.38	63.26	10.02	67.65	10.73	72.04	11.61	77.54	12.09	79.30	12.36
	6(42.8)	45.69	7.01	54.48	8.48	63.26	10.11	67.65	10.90	72.04	11.74	77.54	12.22	79.30	12.55
	8(46.4)	45.69	7.08	54.48	8.61	63.26	10.23	67.65	11.02	72.04	11.87	77.54	12.30	79.30	12.68
	10(50)	45.69	7.16	54.48	8.73	63.26	10.37	67.65	11.21	72.04	12.07	77.54	12.39	79.30	12.79
	12(53.6)	45.69	7.31	54.48	8.90	63.26	10.58	67.65	11.43	72.04	12.29	76.66	12.57	78.19	12.96
	14(57.2)	45.69	7.44	54.48	9.06	63.26	10.78	67.65	11.64	72.04	12.52	75.56	12.67	77.32	13.05
	16(60.8)	45.69	7.56	54.48	9.23	63.26	10.98	67.65	11.86	72.04	12.77	74.68	12.83	76.22	13.19
	18(64.4)	45.69	7.72	54.48	9.41	63.26	11.21	67.65	12.19	72.04	13.38	73.58	13.48	75.34	13.61
	20(68)	45.69	7.87	54.48	9.61	63.26	11.86	67.65	13.10	70.95	14.04	72.70	14.14	74.24	14.27
	21(69.8)	45.69	7.94	54.48	9.89	63.26	12.29	67.65	13.59	70.51	14.37	72.05	14.47	73.80	14.60
	23(73.4)	45.69	8.32	54.48	10.60	63.26	13.18	67.65	14.57	69.41	15.00	71.17	15.15	72.70	15.28
	25(77)	45.69	8.88	54.48	11.33	63.26	14.09	67.65	15.61	68.53	15.66	70.07	15.81	71.82	15.94
	27(80.6)	45.69	9.46	54.48	12.12	63.26	15.08	66.56	16.27	67.43	16.32	69.19	16.47	70.73	16.62
	29(84.2)	45.69	10.09	54.48	12.93	63.26	16.11	65.67	16.92	66.56	17.00	68.09	17.15	69.85	17.30
	31(87.8)	45.69	10.75	54.48	13.79	63.26	17.20	64.58	17.58	65.46	17.66	67.21	17.81	68.75	17.99
	33(91.4)	45.69	11.43	54.48	14.70	62.82	18.14	63.70	18.24	64.58	18.32	66.11	18.49	67.87	18.67
35(95)	45.69	12.17	54.48	15.66	61.72	18.80	62.60	18.90	63.48	19.00	65.02	19.18	66.78	19.35	
37(98.6)	45.69	12.95	54.48	16.67	60.84	19.48	61.72	19.56	62.38	19.66	64.14	19.86	65.67	20.04	
39(102.2)	45.69	13.76	54.48	17.76	59.75	20.14	60.62	20.24	61.51	20.34	63.04	20.54	64.80	20.74	
41(105.8)	45.69	13.90	54.48	17.90	59.28	20.28	60.15	20.38	61.04	20.48	62.24	20.68	62.85	20.89	
43(109.4)	45.69	14.04	54.48	18.13	58.81	20.42	59.68	20.52	60.57	20.62	61.68	20.76	61.88	21.31	
45(113)	45.69	14.50	54.48	18.23	58.21	20.61	59.06	20.77	60.03	20.81	61.06	21.33	61.31	21.81	
48(118.4)	45.69	14.86	54.48	18.52	57.37	20.89	58.12	21.10	59.35	21.23	60.05	22.15	60.52	22.94	
100%	-5(23)	41.51	5.89	49.42	7.10	57.55	8.45	61.50	9.05	65.45	9.82	73.58	11.19	77.75	11.67
	-2(28.4)	41.51	5.97	49.42	7.19	57.55	8.54	61.50	9.22	65.45	9.95	73.58	11.32	77.75	11.75
	0(32)	41.51	6.03	49.42	7.26	57.55	8.63	61.50	9.33	65.45	10.04	73.58	11.51	77.75	11.88
	2(35.6)	41.51	6.15	49.42	7.36	57.55	8.73	61.50	9.45	65.45	10.15	73.58	11.67	77.75	12.07
	4(39.2)	41.51	6.19	49.42	7.43	57.55	8.86	61.50	9.59	65.45	10.29	73.58	11.79	77.75	12.20
	6(42.8)	41.51	6.28	49.42	7.58	57.55	8.97	61.50	9.76	65.45	10.44	73.58	11.96	77.75	12.39
	8(46.4)	41.51	6.40	49.42	7.70	57.55	9.14	61.50	9.87	65.45	10.61	73.58	12.14	77.75	12.59
	10(50)	41.51	6.48	49.42	7.84	57.55	9.28	61.50	10.04	65.45	10.80	73.58	12.35	77.75	12.77
	12(53.6)	41.51	6.58	49.42	7.99	57.55	9.46	61.50	10.22	65.45	11.00	73.58	12.57	76.65	12.87
	14(57.2)	41.51	6.70	49.42	8.15	57.55	9.64	61.50	10.42	65.45	11.21	73.58	12.82	75.77	13.03
	16(60.8)	41.51	6.83	49.42	8.30	57.55	9.84	61.50	10.62	65.45	11.43	73.14	12.98	74.68	13.18
	18(64.4)	41.51	6.96	49.42	8.45	57.55	10.02	61.50	10.83	65.45	11.66	72.26	13.41	73.80	13.51
	20(68)	41.51	7.08	49.42	8.63	57.55	10.32	61.50	11.38	65.45	12.50	71.16	14.04	72.70	14.17
	21(69.8)	41.51	7.16	49.42	8.70	57.55	10.70	61.50	11.79	65.45	12.93	70.73	14.37	72.26	14.49
	23(73.4)	41.51	7.34	49.42	9.28	57.55	11.46	61.50	12.62	65.45	13.86	69.85	15.03	71.16	15.15
	25(77)	41.51	7.82	49.42	9.92	57.55	12.27	61.50	13.53	65.45	14.85	68.75	15.68	70.28	15.81
	27(80.6)	41.51	8.35	49.42	10.57	57.55	13.10	61.50	14.47	65.45	15.89	67.65	16.34	69.19	16.49
	29(84.2)	41.51	8.88	49.42	11.28	57.55	13.99	61.50	15.46	65.23	16.87	66.77	17.02	68.31	17.15
	31(87.8)	41.51	9.46	49.42	12.04	57.55	14.92	61.50	16.49	64.35	17.53	65.68	17.68	67.21	17.83
	33(91.4)	41.51	10.04	49.42	12.83	57.55	15.91	61.50	17.61	63.26	18.19	64.80	18.34	66.33	18.52
35(95)	41.51	10.67	49.42	13.63	57.55	16.97	61.50	18.77	62.16	18.85	63.70	19.02	65.23	19.18	
37(98.6)	41.51	11.36	49.42	14.52	57.55	18.09	60.39	19.43	61.28	19.53	62.82	19.70	64.14	19.86	
39(102.2)	41.51	12.07	49.42	15.43	57.55	19.25	59.52	20.09	60.18	20.19	61.72	20.36	63.26	20.57	
41(105.8)	41.51	12.63	49.42	15.99	57.55	19.95	58.60	20.23	59.72	20.50	61.01	20.84	62.34	20.99	
43(109.4)	41.51	13.19	49.42	16.56	57.55	20.32	57.67	20.46	59.29	20.69	60.64	20.98	61.24	21.22	
45(113)	41.51	13.94	49.42	17.31	57.55	20.67	57.62	20.74	58.98	21.07	60.01	21.30	60.50	21.50	
48(118.4)	41.51	15.07	49.42	18.43	57.55	21.02	57.58	21.31	58.89	21.87	59.52	21.91	60.13	22.07	

**Cooling capacity table**

**MVD-V5X615W/V2GN1**

TC: Total Capacity (kW); PI: Power Input (kW) (Compressor + Outdoor fan motor)

Combination (%)	Outdoor temperature (°C(°F) DB)	Indoor temperature(°C(°F))													
		DB:20.8(69.4) WB:14(57.2)		DB:23.3(73.9) WB:16(60.8)		DB:25.8(78.4) WB:18(64.4)		DB:27(80.6) WB:19(66.2)		DB:28.2(82.8) WB:20(68)		DB:30.7(87.3) WB:22(71.6)		DB:32(89.6) WB:24(75.2)	
		TC	PI	TC	PI	TC	PI	TC	PI	TC	PI	TC	PI	TC	PI
		kW	kW	kW	kW	kW	kW	kW	kW	kW	kW	kW	kW	kW	kW
90%	-5(23)	37.34	5.21	44.59	6.25	51.84	7.38	55.35	8.05	58.86	8.56	66.11	9.85	73.36	11.28
	-2(28.4)	37.34	5.26	44.59	6.32	51.84	7.47	55.35	8.16	58.86	8.67	66.11	9.94	73.36	11.39
	0(32)	37.34	5.34	44.59	6.40	51.84	7.59	55.35	8.26	58.86	8.78	66.11	10.06	73.36	11.47
	2(35.6)	37.34	5.42	44.59	6.48	51.84	7.67	55.35	8.39	58.86	8.92	66.11	10.26	73.36	11.64
	4(39.2)	37.34	5.50	44.59	6.58	51.84	7.79	55.35	8.50	58.86	9.03	66.11	10.42	73.36	11.81
	6(42.8)	37.34	5.58	44.59	6.70	51.84	7.94	55.35	8.66	58.86	9.19	66.11	10.59	73.36	12.01
	8(46.4)	37.34	5.69	44.59	6.83	51.84	8.10	55.35	8.77	58.86	9.35	66.11	10.78	73.36	12.12
	10(50)	37.34	5.79	44.59	6.98	51.84	8.25	55.35	8.90	58.86	9.56	66.11	10.92	73.36	12.32
	12(53.6)	37.34	5.89	44.59	7.11	51.84	8.40	55.35	9.05	58.86	9.74	66.11	11.13	73.36	12.55
	14(57.2)	37.34	5.99	44.59	7.23	51.84	8.55	55.35	9.23	58.86	9.92	66.11	11.33	73.36	12.77
	16(60.8)	37.34	6.10	44.59	7.36	51.84	8.73	55.35	9.41	58.86	10.12	66.11	11.56	73.14	13.00
	18(64.4)	37.34	6.20	44.59	7.51	51.84	8.88	55.35	9.59	58.86	10.32	66.11	11.79	72.26	13.41
	20(68)	37.34	6.32	44.59	7.68	51.84	9.06	55.35	9.79	58.86	10.70	66.11	12.67	71.16	14.04
	21(69.8)	37.34	6.37	44.59	7.74	51.84	9.21	55.35	10.12	58.86	11.08	66.11	13.13	70.73	14.37
	23(73.4)	37.34	6.50	44.59	8.04	51.84	9.86	55.35	10.85	58.86	11.89	66.11	14.09	69.62	15.03
	25(77)	37.34	6.85	44.59	8.60	51.84	10.55	55.35	11.61	58.86	12.70	66.11	15.08	68.75	15.68
	27(80.6)	37.34	7.29	44.59	9.16	51.84	11.26	55.35	12.40	58.86	13.58	66.11	16.14	67.65	16.34
	29(84.2)	37.34	7.77	44.59	9.76	51.84	12.01	55.35	13.23	58.86	14.52	65.45	16.87	66.77	17.00
	31(87.8)	37.34	8.25	44.59	10.40	51.84	12.80	55.35	14.11	58.86	15.48	64.36	17.53	65.67	17.68
	33(91.4)	37.34	8.75	44.59	11.05	51.84	13.66	55.35	15.05	58.86	16.52	63.48	18.21	64.79	18.34
35(95)	37.34	9.31	44.59	11.76	51.84	14.54	55.35	16.04	58.86	17.61	62.38	18.87	63.70	19.02	
37(98.6)	37.34	9.86	44.59	12.50	51.84	15.48	55.35	17.07	58.86	18.77	61.28	19.53	62.82	19.68	
39(102.2)	37.34	10.47	44.59	13.31	51.84	16.47	55.35	18.19	58.86	19.98	60.40	20.21	61.72	20.36	
41(105.8)	37.34	10.83	44.59	13.91	51.84	17.07	55.35	18.67	58.86	20.10	59.98	20.73	61.31	20.84	
43(109.4)	37.34	11.35	44.59	14.51	51.84	17.67	55.35	19.15	58.86	20.53	59.67	20.99	60.78	21.17	
45(113)	37.34	12.08	44.59	15.23	51.84	18.39	55.35	19.79	58.86	21.10	59.34	21.21	59.85	21.45	
48(118.4)	37.34	13.04	44.59	16.19	51.84	19.35	55.35	20.75	58.86	21.57	59.11	21.64	59.39	21.81	
80%	-5(23)	33.17	4.59	39.54	5.43	45.90	6.43	49.20	6.84	52.50	7.36	58.86	8.51	65.23	9.71
	-2(28.4)	33.17	4.66	39.54	5.50	45.90	6.48	49.20	6.94	52.50	7.43	58.86	8.59	65.23	9.81
	0(32)	33.17	4.74	39.54	5.57	45.90	6.57	49.20	7.02	52.50	7.56	58.86	8.71	65.23	9.94
	2(35.6)	33.17	4.84	39.54	5.65	45.90	6.66	49.20	7.16	52.50	7.70	58.86	8.89	65.23	10.13
	4(39.2)	33.17	4.92	39.54	5.74	45.90	6.79	49.20	7.32	52.50	7.84	58.86	9.05	65.23	10.27
	6(42.8)	33.17	5.00	39.54	5.88	45.90	6.89	49.20	7.48	52.50	7.98	58.86	9.19	65.23	10.44
	8(46.4)	33.17	5.09	39.54	6.01	45.90	7.05	49.20	7.61	52.50	8.16	58.86	9.32	65.23	10.64
	10(50)	33.17	5.13	39.54	6.15	45.90	7.24	49.20	7.79	52.50	8.35	58.86	9.54	65.23	10.75
	12(53.6)	33.17	5.21	39.54	6.25	45.90	7.36	49.20	7.94	52.50	8.53	58.86	9.71	65.23	10.95
	14(57.2)	33.17	5.31	39.54	6.37	45.90	7.49	49.20	8.07	52.50	8.68	58.86	9.89	65.23	11.16
	16(60.8)	33.17	5.39	39.54	6.48	45.90	7.64	49.20	8.22	52.50	8.83	58.86	10.09	65.23	11.36
	18(64.4)	33.17	5.49	39.54	6.60	45.90	7.79	49.20	8.40	52.50	9.01	58.86	10.30	65.23	11.59
	20(68)	33.17	5.59	39.54	6.73	45.90	7.94	49.20	8.55	52.50	9.18	58.86	10.68	65.23	12.40
	21(69.8)	33.17	5.64	39.54	6.78	45.90	8.02	49.20	8.65	52.50	9.39	58.86	11.06	65.23	12.85
	23(73.4)	33.17	5.74	39.54	6.93	45.90	8.40	49.20	9.21	52.50	10.04	58.86	11.84	65.23	13.79
	25(77)	33.17	5.92	39.54	7.36	45.90	8.98	49.20	9.84	52.50	10.73	58.86	12.67	65.23	14.75
	27(80.6)	33.17	6.30	39.54	7.84	45.90	9.56	49.20	10.50	52.50	11.46	58.86	13.53	65.23	15.78
	29(84.2)	33.17	6.70	39.54	8.35	45.90	10.20	49.20	11.18	52.50	12.24	58.86	14.44	65.23	16.87
	31(87.8)	33.17	7.11	39.54	8.88	45.90	10.85	49.20	11.91	52.50	13.05	58.86	15.43	64.14	17.53
	33(91.4)	33.17	7.56	39.54	9.44	45.90	11.56	49.20	12.70	52.50	13.89	58.86	16.44	63.26	18.19
35(95)	33.17	8.02	39.54	10.04	45.90	12.29	49.20	13.51	52.50	14.80	58.86	17.53	62.16	18.85	
37(98.6)	33.17	8.50	39.54	10.65	45.90	13.08	49.20	14.39	52.50	15.76	58.86	18.69	61.28	19.50	
39(102.2)	33.17	9.01	39.54	11.36	45.90	13.91	49.20	15.31	52.50	16.77	58.86	19.91	60.18	20.19	
41(105.8)	33.17	9.21	39.54	11.46	45.90	14.12	49.20	15.71	52.50	17.08	58.86	20.42	59.81	20.54	
43(109.4)	33.17	9.48	39.54	11.56	45.90	14.32	49.20	15.98	52.50	17.31	58.86	20.65	59.44	20.76	
45(113)	33.17	9.75	39.54	11.70	45.90	14.60	49.20	16.32	52.50	17.61	58.86	20.88	58.71	21.10	
48(118.4)	33.17	9.95	39.54	11.90	45.90	15.02	49.20	16.93	52.50	18.11	58.86	21.36	58.21	21.82	

**Cooling capacity table**

**MVD-V5X615W/V2GN1**

TC: Total Capacity (kW); PI: Power Input (kW) (Compressor + Outdoor fan motor)

Combination (%)	Outdoor temperature (°C(°F) DB)	Indoor temperature(°C(°F))													
		DB:20.8(69.4) WB:14(57.2)		DB:23.3(73.9) WB:16(60.8)		DB:25.8(78.4) WB:18(64.4)		DB:27(80.6) WB:19(66.2)		DB:28.2(82.8) WB:20(68)		DB:30.7(87.3) WB:22(71.6)		DB:32(89.6) WB:24(75.2)	
		TC	PI	TC	PI	TC	PI	TC	PI	TC	PI	TC	PI	TC	PI
		kW	kW	kW	kW	kW	kW	kW	kW	kW	kW	kW	kW	kW	kW
70%	-5(23)	28.99	4.10	34.70	4.81	40.20	5.45	43.05	5.84	45.90	6.23	51.40	7.13	57.11	8.20
	-2(28.4)	28.99	4.13	34.70	4.83	40.20	5.48	43.05	5.95	45.90	6.35	51.40	7.24	57.11	8.31
	0(32)	28.99	4.16	34.70	4.90	40.20	5.59	43.05	6.07	45.90	6.46	51.40	7.39	57.11	8.42
	2(35.6)	28.99	4.18	34.70	4.92	40.20	5.68	43.05	6.18	45.90	6.57	51.40	7.55	57.11	8.56
	4(39.2)	28.99	4.23	34.70	5.04	40.20	5.81	43.05	6.29	45.90	6.72	51.40	7.67	57.11	8.76
	6(42.8)	28.99	4.30	34.70	5.13	40.20	5.95	43.05	6.49	45.90	6.87	51.40	7.81	57.11	8.93
	8(46.4)	28.99	4.38	34.70	5.28	40.20	6.09	43.05	6.59	45.90	7.02	51.40	8.03	57.11	9.10
	10(50)	28.99	4.47	34.70	5.36	40.20	6.25	43.05	6.73	45.90	7.21	51.40	8.20	57.11	9.21
	12(53.6)	28.99	4.58	34.70	5.44	40.20	6.38	43.05	6.86	45.90	7.34	51.40	8.35	57.11	9.39
	14(57.2)	28.99	4.65	34.70	5.54	40.20	6.48	43.05	6.96	45.90	7.46	51.40	8.50	57.11	9.56
	16(60.8)	28.99	4.73	34.70	5.64	40.20	6.60	43.05	7.11	45.90	7.61	51.40	8.65	57.11	9.74
	18(64.4)	28.99	4.81	34.70	5.74	40.20	6.73	43.05	7.23	45.90	7.74	51.40	8.83	57.11	9.94
	20(68)	28.99	4.88	34.70	5.84	40.20	6.86	43.05	7.36	45.90	7.89	51.40	9.01	57.11	10.22
	21(69.8)	28.99	4.93	34.70	5.89	40.20	6.91	43.05	7.44	45.90	7.97	51.40	9.13	57.11	10.57
	23(73.4)	28.99	5.01	34.70	6.00	40.20	7.06	43.05	7.69	45.90	8.37	51.40	9.79	57.11	11.33
	25(77)	28.99	5.11	34.70	6.25	40.20	7.51	43.05	8.22	45.90	8.93	51.40	10.47	57.11	12.12
	27(80.6)	28.99	5.41	34.70	6.65	40.20	8.02	43.05	8.75	45.90	9.54	51.40	11.18	57.11	12.95
	29(84.2)	28.99	5.74	34.70	7.06	40.20	8.53	43.05	9.33	45.90	10.14	51.40	11.91	57.11	13.84
	31(87.8)	28.99	6.07	34.70	7.49	40.20	9.08	43.05	9.92	45.90	10.80	51.40	12.70	57.11	14.75
	33(91.4)	28.99	6.45	34.70	7.97	40.20	9.66	43.05	10.55	45.90	11.51	51.40	13.53	57.11	15.73
35(95)	28.99	6.83	34.70	8.45	40.20	10.25	43.05	11.23	45.90	12.24	51.40	14.42	57.11	16.77	
37(98.6)	28.99	7.21	34.70	8.96	40.20	10.90	43.05	11.91	45.90	13.03	51.40	15.36	57.11	17.86	
39(102.2)	28.99	7.64	34.70	9.49	40.20	11.56	43.05	12.67	45.90	13.84	51.40	16.32	57.11	19.02	
41(105.8)	28.99	7.98	34.70	9.82	40.20	11.90	43.05	13.10	45.90	14.26	51.40	16.99	57.11	19.87	
43(109.4)	28.99	8.63	34.70	10.50	40.20	12.39	43.05	13.80	45.90	14.68	51.40	17.61	57.11	20.48	
45(113)	28.99	8.82	34.70	10.72	40.20	12.65	43.05	14.02	45.90	15.41	51.40	18.56	57.11	21.27	
48(118.4)	28.99	9.39	34.70	11.40	40.20	13.43	43.05	14.70	45.90	15.86	51.40	19.12	57.11	21.72	
60%	-5(23)	24.82	3.50	29.65	4.06	34.48	4.73	36.90	5.04	39.32	5.44	44.15	6.11	48.98	7.00
	-2(28.4)	24.82	3.52	29.65	4.12	34.48	4.81	36.90	5.11	39.32	5.49	44.15	6.20	48.98	7.05
	0(32)	24.82	3.57	29.65	4.17	34.48	4.88	36.90	5.17	39.32	5.59	44.15	6.29	48.98	7.14
	2(35.6)	24.82	3.63	29.65	4.27	34.48	4.97	36.90	5.27	39.32	5.66	44.15	6.42	48.98	7.23
	4(39.2)	24.82	3.74	29.65	4.35	34.48	5.06	36.90	5.34	39.32	5.74	44.15	6.52	48.98	7.33
	6(42.8)	24.82	3.77	29.65	4.43	34.48	5.16	36.90	5.46	39.32	5.86	44.15	6.65	48.98	7.51
	8(46.4)	24.82	3.85	29.65	4.50	34.48	5.26	36.90	5.56	39.32	5.98	44.15	6.78	48.98	7.63
	10(50)	24.82	3.92	29.65	4.60	34.48	5.34	36.90	5.72	39.32	6.10	44.15	6.90	48.98	7.74
	12(53.6)	24.82	4.00	29.65	4.68	34.48	5.44	36.90	5.82	39.32	6.20	44.15	7.03	48.98	7.87
	14(57.2)	24.82	4.05	29.65	4.75	34.48	5.51	36.90	5.92	39.32	6.32	44.15	7.16	48.98	8.02
	16(60.8)	24.82	4.10	29.65	4.83	34.48	5.62	36.90	6.02	39.32	6.42	44.15	7.28	48.98	8.17
	18(64.4)	24.82	4.17	29.65	4.91	34.48	5.72	36.90	6.12	39.32	6.55	44.15	7.41	48.98	8.32
	20(68)	24.82	4.22	29.65	5.01	34.48	5.82	36.90	6.25	39.32	6.68	44.15	7.56	48.98	8.50
	21(69.8)	24.82	4.27	29.65	5.03	34.48	5.87	36.90	6.30	39.32	6.73	44.15	7.64	48.98	8.57
	23(73.4)	24.82	4.33	29.65	5.13	34.48	5.97	36.90	6.42	39.32	6.85	44.15	7.94	48.98	9.13
	25(77)	24.82	4.40	29.65	5.21	34.48	6.20	36.90	6.73	39.32	7.28	44.15	8.47	48.98	9.74
	27(80.6)	24.82	4.58	29.65	5.54	34.48	6.60	36.90	7.18	39.32	7.77	44.15	9.03	48.98	10.39
	29(84.2)	24.82	4.83	29.65	5.87	34.48	7.03	36.90	7.64	39.32	8.27	44.15	9.64	48.98	11.10
	31(87.8)	24.82	5.13	29.65	6.22	34.48	7.46	36.90	8.12	39.32	8.80	44.15	10.24	48.98	11.81
	33(91.4)	24.82	5.41	29.65	6.60	34.48	7.92	36.90	8.62	39.32	9.36	44.15	10.90	48.98	12.60
35(95)	24.82	5.74	29.65	7.01	34.48	8.40	36.90	9.16	39.32	9.94	44.15	11.61	48.98	13.41	
37(98.6)	24.82	6.07	29.65	7.41	34.48	8.90	36.90	9.71	39.32	10.55	44.15	12.34	48.98	14.27	
39(102.2)	24.82	6.40	29.65	7.84	34.48	9.43	36.90	10.29	39.32	11.21	44.15	13.10	48.98	15.18	
41(105.8)	24.82	6.61	29.65	8.18	34.48	9.78	36.90	10.71	39.32	11.62	44.15	13.72	48.98	15.86	
43(109.4)	24.82	6.81	29.65	8.52	34.48	10.12	36.90	11.03	39.32	12.02	44.15	14.30	48.98	16.55	
45(113)	24.82	7.13	29.65	8.96	34.48	10.53	36.90	11.44	39.32	12.62	44.15	14.94	48.98	17.47	
48(118.4)	24.82	7.68	29.65	9.56	34.48	11.08	36.90	12.13	39.32	13.60	44.15	15.74	48.98	18.84	

**Cooling capacity table**

**MVD-V5X615W/V2GN1**

TC: Total Capacity (kW); PI: Power Input (kW) (Compressor + Outdoor fan motor)

Combination (%)	Outdoor temperature (°C(°F) DB)	Indoor temperature(°C(°F))													
		DB:20.8(69.4) WB:14(57.2)		DB:23.3(73.9) WB:16(60.8)		DB:25.8(78.4) WB:18(64.4)		DB:27(80.6) WB:19(66.2)		DB:28.2(82.8) WB:20(68)		DB:30.7(87.3) WB:22(71.6)		DB:32(89.6) WB:24(75.2)	
		TC	PI	TC	PI	TC	PI	TC	PI	TC	PI	TC	PI	TC	PI
		kW	kW	kW	kW	kW	kW	kW	kW	kW	kW	kW	kW	kW	kW
50%	-5(23)	20.76	3.04	24.82	3.51	28.77	4.04	30.75	4.23	32.73	4.46	36.68	5.07	40.85	5.46
	-2(28.4)	20.76	3.06	24.82	3.58	28.77	4.08	30.75	4.28	32.73	4.54	36.68	5.14	40.85	5.54
	0(32)	20.76	3.11	24.82	3.64	28.77	4.15	30.75	4.34	32.73	4.59	36.68	5.22	40.85	5.63
	2(35.6)	20.76	3.15	24.82	3.69	28.77	4.23	30.75	4.41	32.73	4.67	36.68	5.24	40.85	5.74
	4(39.2)	20.76	3.19	24.82	3.75	28.77	4.27	30.75	4.46	32.73	4.76	36.68	5.38	40.85	5.89
	6(42.8)	20.76	3.24	24.82	3.81	28.77	4.33	30.75	4.56	32.73	4.85	36.68	5.46	40.85	6.06
	8(46.4)	20.76	3.32	24.82	3.88	28.77	4.41	30.75	4.66	32.73	4.92	36.68	5.55	40.85	6.26
	10(50)	20.76	3.39	24.82	3.92	28.77	4.48	30.75	4.74	32.73	5.06	36.68	5.69	40.85	6.35
	12(53.6)	20.76	3.42	24.82	3.97	28.77	4.55	30.75	4.83	32.73	5.16	36.68	5.79	40.85	6.45
	14(57.2)	20.76	3.47	24.82	4.02	28.77	4.60	30.75	4.93	32.73	5.24	36.68	5.89	40.85	6.58
	16(60.8)	20.76	3.52	24.82	4.07	28.77	4.68	30.75	5.01	32.73	5.31	36.68	5.99	40.85	6.68
	18(64.4)	20.76	3.57	24.82	4.15	28.77	4.76	30.75	5.08	32.73	5.41	36.68	6.10	40.85	6.80
	20(68)	20.76	3.62	24.82	4.20	28.77	4.83	30.75	5.16	32.73	5.51	36.68	6.20	40.85	6.93
	21(69.8)	20.76	3.64	24.82	4.25	28.77	4.88	30.75	5.21	32.73	5.56	36.68	6.27	40.85	7.01
	23(73.4)	20.76	3.69	24.82	4.30	28.77	4.96	30.75	5.31	32.73	5.67	36.68	6.37	40.85	7.16
	25(77)	20.76	3.74	24.82	4.38	28.77	5.06	30.75	5.41	32.73	5.84	36.68	6.70	40.85	7.64
	27(80.6)	20.76	3.82	24.82	4.55	28.77	5.34	30.75	5.77	32.73	6.20	36.68	7.13	40.85	8.14
	29(84.2)	20.76	4.02	24.82	4.81	28.77	5.67	30.75	6.12	32.73	6.60	36.68	7.59	40.85	8.68
	31(87.8)	20.76	4.25	24.82	5.08	28.77	5.99	30.75	6.50	32.73	7.01	36.68	8.07	40.85	9.23
	33(91.4)	20.76	4.50	24.82	5.39	28.77	6.37	30.75	6.88	32.73	7.44	36.68	8.57	40.85	9.81
35(95)	20.76	4.76	24.82	5.69	28.77	6.73	30.75	7.28	32.73	7.87	36.68	9.11	40.85	10.42	
37(98.6)	20.76	5.01	24.82	6.02	28.77	7.13	30.75	7.71	32.73	8.35	36.68	9.66	40.85	11.08	
39(102.2)	20.76	5.29	24.82	6.35	28.77	7.54	30.75	8.17	32.73	8.85	36.68	10.24	40.85	11.76	
41(105.8)	20.76	5.51	24.82	6.62	28.77	7.81	30.75	8.55	32.73	9.24	36.68	10.79	40.85	12.31	
43(109.4)	20.76	5.87	24.82	7.08	28.77	8.08	30.75	8.93	32.73	9.47	36.68	11.34	40.85	12.85	
45(113)	20.76	6.00	24.82	7.26	28.77	8.63	30.75	9.63	32.73	9.87	36.68	12.43	40.85	13.95	
48(118.4)	20.76	6.41	24.82	7.81	28.77	8.99	30.75	10.06	32.73	10.16	36.68	13.16	40.85	14.68	

7.2 Heating capacity tables

MVD-V5X252W/V2GN1

TC: Total Capacity (kW); PI: Power Input (kW) (Compressor + Outdoor fan motor)

Combination (%)	Outdoor temperature		Indoor temperature(°C(°F) DB)											
			16(60.8)		18(64.4)		20(68)		21(69.8)		22(71.6)		24(75.2)	
	°C(°F) DB	°C(°F) WB	TC	PI	TC	PI	TC	PI	TC	PI	TC	PI	TC	PI
130%	-19.8(-3.6)	-20(-4)	17.48	4.20	17.40	4.49	17.32	4.79	17.32	4.94	17.23	5.09	17.23	5.39
	-18.8(-1.8)	-19(-2.2)	17.74	4.29	17.66	4.58	17.66	4.88	17.57	5.02	17.57	5.16	17.48	5.46
	-16.7(1.9)	-17(1.4)	18.43	4.49	18.34	4.77	18.26	5.05	18.26	5.19	18.26	5.33	18.17	5.61
	-13.7(7.3)	-15(5)	19.20	4.70	19.12	4.97	19.03	5.24	19.03	5.37	18.94	5.51	18.94	5.78
	-11.8(10.8)	-13(8.6)	19.97	4.91	19.97	5.17	19.89	5.43	19.80	5.56	19.80	5.69	19.71	5.94
	-9.8(14.4)	-11(12.2)	20.92	5.12	20.83	5.37	20.74	5.62	20.74	5.74	20.74	5.86	20.66	6.11
	-9.5(14.9)	-10(14)	21.43	5.23	21.34	5.47	21.26	5.71	21.26	5.83	21.17	5.95	21.17	6.19
	-8.5(16.7)	-9.1(15.6)	21.86	5.33	21.77	5.56	21.77	5.80	21.69	5.91	21.69	6.03	21.60	6.27
	-7(19.4)	-7.6(18.3)	22.63	5.48	22.63	5.71	22.54	5.93	22.54	6.05	22.46	6.16	22.37	6.39
	-5(23)	-5.6(21.9)	23.83	5.69	23.74	5.90	23.66	6.12	23.66	6.23	23.57	6.33	23.57	6.54
	-3(26.6)	-3.7(25.3)	24.94	5.87	24.86	6.08	24.86	6.28	24.77	6.39	24.77	6.49	24.68	6.69
	0(32)	-0.7(30.7)	26.91	6.16	26.91	6.35	26.83	6.54	26.83	6.61	26.74	6.73	26.74	6.91
	3(37.4)	2.2(36)	29.05	6.41	28.97	6.59	28.89	6.77	28.89	6.85	28.89	6.95	28.80	7.12
	5(41)	4.1(39.4)	30.51	6.58	30.43	6.74	30.43	6.91	30.34	6.99	30.34	7.08	30.26	7.24
	7(44.6)	6(42.8)	32.06	6.73	31.97	6.88	31.97	7.05	31.88	7.12	31.88	7.20	30.60	6.91
9(48.2)	7.9(46.2)	33.68	6.87	33.60	7.02	33.60	7.17	33.51	7.25	32.83	7.09	30.60	6.50	
11(51.8)	9.8(49.6)	35.40	7.01	35.31	7.15	35.14	7.24	33.94	6.95	32.83	6.67	30.60	6.12	
13(55.4)	11.8(53.2)	37.28	7.14	37.20	7.28	35.14	6.78	33.94	6.51	32.83	6.26	30.60	5.74	
15(59)	13.7(56.7)	39.08	7.26	37.37	6.89	35.14	6.39	33.94	6.14	32.83	5.90	30.60	5.42	
120%	-19.8(-3.6)	-20(-4)	17.40	4.37	17.31	4.62	17.23	4.89	17.23	5.01	17.23	5.14	17.14	5.41
	-18.8(-1.8)	-19(-2.2)	17.66	4.45	17.57	4.70	17.57	4.96	17.49	5.09	17.49	5.22	17.40	5.47
	-16.7(1.9)	-17(1.4)	18.34	4.62	18.26	4.87	18.14	5.11	18.17	5.24	18.17	5.36	18.09	5.60
	-13.7(7.3)	-15(5)	19.12	4.81	19.03	5.04	18.94	5.28	18.94	5.40	18.94	5.52	18.86	5.75
	-11.8(10.8)	-13(8.6)	19.89	4.99	19.89	5.22	19.80	5.44	19.80	5.56	19.72	5.67	19.72	5.90
	-9.8(14.4)	-11(12.2)	20.83	5.18	20.74	5.39	20.74	5.61	20.66	5.72	20.66	5.83	20.57	6.04
	-9.5(14.9)	-10(14)	21.35	5.28	21.26	5.49	21.17	5.69	21.17	5.80	21.17	5.91	21.09	6.12
	-8.5(16.7)	-9.1(15.6)	21.77	5.36	21.69	5.56	21.69	5.77	21.60	5.87	21.60	5.98	21.51	6.18
	-7(19.4)	-7.6(18.3)	22.54	5.49	22.54	5.69	22.46	5.89	22.46	5.99	22.37	6.09	22.37	6.29
	-5(23)	-5.6(21.9)	23.74	5.67	23.66	5.86	23.57	6.05	23.57	6.15	23.57	6.24	23.49	6.43
	-3(26.6)	-3.7(25.3)	24.86	5.84	24.86	6.02	24.77	6.20	24.77	6.29	24.69	6.38	24.69	6.56
	0(32)	-0.7(30.7)	26.83	6.09	26.83	6.26	26.74	6.42	26.74	6.51	26.66	6.59	26.66	6.76
	3(37.4)	2.2(36)	28.97	6.32	28.89	6.47	28.89	6.62	28.80	6.70	28.80	6.78	28.20	6.74
	5(41)	4.1(39.4)	30.43	6.45	30.34	6.60	30.34	6.75	30.26	6.82	30.26	6.89	28.20	6.33
	7(44.6)	6(42.8)	31.97	6.59	31.97	6.73	31.89	6.87	31.37	6.77	30.34	6.49	28.20	5.96
9(48.2)	7.9(46.2)	33.60	6.72	33.52	6.85	32.40	6.62	31.37	6.36	30.34	6.10	28.20	5.60	
11(51.8)	9.8(49.6)	35.31	6.84	34.46	6.72	32.40	6.23	31.37	5.99	30.34	5.74	28.20	5.28	
13(55.4)	11.8(53.2)	36.60	6.77	34.46	6.30	32.40	5.84	31.37	5.62	30.34	5.40	28.20	4.97	
15(59)	13.7(56.7)	36.60	6.37	34.46	5.93	32.40	5.51	31.37	5.30	30.34	5.09	28.20	4.69	
110%	-19.8(-3.6)	-20(-4)	17.31	4.87	17.23	5.11	17.14	5.36	17.14	5.48	17.15	5.60	17.06	5.85
	-18.8(-1.8)	-19(-2.2)	17.57	4.95	17.49	5.19	17.49	5.43	17.49	5.55	17.40	5.67	17.40	5.91
	-16.7(1.9)	-17(1.4)	18.26	5.11	18.17	5.35	18.43	5.58	18.09	5.69	18.09	5.81	18.00	6.04
	-13.7(7.3)	-15(5)	19.03	5.29	18.95	5.51	18.86	5.73	18.86	5.84	18.86	5.96	18.77	6.17
	-11.8(10.8)	-13(8.6)	19.80	5.47	19.80	5.68	19.71	5.89	19.71	5.99	19.63	6.10	19.63	6.32
	-9.8(14.4)	-11(12.2)	20.74	5.64	20.66	5.84	20.66	6.05	20.57	6.15	20.57	6.25	20.57	6.45
	-9.5(14.9)	-10(14)	21.26	5.73	21.17	5.93	21.08	6.13	21.08	6.23	21.08	6.32	21.00	6.52
	-8.5(16.7)	-9.1(15.6)	21.69	5.81	21.60	6.00	21.60	6.20	21.51	6.29	21.51	6.39	21.51	6.83
	-7(19.4)	-7.6(18.3)	22.46	5.94	22.46	6.12	22.37	6.31	22.37	6.41	22.37	6.50	22.29	6.68
	-5(23)	-5.6(21.9)	23.66	6.11	23.57	6.29	23.49	6.46	23.49	6.55	23.49	6.64	23.40	6.82
	-3(26.6)	-3.7(25.3)	24.77	6.26	24.77	6.43	24.69	6.60	24.69	6.68	24.60	6.77	24.60	6.94
	0(32)	-0.7(30.7)	26.74	6.50	26.74	6.65	26.66	6.81	26.66	6.89	26.66	6.97	25.89	6.83
	3(37.4)	2.2(36)	28.89	6.72	28.80	6.86	28.80	7.00	28.71	7.07	27.77	6.78	25.89	6.22
	5(41)	4.1(39.4)	30.34	6.84	30.34	6.99	29.74	6.92	28.71	6.64	27.77	6.38	25.89	5.85
	7(44.6)	6(42.8)	31.88	6.97	31.63	7.02	29.74	6.50	28.71	6.24	27.77	5.99	25.89	5.50
9(48.2)	7.9(46.2)	33.51	7.08	31.63	6.59	29.74	6.11	28.71	5.87	27.77	5.64	25.89	5.19	
11(51.8)	9.8(49.6)	33.51	6.66	31.63	6.20	29.74	5.75	28.71	5.53	27.77	5.32	25.89	4.90	
13(55.4)	11.8(53.2)	33.51	6.25	31.63	5.82	29.74	5.41	28.71	5.20	27.77	5.00	25.89	4.61	
15(59)	13.7(56.7)	33.51	5.55	31.63	5.49	29.74	5.11	28.71	4.91	27.77	4.73	25.89	4.36	

**Heating capacity tables**

**MVD-V5X252W/V2GN1**

**TC:** Total Capacity (kW); **PI:** Power Input (kW) (Compressor + Outdoor fan motor)

Combination (%)	Outdoor temperature		Indoor temperature(°C(°F) DB)											
			16(60.8)		18(64.4)		20(68)		21(69.8)		22(71.6)		24(75.2)	
	°C(°F) DB	°C(°F) WB	TC	PI	TC	PI	TC	PI	TC	PI	TC	PI	TC	PI
100%	-19.8(-3.6)	-20(-4)	17.23	5.26	17.14	5.48	17.14	5.71	17.06	5.82	17.06	5.92	16.97	6.15
	-18.8(-1.8)	-19(-2.2)	17.49	5.33	17.49	5.55	17.40	5.77	17.40	5.88	17.32	5.99	17.32	6.21
	-16.7(1.9)	-17(1.4)	18.17	5.48	18.08	5.69	18.08	5.90	18.00	6.01	18.00	6.11	18.00	6.32
	-13.7(7.3)	-15(5)	18.94	5.64	18.86	5.84	18.77	6.05	18.77	6.15	18.77	6.25	18.69	6.45
	-11.8(10.8)	-13(8.6)	19.72	5.81	19.72	5.99	19.63	6.19	19.63	6.29	19.63	6.38	19.54	6.58
	-9.8(14.4)	-11(12.2)	20.66	5.96	20.57	6.15	20.57	6.33	20.57	6.43	20.48	6.52	20.48	6.70
	-9.5(14.9)	-10(14)	21.17	6.05	21.09	6.23	21.09	6.41	21.00	6.50	21.00	6.59	20.91	6.77
	-8.5(16.7)	-9.1(15.6)	21.60	6.11	21.51	6.29	21.51	6.47	21.51	6.56	21.43	6.65	21.43	6.82
	-7(19.4)	-7.6(18.3)	22.37	6.23	22.37	6.41	22.29	6.57	22.29	6.66	22.29	6.74	22.20	6.92
	-5(23)	-5.6(21.9)	23.57	6.39	23.48	6.55	23.48	6.71	23.40	6.79	23.40	6.87	23.31	7.04
	-3(26.6)	-3.7(25.3)	24.69	6.53	24.69	5.93	24.60	6.84	24.60	6.92	24.60	6.99	23.57	6.70
	0(32)	-0.7(30.7)	26.66	6.74	26.66	6.89	26.57	7.03	26.14	6.92	25.29	6.63	23.57	6.08
	3(37.4)	2.2(36)	28.80	6.94	28.71	7.07	27.00	6.54	26.14	6.29	25.29	6.04	23.57	5.54
	5(41)	4.1(39.4)	30.26	7.07	28.71	6.64	27.00	6.15	26.14	5.92	25.29	5.68	23.57	5.23
	7(44.6)	6(42.8)	30.43	6.71	28.71	6.24	27.00	5.79	26.14	5.57	25.29	5.35	23.57	4.92
9(48.2)	7.9(46.2)	30.43	6.30	28.71	5.87	27.00	5.45	26.14	5.18	25.29	5.05	23.57	4.65	
11(51.8)	9.8(49.6)	30.43	5.93	28.71	5.53	27.00	5.14	26.14	4.95	25.29	4.76	23.57	4.39	
13(55.4)	11.8(53.2)	30.43	5.57	28.71	5.20	27.00	4.84	26.14	4.66	25.29	4.49	23.57	4.14	
15(59)	13.7(56.7)	30.43	5.26	28.71	4.91	27.00	4.57	26.14	4.41	25.29	4.24	23.57	3.93	
90%	-19.8(-3.6)	-20(-4)	17.11	5.65	17.03	5.85	17.03	6.05	16.94	6.15	16.94	6.26	16.94	6.45
	-18.8(-1.8)	-19(-2.2)	17.37	5.71	17.37	5.92	17.28	6.11	17.28	6.21	17.28	6.31	17.20	6.50
	-16.7(1.9)	-17(1.4)	18.05	5.86	17.97	6.05	17.97	6.23	17.97	6.33	17.88	6.42	17.88	6.61
	-13.7(7.3)	-15(5)	18.82	6.00	18.74	6.18	18.74	6.36	18.65	6.45	18.65	6.54	18.65	6.72
	-11.8(10.8)	-13(8.6)	19.59	6.14	19.59	6.32	19.51	6.49	19.51	6.58	19.51	6.66	19.42	6.84
	-9.8(14.4)	-11(12.2)	20.54	6.29	20.54	6.45	20.45	6.62	20.45	6.70	20.45	6.79	20.36	6.96
	-9.5(14.9)	-10(14)	21.05	6.36	20.96	6.53	20.96	6.68	20.88	6.77	20.88	6.85	20.88	7.01
	-8.5(16.7)	-9.1(15.6)	21.48	6.43	21.48	6.59	21.39	6.74	21.39	6.82	21.39	6.90	21.13	6.97
	-7(19.4)	-7.6(18.3)	22.25	6.53	22.25	6.68	22.16	6.84	22.16	6.92	22.16	6.99	21.13	6.65
	-5(23)	-5.6(21.9)	23.44	6.68	23.36	6.82	23.36	6.96	23.27	7.04	22.67	6.82	21.13	6.26
	-3(26.6)	-3.7(25.3)	24.56	6.81	24.56	6.94	24.30	6.97	23.44	6.69	22.67	6.42	21.13	5.89
	0(32)	-0.7(30.7)	26.61	7.00	25.84	6.83	24.30	6.32	23.44	6.08	22.67	5.84	21.13	5.36
	3(37.4)	2.2(36)	27.38	6.67	25.84	6.21	24.30	5.76	23.44	5.54	22.67	5.32	21.13	4.90
	5(41)	4.1(39.4)	27.38	6.27	25.84	5.84	24.30	5.43	23.44	5.22	22.67	5.02	21.13	4.62
	7(44.6)	6(42.8)	27.38	5.89	25.84	5.50	24.30	5.11	23.44	4.92	22.67	4.74	21.13	4.37
9(48.2)	7.9(46.2)	27.38	5.56	25.84	5.18	24.30	4.82	23.44	4.65	22.67	4.47	21.13	4.13	
11(51.8)	9.8(49.6)	27.38	5.23	25.84	4.89	24.30	4.56	23.44	4.39	22.67	4.23	21.13	3.91	
13(55.4)	11.8(53.2)	27.38	4.92	25.84	4.61	24.30	4.29	23.44	4.14	22.67	3.99	21.13	3.69	
15(59)	13.7(56.7)	27.38	4.65	25.84	4.35	24.30	4.07	23.44	3.92	22.67	3.78	21.13	3.50	
80%	-19.8(-3.6)	-20(-4)	17.06	6.05	16.97	6.22	16.97	6.40	16.97	6.49	16.88	6.58	16.88	6.75
	-18.8(-1.8)	-19(-2.2)	17.31	6.10	17.31	6.28	17.23	6.45	17.23	6.54	17.23	6.62	17.14	6.81
	-16.7(1.9)	-17(1.4)	18.00	6.23	17.92	6.39	17.92	6.56	17.92	6.65	17.92	6.73	17.83	6.90
	-13.7(7.3)	-15(5)	18.77	6.35	18.69	6.51	18.69	6.68	18.69	6.75	18.60	6.83	18.60	7.00
	-11.8(10.8)	-13(8.6)	19.54	6.48	19.54	6.64	19.46	6.79	19.46	6.86	19.46	6.95	18.86	6.76
	-9.8(14.4)	-11(12.2)	20.49	6.61	20.49	6.76	20.40	6.91	20.40	6.98	20.23	6.96	18.86	6.38
	-9.5(14.9)	-10(14)	21.00	6.68	20.91	6.82	20.92	6.96	20.92	7.04	20.23	6.76	18.86	6.20
	-8.5(16.7)	-9.1(15.6)	21.43	6.74	19.92	6.88	21.34	7.02	20.92	6.86	20.23	6.58	18.86	6.03
	-7(19.4)	-7.6(18.3)	22.20	6.83	22.20	6.97	21.60	6.82	20.92	6.55	20.23	6.29	18.86	5.77
	-5(23)	-5.6(21.9)	23.40	6.96	22.97	6.92	21.60	6.41	20.92	6.16	20.23	5.91	18.86	5.43
	-3(26.6)	-3.7(25.3)	24.34	6.99	22.97	6.51	21.60	6.03	20.92	5.80	20.23	5.57	18.86	5.13
	0(32)	-0.7(30.7)	24.34	6.35	22.97	5.91	21.60	5.49	20.92	5.29	20.23	5.08	18.86	4.68
	3(37.4)	2.2(36)	24.34	5.78	22.97	5.39	21.60	5.02	20.92	4.83	20.23	4.65	18.86	4.29
	5(41)	4.1(39.4)	24.34	5.44	22.97	5.08	21.60	4.73	20.92	4.56	20.23	4.39	18.86	4.05
	7(44.6)	6(42.8)	24.34	5.13	22.97	4.80	21.60	4.47	20.92	4.31	20.23	4.15	18.86	3.83
9(48.2)	7.9(46.2)	24.34	4.84	22.97	4.53	21.60	4.22	20.92	4.07	20.23	3.93	18.86	3.63	
11(51.8)	9.8(49.6)	24.34	4.57	22.97	4.28	21.60	3.99	20.92	3.85	20.23	3.71	18.86	3.44	
13(55.4)	11.8(53.2)	24.34	4.31	22.97	4.04	21.60	3.77	20.92	3.64	20.23	3.51	18.86	3.26	
15(59)	13.7(56.7)	24.34	4.08	22.97	3.83	21.60	3.58	20.92	3.45	20.23	3.33	18.86	3.10	

**Heating capacity tables**

**MVD-V5X252W/V2GN1**

TC: Total Capacity (kW); PI: Power Input (kW) (Compressor + Outdoor fan motor)

Combination (%)	Outdoor temperature		Indoor temperature(°C(°F) DB)											
			16(60.8)		18(64.4)		20(68)		21(69.8)		22(71.6)		24(75.2)	
	°C(°F) DB	°C(°F) WB	TC	PI	TC	PI	TC	PI	TC	PI	TC	PI	TC	PI
70%	-19.8(-3.6)	-20(-4)	16.93	6.44	16.85	6.59	16.85	6.74	16.85	6.82	16.85	6.90	16.42	6.83
	-18.8(-1.8)	-19(-2.2)	17.19	6.49	17.19	6.64	17.10	6.79	17.10	6.86	17.10	6.95	16.42	6.68
	-16.7(1.9)	-17(1.4)	17.87	6.59	17.87	6.74	17.79	6.89	17.79	6.96	17.62	6.20	16.42	6.38
	-13.7(7.3)	-15(5)	18.64	6.71	18.56	6.85	18.56	6.99	18.22	6.89	17.62	6.61	16.42	6.06
	-11.8(10.8)	-13(8.6)	19.41	6.82	19.41	6.95	18.90	6.79	18.22	6.53	17.62	6.26	16.42	5.74
	-9.8(14.4)	-11(12.2)	20.35	6.93	20.10	6.92	18.90	6.41	18.22	6.17	17.62	5.92	16.42	5.44
	-9.5(14.9)	-10(14)	20.87	6.99	20.10	6.72	18.90	6.23	18.22	5.99	17.62	5.75	16.42	5.29
	-8.5(16.7)	-9.1(15.6)	21.29	7.03	20.10	6.54	18.90	6.06	18.22	5.83	17.62	5.60	16.42	5.15
	-7(19.4)	-7.6(18.3)	21.29	6.71	20.10	6.25	18.90	5.80	18.22	5.58	17.62	5.36	16.42	4.93
	-5(23)	-5.6(21.9)	21.29	6.31	20.10	5.88	18.90	5.46	18.22	5.25	17.62	6.20	16.42	4.65
	-3(26.6)	-3.7(25.3)	21.29	5.94	20.10	5.54	18.90	5.15	18.22	4.96	17.62	4.77	16.42	4.40
	0(32)	-0.7(30.7)	21.29	5.41	20.10	5.05	18.90	4.70	18.22	4.53	17.62	4.36	16.42	4.03
	3(37.4)	2.2(36)	21.29	4.94	20.10	4.62	18.90	4.31	18.22	4.15	17.62	4.00	16.42	3.70
	5(41)	4.1(39.4)	21.29	4.66	20.10	4.36	18.90	4.08	18.22	3.92	17.62	3.78	16.42	3.50
	7(44.6)	6(42.8)	21.29	4.41	20.10	4.13	18.90	3.85	18.22	3.71	17.62	3.59	16.42	3.32
9(48.2)	7.9(46.2)	21.29	4.17	20.10	3.90	18.90	3.65	18.22	3.52	17.62	3.40	16.42	3.15	
11(51.8)	9.8(49.6)	21.29	3.94	20.10	3.69	18.90	3.46	18.22	3.34	17.62	3.23	16.42	2.99	
13(55.4)	11.8(53.2)	21.29	3.72	20.10	3.50	18.90	3.27	18.22	3.17	17.62	3.05	16.42	2.84	
15(59)	13.7(56.7)	21.29	3.53	20.10	3.32	18.90	3.11	18.22	3.01	17.62	2.90	16.42	2.71	
60%	-19.8(-3.6)	-20(-4)	16.89	6.83	16.80	6.95	16.20	6.69	15.69	6.43	15.17	6.17	14.14	5.66
	-18.8(-1.8)	-19(-2.2)	17.14	6.87	17.14	7.00	16.20	6.55	15.69	6.29	15.17	6.04	14.14	5.54
	-16.7(1.9)	-17(1.4)	17.83	6.96	17.23	6.74	16.20	6.25	15.69	6.01	15.17	5.77	14.14	5.30
	-13.7(7.3)	-15(5)	18.26	6.89	17.23	6.41	16.20	5.94	15.69	5.71	15.17	5.49	14.14	5.05
	-11.8(10.8)	-13(8.6)	18.26	6.52	17.23	6.07	16.20	5.63	15.69	5.42	15.17	5.21	14.14	4.82
	-9.8(14.4)	-11(12.2)	18.26	6.16	17.23	5.74	16.20	5.33	15.69	5.13	15.17	4.93	14.14	4.55
	-9.5(14.9)	-10(14)	18.26	5.99	17.23	5.58	16.20	5.18	15.69	4.99	15.17	4.80	14.14	4.42
	-8.5(16.7)	-9.1(15.6)	18.26	5.83	17.23	5.44	16.20	5.05	15.69	4.86	15.17	4.68	14.14	4.32
	-7(19.4)	-7.6(18.3)	18.26	5.57	17.23	5.20	16.20	4.83	15.69	4.66	15.17	4.48	14.14	4.14
	-5(23)	-5.6(21.9)	18.26	5.25	17.23	4.90	16.20	4.56	15.69	4.40	15.17	4.23	14.14	3.92
	-3(26.6)	-3.7(25.3)	18.26	4.95	17.23	4.63	16.20	4.32	15.69	4.17	15.17	4.01	14.14	3.71
	0(32)	-0.7(30.7)	18.26	4.53	17.23	4.24	16.20	3.96	15.69	3.82	15.17	3.68	14.14	3.41
	3(37.4)	2.2(36)	18.26	4.15	17.23	3.89	16.20	3.64	15.69	3.51	15.17	3.39	14.14	3.14
	5(41)	4.1(39.4)	18.26	3.93	17.23	3.68	16.20	3.44	15.69	3.33	15.17	3.21	14.14	2.98
	7(44.6)	6(42.8)	18.26	3.71	17.23	3.49	16.20	3.26	15.69	3.16	15.17	3.05	14.14	2.83
9(48.2)	7.9(46.2)	18.26	3.52	17.23	3.31	16.20	3.10	15.69	3.00	15.17	2.89	14.14	2.70	
11(51.8)	9.8(49.6)	18.26	3.34	17.23	3.14	16.20	2.95	15.69	2.85	15.17	2.75	14.14	2.57	
13(55.4)	11.8(53.2)	18.26	3.16	17.23	2.98	16.20	2.80	15.69	2.71	15.17	2.62	14.14	2.44	
15(59)	13.7(56.7)	18.26	3.01	17.23	2.83	16.20	2.66	15.69	2.58	15.17	2.50	14.14	2.33	
50%	-19.8(-3.6)	-20(-4)	15.21	6.21	14.35	5.78	13.50	5.37	12.99	5.17	12.56	4.97	11.71	4.58
	-18.8(-1.8)	-19(-2.2)	15.21	6.08	14.35	5.66	13.50	5.26	12.99	5.06	12.56	4.86	11.71	4.49
	-16.7(1.9)	-17(1.4)	15.21	5.80	14.35	5.41	13.50	5.03	12.99	4.84	12.56	4.66	11.71	4.30
	-13.7(7.3)	-15(5)	15.21	5.52	14.35	5.15	13.50	4.79	12.99	4.62	12.56	4.44	11.71	4.11
	-11.8(10.8)	-13(8.6)	15.21	5.24	14.35	4.89	13.50	4.56	12.99	4.39	12.56	4.23	11.71	3.91
	-9.8(14.4)	-11(12.2)	15.21	4.96	14.35	4.64	13.50	4.32	12.99	4.17	12.56	4.02	11.71	3.71
	-9.5(14.9)	-10(14)	15.21	4.83	14.35	4.51	13.50	4.21	12.99	4.06	12.56	3.91	11.71	3.62
	-8.5(16.7)	-9.1(15.6)	15.21	4.71	14.35	4.41	13.50	4.11	12.99	3.96	12.56	3.82	11.71	3.53
	-7(19.4)	-7.6(18.3)	15.21	4.51	14.35	4.23	13.50	3.94	12.99	3.80	12.56	3.67	11.71	3.40
	-5(23)	-5.6(21.9)	15.21	4.26	14.35	3.99	13.50	3.73	12.99	3.60	12.56	3.47	11.71	3.22
	-3(26.6)	-3.7(25.3)	15.21	4.03	14.35	3.78	13.50	3.53	12.99	3.41	12.56	3.29	11.71	3.06
	0(32)	-0.7(30.7)	15.21	3.70	14.35	3.47	13.50	3.26	12.99	3.14	12.56	3.04	11.71	2.83
	3(37.4)	2.2(36)	15.21	3.41	14.35	3.20	13.50	3.00	12.99	2.90	12.56	2.80	11.71	2.62
	5(41)	4.1(39.4)	15.21	3.23	14.35	3.04	13.50	2.85	12.99	2.76	12.56	2.67	11.71	2.49
	7(44.6)	6(42.8)	15.21	3.07	14.35	2.89	13.50	2.71	12.99	2.62	12.56	2.54	11.71	2.38
9(48.2)	7.9(46.2)	15.21	2.91	14.35	2.74	13.50	2.58	12.99	2.50	12.56	2.42	11.71	2.26	
11(51.8)	9.8(49.6)	15.21	2.77	14.35	2.61	13.50	2.46	12.99	2.38	12.56	2.31	11.71	2.16	
13(55.4)	11.8(53.2)	15.21	2.63	14.35	2.48	13.50	2.34	12.99	2.27	12.56	2.20	11.71	2.06	
15(59)	13.7(56.7)	15.21	2.50	14.35	2.37	13.50	2.23	12.99	2.17	12.56	2.10	11.71	1.97	



**Heating capacity tables**

**MVD-V5X280W/V2GN1**

**TC:** Total Capacity (kW); **PI:** Power Input (kW) (Compressor + Outdoor fan motor)

Combination (%)	Outdoor temperature		Indoor temperature(°C(°F) DB)											
			16(60.8)		18(64.4)		20(68)		21(69.8)		22(71.6)		24(75.2)	
	°C(°F) DB	°C(°F) WB	TC	PI	TC	PI	TC	PI	TC	PI	TC	PI	TC	PI
130%	-19.8(-3.6)	-20(-4)	20.40	5.21	20.30	5.58	20.20	5.95	20.20	6.13	20.10	6.32	20.10	6.69
	-18.8(-1.8)	-19(-2.2)	20.70	5.33	20.60	5.69	20.60	6.06	20.50	6.24	20.50	6.41	20.40	6.78
	-16.7(1.9)	-17(1.4)	21.50	5.58	21.40	5.92	21.30	6.28	21.30	6.45	21.30	6.62	21.20	6.97
	-13.7(7.3)	-15(5)	22.40	5.84	22.30	6.17	22.20	6.51	22.20	6.67	22.10	6.84	22.10	7.18
	-11.8(10.8)	-13(8.6)	23.30	6.09	23.30	6.42	23.20	6.74	23.10	6.90	23.10	7.06	23.00	7.38
	-9.8(14.4)	-11(12.2)	24.40	6.36	24.30	6.67	24.20	6.98	24.20	7.13	24.20	7.28	24.10	7.59
	-9.5(14.9)	-10(14)	25.00	6.50	24.90	6.79	24.80	7.09	24.80	7.24	24.70	7.39	24.70	7.69
	-8.5(16.7)	-9.1(15.6)	25.50	6.61	25.40	6.90	25.40	7.20	25.30	7.34	25.30	7.48	25.20	7.78
	-7(19.4)	-7.6(18.3)	26.40	6.80	26.40	7.09	26.30	7.37	26.30	7.51	26.20	7.65	26.10	7.93
	-5(23)	-5.6(21.9)	27.80	7.06	27.70	7.33	27.60	7.60	27.60	7.73	27.50	7.86	27.50	8.13
	-3(26.6)	-3.7(25.3)	29.10	7.29	29.00	7.55	29.00	7.80	28.90	7.93	28.90	8.06	28.80	8.31
	0(32)	-0.7(30.7)	31.40	7.65	31.40	7.89	31.30	8.12	31.30	8.20	31.20	8.36	31.20	8.59
	3(37.4)	2.2(36)	33.90	7.96	33.80	8.18	33.70	8.40	33.70	8.51	33.70	8.63	33.60	8.84
	5(41)	4.1(39.4)	35.60	8.17	35.50	8.38	35.50	8.58	35.40	8.68	35.40	8.79	35.30	8.99
	7(44.6)	6(42.8)	37.40	8.36	37.30	8.55	37.30	8.75	37.20	8.85	37.20	8.94	35.70	8.59
9(48.2)	7.9(46.2)	39.30	8.53	39.20	8.72	39.20	8.90	39.10	9.00	38.30	8.81	35.70	8.07	
11(51.8)	9.8(49.6)	41.30	8.70	41.20	8.87	41.00	8.99	39.60	8.63	38.30	8.28	35.70	7.60	
13(55.4)	11.8(53.2)	43.50	8.86	43.40	9.04	41.00	8.42	39.60	8.09	38.30	7.77	35.70	7.13	
15(59)	13.7(56.7)	45.60	9.02	43.60	8.56	41.00	7.93	39.60	7.63	38.30	7.32	35.70	6.73	
120%	-19.8(-3.6)	-20(-4)	20.30	5.42	20.20	5.74	20.10	6.07	20.10	6.22	20.10	6.39	20.00	6.71
	-18.8(-1.8)	-19(-2.2)	20.60	5.52	20.50	5.84	20.50	6.16	20.40	6.31	20.40	6.48	20.30	6.80
	-16.7(1.9)	-17(1.4)	21.40	5.74	21.30	6.05	21.17	6.35	21.20	6.51	21.20	6.66	21.10	6.96
	-13.7(7.3)	-15(5)	22.30	5.97	22.20	6.26	22.10	6.55	22.10	6.71	22.10	6.85	22.00	7.14
	-11.8(10.8)	-13(8.6)	23.20	6.20	23.20	6.48	23.10	6.76	23.10	6.91	23.00	7.04	23.00	7.32
	-9.8(14.4)	-11(12.2)	24.30	6.43	24.20	6.70	24.20	6.97	24.10	7.11	24.10	7.23	24.00	7.51
	-9.5(14.9)	-10(14)	24.90	6.55	24.80	6.82	24.70	7.07	24.70	7.21	24.70	7.33	24.60	7.60
	-8.5(16.7)	-9.1(15.6)	25.40	6.65	25.30	6.91	25.30	7.16	25.20	7.29	25.20	7.42	25.10	7.68
	-7(19.4)	-7.6(18.3)	26.30	6.82	26.30	7.07	26.20	7.31	26.20	7.44	26.10	7.56	26.10	7.81
	-5(23)	-5.6(21.9)	27.70	7.04	27.60	7.28	27.50	7.51	27.50	7.63	27.50	7.75	27.40	7.98
	-3(26.6)	-3.7(25.3)	29.00	7.25	29.00	7.48	28.90	7.70	28.90	7.81	28.80	7.93	28.80	8.14
	0(32)	-0.7(30.7)	31.30	7.56	31.30	7.77	31.20	7.97	31.20	8.08	31.10	8.18	31.10	8.39
	3(37.4)	2.2(36)	33.80	7.84	33.70	8.03	33.70	8.23	33.60	8.32	33.60	8.42	32.90	8.37
	5(41)	4.1(39.4)	35.50	8.02	35.40	8.20	35.40	8.38	35.30	8.47	35.30	8.56	32.90	7.86
	7(44.6)	6(42.8)	37.30	8.18	37.30	8.35	37.20	8.53	36.60	8.41	35.40	8.06	32.90	7.40
9(48.2)	7.9(46.2)	39.20	8.34	39.10	8.51	37.80	8.23	36.60	7.90	35.40	7.58	32.90	6.96	
11(51.8)	9.8(49.6)	41.20	8.49	40.20	8.34	37.80	7.73	36.60	7.43	35.40	7.13	32.90	6.56	
13(55.4)	11.8(53.2)	42.70	8.41	40.20	7.82	37.80	7.25	36.60	6.98	35.40	6.71	32.90	6.17	
15(59)	13.7(56.7)	42.70	7.92	40.20	7.37	37.80	6.84	36.60	6.58	35.40	6.32	32.90	5.82	
110%	-19.8(-3.6)	-20(-4)	20.20	6.05	20.10	6.35	20.00	6.66	20.00	6.81	20.01	6.96	19.90	7.27
	-18.8(-1.8)	-19(-2.2)	20.50	6.14	20.40	6.44	20.40	6.74	20.40	6.89	20.30	7.04	20.30	7.34
	-16.7(1.9)	-17(1.4)	21.30	6.35	21.20	6.64	21.50	6.93	21.10	7.07	21.10	7.22	21.00	7.50
	-13.7(7.3)	-15(5)	22.20	6.56	22.10	6.84	22.00	7.12	22.00	7.26	22.00	7.40	21.90	7.67
	-11.8(10.8)	-13(8.6)	23.10	6.79	23.10	7.05	23.00	7.31	23.00	7.44	22.90	7.57	22.90	7.84
	-9.8(14.4)	-11(12.2)	24.20	7.00	24.10	7.26	24.10	7.51	24.00	7.64	24.00	7.76	24.00	8.01
	-9.5(14.9)	-10(14)	24.80	7.12	24.70	7.36	24.60	7.61	24.60	7.73	24.60	7.85	24.50	8.10
	-8.5(16.7)	-9.1(15.6)	25.30	7.21	25.20	7.45	25.20	7.69	25.10	7.82	25.10	7.94	25.10	7.24
	-7(19.4)	-7.6(18.3)	26.20	7.38	26.20	7.60	26.10	7.83	26.10	7.96	26.10	8.07	26.00	8.30
	-5(23)	-5.6(21.9)	27.60	7.58	27.50	7.81	27.40	8.02	27.40	8.13	27.40	8.25	27.30	8.47
	-3(26.6)	-3.7(25.3)	28.90	7.78	28.90	7.98	28.80	8.20	28.80	8.30	28.70	8.40	28.70	8.62
	0(32)	-0.7(30.7)	31.20	8.07	31.20	8.26	31.10	8.46	31.10	8.55	31.10	8.66	30.20	8.49
	3(37.4)	2.2(36)	33.70	8.34	33.60	8.52	33.60	8.69	33.50	8.78	32.40	8.42	30.20	7.72
	5(41)	4.1(39.4)	35.40	8.50	35.40	8.67	34.70	8.59	33.50	8.25	32.40	7.92	30.20	7.27
	7(44.6)	6(42.8)	37.20	8.66	36.90	8.71	34.70	8.07	33.50	7.75	32.40	7.44	30.20	6.84
9(48.2)	7.9(46.2)	39.10	8.80	36.90	8.19	34.70	7.59	33.50	7.29	32.40	7.00	30.20	6.44	
11(51.8)	9.8(49.6)	39.10	8.27	36.90	7.70	34.70	7.14	33.50	6.87	32.40	6.60	30.20	6.08	
13(55.4)	11.8(53.2)	39.10	7.76	36.90	7.23	34.70	6.71	33.50	6.46	32.40	6.21	30.20	5.72	
15(59)	13.7(56.7)	39.10	6.89	36.90	6.82	34.70	6.34	33.50	6.10	32.40	5.87	30.20	5.42	

**Heating capacity tables**

**MVD-V5X280W/V2GN1**

**TC:** Total Capacity (kW); **PI:** Power Input (kW) (Compressor + Outdoor fan motor)

Combination (%)	Outdoor temperature		Indoor temperature(°C(°F) DB)											
			16(60.8)		18(64.4)		20(68)		21(69.8)		22(71.6)		24(75.2)	
	°C(°F) DB	°C(°F) WB	TC	PI	TC	PI	TC	PI	TC	PI	TC	PI	TC	PI
100%	-19.8(-3.6)	-20(-4)	20.10	6.54	20.00	6.81	20.00	7.09	19.90	7.23	19.90	7.36	19.80	7.64
	-18.8(-1.8)	-19(-2.2)	20.40	6.62	20.40	6.89	20.30	7.16	20.30	7.30	20.20	7.44	20.20	7.71
	-16.7(1.9)	-17(1.4)	21.20	6.81	21.10	7.07	21.10	7.33	21.00	7.46	21.00	7.59	21.00	7.85
	-13.7(7.3)	-15(5)	22.10	7.00	22.00	7.26	21.90	7.51	21.90	7.64	21.90	7.76	21.80	8.01
	-11.8(10.8)	-13(8.6)	23.00	7.21	23.00	7.44	22.90	7.68	22.90	7.81	22.90	7.93	22.80	8.17
	-9.8(14.4)	-11(12.2)	24.10	7.40	24.00	7.64	24.00	7.86	24.00	7.98	23.90	8.10	23.90	8.32
	-9.5(14.9)	-10(14)	24.70	7.51	24.60	7.73	24.60	7.96	24.50	8.07	24.50	8.18	24.40	8.40
	-8.5(16.7)	-9.1(15.6)	25.20	7.59	25.10	7.82	25.10	8.03	25.10	8.14	25.00	8.25	25.00	8.47
	-7(19.4)	-7.6(18.3)	26.10	7.74	26.10	7.96	26.00	8.16	26.00	8.27	26.00	8.38	25.90	8.59
	-5(23)	-5.6(21.9)	27.50	7.94	27.40	8.13	27.40	8.34	27.30	8.43	27.30	8.53	27.20	8.74
	-3(26.6)	-3.7(25.3)	28.80	8.11	28.80	7.37	28.70	8.50	28.70	8.59	28.70	8.68	27.50	8.32
	0(32)	-0.7(30.7)	31.10	8.38	31.10	8.55	31.00	8.73	30.50	8.59	29.50	8.24	27.50	7.55
	3(37.4)	2.2(36)	33.60	8.62	33.50	8.78	31.50	8.12	30.50	7.81	29.50	7.50	27.50	6.88
	5(41)	4.1(39.4)	35.30	8.78	33.50	8.25	31.50	7.64	30.50	7.35	29.50	7.06	27.50	6.49
	7(44.6)	6(42.8)	35.50	8.33	33.50	7.75	31.50	7.19	30.50	6.92	29.50	6.65	27.50	6.12
9(48.2)	7.9(46.2)	35.50	7.82	33.50	7.29	31.50	6.77	30.50	6.43	29.50	6.27	27.50	5.77	
11(51.8)	9.8(49.6)	35.50	7.37	33.50	6.87	31.50	6.39	30.50	6.14	29.50	5.91	27.50	5.45	
13(55.4)	11.8(53.2)	35.50	6.92	33.50	6.46	31.50	6.01	30.50	5.79	29.50	5.57	27.50	5.15	
15(59)	13.7(56.7)	35.50	6.53	33.50	6.10	31.50	5.68	30.50	5.47	29.50	5.27	27.50	4.87	
90%	-19.8(-3.6)	-20(-4)	19.96	7.02	19.86	7.26	19.86	7.52	19.77	7.64	19.77	7.77	19.77	8.01
	-18.8(-1.8)	-19(-2.2)	20.26	7.10	20.26	7.35	20.17	7.59	20.17	7.71	20.17	7.83	20.06	8.08
	-16.7(1.9)	-17(1.4)	21.06	7.27	20.96	7.51	20.96	7.74	20.96	7.86	20.86	7.97	20.86	8.21
	-13.7(7.3)	-15(5)	21.96	7.45	21.86	7.68	21.86	7.90	21.76	8.01	21.76	8.12	21.76	8.35
	-11.8(10.8)	-13(8.6)	22.86	7.63	22.86	7.84	22.76	8.06	22.76	8.17	22.76	8.27	22.66	8.49
	-9.8(14.4)	-11(12.2)	23.96	7.81	23.96	8.01	23.86	8.22	23.86	8.32	23.86	8.43	23.76	8.64
	-9.5(14.9)	-10(14)	24.56	7.90	24.46	8.11	24.46	8.30	24.36	8.40	24.36	8.51	24.36	8.70
	-8.5(16.7)	-9.1(15.6)	25.06	7.98	25.06	8.18	24.96	8.38	24.96	8.47	24.96	8.57	24.66	8.66
	-7(19.4)	-7.6(18.3)	25.95	8.11	25.95	8.30	25.86	8.50	25.86	8.59	25.86	8.68	24.66	8.26
	-5(23)	-5.6(21.9)	27.35	8.29	27.25	8.47	27.25	8.65	27.15	8.74	26.45	8.47	24.66	7.77
	-3(26.6)	-3.7(25.3)	28.65	8.45	28.65	8.62	28.35	8.66	27.35	8.31	26.45	7.97	24.66	7.32
	0(32)	-0.7(30.7)	31.05	8.69	30.15	8.48	28.35	7.85	27.35	7.54	26.45	7.25	24.66	6.66
	3(37.4)	2.2(36)	31.94	8.28	30.15	7.71	28.35	7.15	27.35	6.88	26.45	6.61	24.66	6.09
	5(41)	4.1(39.4)	31.94	7.79	30.15	7.25	28.35	6.74	27.35	6.48	26.45	6.24	24.66	5.74
	7(44.6)	6(42.8)	31.94	7.32	30.15	6.84	28.35	6.35	27.35	6.12	26.45	5.88	24.66	5.43
9(48.2)	7.9(46.2)	31.94	6.90	30.15	6.43	28.35	5.99	27.35	5.77	26.45	5.56	24.66	5.13	
11(51.8)	9.8(49.6)	31.94	6.50	30.15	6.07	28.35	5.66	27.35	5.45	26.45	5.25	24.66	4.86	
13(55.4)	11.8(53.2)	31.94	6.12	30.15	5.72	28.35	5.33	27.35	5.14	26.45	4.96	24.66	4.58	
15(59)	13.7(56.7)	31.94	5.78	30.15	5.41	28.35	5.05	27.35	4.87	26.45	4.70	24.66	4.35	
80%	-19.8(-3.6)	-20(-4)	19.90	7.51	19.80	7.72	19.80	7.95	19.80	8.06	19.70	8.17	19.70	8.38
	-18.8(-1.8)	-19(-2.2)	20.20	7.57	20.20	7.80	20.10	8.01	20.10	8.12	20.10	8.23	20.00	8.45
	-16.7(1.9)	-17(1.4)	21.00	7.73	20.90	7.94	20.90	8.15	20.90	8.25	20.90	8.36	20.80	8.56
	-13.7(7.3)	-15(5)	21.90	7.89	21.80	8.09	21.80	8.29	21.80	8.38	21.70	8.49	21.70	8.69
	-11.8(10.8)	-13(8.6)	22.80	8.05	22.80	8.24	22.70	8.43	22.70	8.52	22.70	8.63	22.00	8.39
	-9.8(14.4)	-11(12.2)	23.90	8.21	23.90	8.39	23.80	8.58	23.80	8.67	23.60	8.65	22.00	7.93
	-9.5(14.9)	-10(14)	24.50	8.29	24.40	8.47	24.40	8.65	24.40	8.74	23.60	8.39	22.00	7.69
	-8.5(16.7)	-9.1(15.6)	25.00	8.37	23.24	8.54	24.90	8.71	24.40	8.52	23.60	8.17	22.00	7.49
	-7(19.4)	-7.6(18.3)	25.90	8.49	25.90	8.66	25.20	8.47	24.40	8.13	23.60	7.81	22.00	7.16
	-5(23)	-5.6(21.9)	27.30	8.64	26.80	8.59	25.20	7.96	24.40	7.65	23.60	7.34	22.00	6.74
	-3(26.6)	-3.7(25.3)	28.40	8.68	26.80	8.09	25.20	7.49	24.40	7.21	23.60	6.92	22.00	6.37
	0(32)	-0.7(30.7)	28.40	7.88	26.80	7.34	25.20	6.82	24.40	6.56	23.60	6.30	22.00	5.81
	3(37.4)	2.2(36)	28.40	7.18	26.80	6.70	25.20	6.23	24.40	5.99	23.60	5.77	22.00	5.32
	5(41)	4.1(39.4)	28.40	6.76	26.80	6.31	25.20	5.87	24.40	5.66	23.60	5.45	22.00	5.03
	7(44.6)	6(42.8)	28.40	6.37	26.80	5.96	25.20	5.55	24.40	5.35	23.60	5.15	22.00	4.76
9(48.2)	7.9(46.2)	28.40	6.01	26.80	5.62	25.20	5.24	24.40	5.05	23.60	4.87	22.00	4.51	
11(51.8)	9.8(49.6)	28.40	5.68	26.80	5.31	25.20	4.96	24.40	4.78	23.60	4.61	22.00	4.28	
13(55.4)	11.8(53.2)	28.40	5.35	26.80	5.01	25.20	4.69	24.40	4.52	23.60	4.36	22.00	4.04	
15(59)	13.7(56.7)	28.40	5.06	26.80	4.75	25.20	4.44	24.40	4.29	23.60	4.14	22.00	3.85	

**Heating capacity tables**

**MVD-V5X280W/V2GN1**

TC: Total Capacity (kW); PI: Power Input (kW) (Compressor + Outdoor fan motor)

Combination (%)	Outdoor temperature		Indoor temperature(°C(°F) DB)											
			16(60.8)		18(64.4)		20(68)		21(69.8)		22(71.6)		24(75.2)	
	°C(°F) DB	°C(°F) WB	TC	PI	TC	PI	TC	PI	TC	PI	TC	PI	TC	PI
70%	-19.8(-3.6)	-20(-4)	19.75	7.99	19.66	8.18	19.66	8.38	19.66	8.47	19.66	8.57	19.16	8.48
	-18.8(-1.8)	-19(-2.2)	20.05	8.06	20.05	8.24	19.96	8.43	19.96	8.52	19.96	8.63	19.16	8.30
	-16.7(1.9)	-17(1.4)	20.85	8.19	20.85	8.38	20.75	8.55	20.75	8.65	20.55	7.70	19.16	7.92
	-13.7(7.3)	-15(5)	21.75	8.33	21.65	8.51	21.65	8.68	21.25	8.55	20.55	8.21	19.16	7.53
	-11.8(10.8)	-13(8.6)	22.65	8.47	22.65	8.64	22.05	8.43	21.25	8.10	20.55	7.78	19.16	7.13
	-9.8(14.4)	-11(12.2)	23.75	8.61	23.45	8.60	22.05	7.96	21.25	7.66	20.55	7.35	19.16	6.75
	-9.5(14.9)	-10(14)	24.35	8.68	23.45	8.35	22.05	7.73	21.25	7.43	20.55	7.14	19.16	6.56
	-8.5(16.7)	-9.1(15.6)	24.84	8.73	23.45	8.12	22.05	7.53	21.25	7.24	20.55	6.96	19.16	6.40
	-7(19.4)	-7.6(18.3)	24.84	8.34	23.45	7.76	22.05	7.20	21.25	6.93	20.55	6.66	19.16	6.13
	-5(23)	-5.6(21.9)	24.84	7.83	23.45	7.30	22.05	6.78	21.25	6.52	20.55	6.70	19.16	5.78
	-3(26.6)	-3.7(25.3)	24.84	7.38	23.45	6.88	22.05	6.40	21.25	6.15	20.55	5.92	19.16	5.46
	0(32)	-0.7(30.7)	24.84	6.71	23.45	6.27	22.05	5.84	21.25	5.62	20.55	5.42	19.16	5.00
	3(37.4)	2.2(36)	24.84	6.13	23.45	5.74	22.05	5.35	21.25	5.15	20.55	4.97	19.16	4.59
	5(41)	4.1(39.4)	24.84	5.79	23.45	5.42	22.05	5.06	21.25	4.87	20.55	4.70	19.16	4.35
	7(44.6)	6(42.8)	24.84	5.47	23.45	5.13	22.05	4.78	21.25	4.61	20.55	4.45	19.16	4.13
9(48.2)	7.9(46.2)	24.84	5.17	23.45	4.85	22.05	4.53	21.25	4.37	20.55	4.22	19.16	3.91	
11(51.8)	9.8(49.6)	24.84	4.89	23.45	4.58	22.05	4.29	21.25	4.15	20.55	4.01	19.16	3.72	
13(55.4)	11.8(53.2)	24.84	4.62	23.45	4.34	22.05	4.06	21.25	3.93	20.55	3.79	19.16	3.53	
15(59)	13.7(56.7)	24.84	4.38	23.45	4.12	22.05	3.86	21.25	3.74	20.55	3.60	19.16	3.36	
60%	-19.8(-3.6)	-20(-4)	19.70	8.48	19.60	8.64	18.90	8.31	18.30	7.98	17.70	7.67	16.50	7.03
	-18.8(-1.8)	-19(-2.2)	20.00	8.53	20.00	8.69	18.90	8.13	18.30	7.82	17.70	7.50	16.50	6.88
	-16.7(1.9)	-17(1.4)	20.80	8.65	20.10	8.38	18.90	7.76	18.30	7.46	17.70	7.16	16.50	6.58
	-13.7(7.3)	-15(5)	21.30	8.55	20.10	7.96	18.90	7.38	18.30	7.10	17.70	6.82	16.50	6.27
	-11.8(10.8)	-13(8.6)	21.30	8.10	20.10	7.53	18.90	6.99	18.30	6.73	17.70	6.47	16.50	5.99
	-9.8(14.4)	-11(12.2)	21.30	7.65	20.10	7.12	18.90	6.62	18.30	6.37	17.70	6.13	16.50	5.65
	-9.5(14.9)	-10(14)	21.30	7.43	20.10	6.93	18.90	6.43	18.30	6.20	17.70	5.96	16.50	5.49
	-8.5(16.7)	-9.1(15.6)	21.30	7.24	20.10	6.75	18.90	6.27	18.30	6.04	17.70	5.81	16.50	5.36
	-7(19.4)	-7.6(18.3)	21.30	6.92	20.10	6.46	18.90	6.00	18.30	5.79	17.70	5.57	16.50	5.14
	-5(23)	-5.6(21.9)	21.30	6.52	20.10	6.09	18.90	5.67	18.30	5.46	17.70	5.26	16.50	4.86
	-3(26.6)	-3.7(25.3)	21.30	6.15	20.10	5.75	18.90	5.36	18.30	5.17	17.70	4.98	16.50	4.60
	0(32)	-0.7(30.7)	21.30	5.62	20.10	5.27	18.90	4.91	18.30	4.74	17.70	4.57	16.50	4.23
	3(37.4)	2.2(36)	21.30	5.15	20.10	4.84	18.90	4.52	18.30	4.36	17.70	4.21	16.50	3.90
	5(41)	4.1(39.4)	21.30	4.87	20.10	4.58	18.90	4.28	18.30	4.14	17.70	3.99	16.50	3.71
	7(44.6)	6(42.8)	21.30	4.61	20.10	4.33	18.90	4.05	18.30	3.92	17.70	3.79	16.50	3.52
9(48.2)	7.9(46.2)	21.30	4.37	20.10	4.11	18.90	3.85	18.30	3.73	17.70	3.59	16.50	3.35	
11(51.8)	9.8(49.6)	21.30	4.15	20.10	3.90	18.90	3.66	18.30	3.54	17.70	3.42	16.50	3.19	
13(55.4)	11.8(53.2)	21.30	3.92	20.10	3.70	18.90	3.47	18.30	3.36	17.70	3.25	16.50	3.03	
15(59)	13.7(56.7)	21.30	3.73	20.10	3.51	18.90	3.31	18.30	3.20	17.70	3.10	16.50	2.89	
50%	-19.8(-3.6)	-20(-4)	17.74	7.71	16.75	7.18	15.75	6.67	15.15	6.42	14.65	6.17	13.66	5.69
	-18.8(-1.8)	-19(-2.2)	17.74	7.54	16.75	7.03	15.75	6.54	15.15	6.28	14.65	6.04	13.66	5.57
	-16.7(1.9)	-17(1.4)	17.74	7.20	16.75	6.71	15.75	6.25	15.15	6.01	14.65	5.79	13.66	5.34
	-13.7(7.3)	-15(5)	17.74	6.85	16.75	6.40	15.75	5.95	15.15	5.73	14.65	5.52	13.66	5.10
	-11.8(10.8)	-13(8.6)	17.74	6.51	16.75	6.08	15.75	5.66	15.15	5.45	14.65	5.25	13.66	4.86
	-9.8(14.4)	-11(12.2)	17.74	6.16	16.75	5.76	15.75	5.37	15.15	5.17	14.65	4.99	13.66	4.61
	-9.5(14.9)	-10(14)	17.74	5.99	16.75	5.60	15.75	5.23	15.15	5.04	14.65	4.86	13.66	4.49
	-8.5(16.7)	-9.1(15.6)	17.74	5.85	16.75	5.47	15.75	5.10	15.15	4.92	14.65	4.74	13.66	4.39
	-7(19.4)	-7.6(18.3)	17.74	5.60	16.75	5.25	15.75	4.89	15.15	4.72	14.65	4.56	13.66	4.22
	-5(23)	-5.6(21.9)	17.74	5.28	16.75	4.96	15.75	4.63	15.15	4.47	14.65	4.31	13.66	4.00
	-3(26.6)	-3.7(25.3)	17.74	5.00	16.75	4.70	15.75	4.39	15.15	4.24	14.65	4.09	13.66	3.80
	0(32)	-0.7(30.7)	17.74	4.59	16.75	4.31	15.75	4.04	15.15	3.90	14.65	3.77	13.66	3.51
	3(37.4)	2.2(36)	17.74	4.23	16.75	3.98	15.75	3.73	15.15	3.60	14.65	3.48	13.66	3.25
	5(41)	4.1(39.4)	17.74	4.01	16.75	3.77	15.75	3.54	15.15	3.43	14.65	3.31	13.66	3.09
	7(44.6)	6(42.8)	17.74	3.81	16.75	3.59	15.75	3.37	15.15	3.26	14.65	3.16	13.66	2.95
9(48.2)	7.9(46.2)	17.74	3.61	16.75	3.41	15.75	3.20	15.15	3.11	14.65	3.01	13.66	2.81	
11(51.8)	9.8(49.6)	17.74	3.44	16.75	3.24	15.75	3.05	15.15	2.96	14.65	2.87	13.66	2.68	
13(55.4)	11.8(53.2)	17.74	3.27	16.75	3.08	15.75	2.90	15.15	2.82	14.65	2.73	13.66	2.56	
15(59)	13.7(56.7)	17.74	3.11	16.75	2.94	15.75	2.77	15.15	2.69	14.65	2.61	13.66	2.45	

## Heating capacity tables

## MVD-V5X335W/V2GN1

TC: Total Capacity (kW); PI: Power Input (kW) (Compressor + Outdoor fan motor)

Combination (%)	Outdoor temperature		Indoor temperature(°C(°F) DB)											
			16(60.8)		18(64.4)		20(68)		21(69.8)		22(71.6)		24(75.2)	
	°C(°F) DB	°C(°F) WB	TC	PI	TC	PI	TC	PI	TC	PI	TC	PI	TC	PI
130%	-19.8(-3.6)	-20(-4)	24.28	6.39	24.16	6.84	24.05	7.30	24.05	7.52	23.93	7.75	23.93	8.21
	-18.8(-1.8)	-19(-2.2)	24.64	6.54	24.52	6.98	24.52	7.43	24.40	7.65	24.40	7.86	24.28	8.31
	-16.7(1.9)	-17(1.4)	25.59	6.84	25.47	7.27	25.35	7.70	25.35	7.91	25.35	8.12	25.24	8.55
	-13.7(7.3)	-15(5)	26.66	7.16	26.55	7.57	26.43	7.98	26.43	8.18	26.31	8.39	26.31	8.81
	-11.8(10.8)	-13(8.6)	27.74	7.48	27.74	7.88	27.62	8.26	27.50	8.46	27.50	8.66	27.38	9.05
	-9.8(14.4)	-11(12.2)	29.05	7.81	28.93	8.18	28.81	8.56	28.81	8.75	28.81	8.93	28.69	9.31
	-9.5(14.9)	-10(14)	29.76	7.97	29.64	8.34	29.52	8.70	29.52	8.89	29.40	9.06	29.40	9.43
	-8.5(16.7)	-9.1(15.6)	30.35	8.11	30.24	8.46	30.24	8.83	30.12	9.01	30.12	9.18	30.00	9.55
	-7(19.4)	-7.6(18.3)	31.43	8.35	31.43	8.70	31.31	9.04	31.31	9.22	31.19	9.38	31.07	9.73
	-5(23)	-5.6(21.9)	33.09	8.66	32.97	8.99	32.85	9.32	32.85	9.49	32.74	9.64	32.74	9.97
	-3(26.6)	-3.7(25.3)	34.64	8.95	34.52	9.26	34.52	9.57	34.40	9.73	34.40	9.89	34.28	10.19
	0(32)	-0.7(30.7)	37.38	9.38	37.38	9.67	37.26	9.96	37.26	10.06	37.14	10.25	37.14	10.53
	3(37.4)	2.2(36)	40.35	9.77	40.24	10.04	40.12	10.31	40.12	10.44	40.12	10.58	40.00	10.84
	5(41)	4.1(39.4)	42.38	10.02	42.26	10.27	42.26	10.52	42.14	10.65	42.14	10.78	42.02	11.03
	7(44.6)	6(42.8)	44.52	10.25	44.40	10.49	44.40	10.73	44.28	10.85	44.28	10.97	42.50	10.53
9(48.2)	7.9(46.2)	46.78	10.46	46.66	10.70	46.66	10.92	46.55	11.04	45.59	10.80	42.50	9.90	
11(51.8)	9.8(49.6)	49.16	10.67	49.05	10.89	48.81	11.03	47.14	10.59	45.59	10.16	42.50	9.32	
13(55.4)	11.8(53.2)	51.78	10.87	51.66	11.09	48.81	10.33	47.14	9.92	45.59	9.53	42.50	8.75	
15(59)	13.7(56.7)	54.28	11.06	51.90	10.50	48.81	9.73	47.14	9.36	45.59	8.98	42.50	8.25	
120%	-19.8(-3.6)	-20(-4)	24.17	6.65	24.05	7.04	23.93	7.44	23.93	7.63	23.93	7.84	23.81	8.24
	-18.8(-1.8)	-19(-2.2)	24.53	6.77	24.41	7.17	24.41	7.56	24.29	7.75	24.29	7.95	24.17	8.34
	-16.7(1.9)	-17(1.4)	25.48	7.04	25.36	7.42	25.20	7.79	25.24	7.98	25.24	8.17	25.12	8.54
	-13.7(7.3)	-15(5)	26.55	7.32	26.43	7.68	26.31	8.04	26.31	8.23	26.31	8.40	26.19	8.76
	-11.8(10.8)	-13(8.6)	27.62	7.60	27.62	7.95	27.50	8.29	27.50	8.47	27.38	8.64	27.38	8.98
	-9.8(14.4)	-11(12.2)	28.93	7.89	28.81	8.21	28.81	8.55	28.69	8.72	28.69	8.87	28.57	9.21
	-9.5(14.9)	-10(14)	29.65	8.04	29.53	8.36	29.41	8.67	29.41	8.84	29.41	9.00	29.29	9.32
	-8.5(16.7)	-9.1(15.6)	30.24	8.16	30.12	8.47	30.12	8.78	30.00	8.94	30.00	9.11	29.88	9.42
	-7(19.4)	-7.6(18.3)	31.31	8.37	31.31	8.67	31.19	8.97	31.19	9.13	31.07	9.28	31.07	9.58
	-5(23)	-5.6(21.9)	32.98	8.64	32.86	8.93	32.74	9.22	32.74	9.36	32.74	9.51	32.62	9.79
	-3(26.6)	-3.7(25.3)	34.53	8.90	34.53	9.17	34.41	9.44	34.41	9.58	34.29	9.72	34.29	9.99
	0(32)	-0.7(30.7)	37.26	9.28	37.26	9.53	37.14	9.78	37.14	9.91	37.02	10.03	37.02	10.29
	3(37.4)	2.2(36)	40.24	9.62	40.12	9.86	40.12	10.09	40.00	10.21	40.00	10.32	39.17	10.27
	5(41)	4.1(39.4)	42.26	9.83	42.14	10.06	42.14	10.28	42.02	10.39	42.02	10.50	39.17	9.64
	7(44.6)	6(42.8)	44.41	10.03	44.41	10.25	44.29	10.46	43.57	10.31	42.14	9.89	39.17	9.07
9(48.2)	7.9(46.2)	46.67	10.24	46.55	10.44	45.00	10.09	43.57	9.69	42.14	9.30	39.17	8.54	
11(51.8)	9.8(49.6)	49.05	10.41	47.86	10.24	45.00	9.49	43.57	9.12	42.14	8.75	39.17	8.05	
13(55.4)	11.8(53.2)	50.83	10.31	47.86	9.60	45.00	8.90	43.57	8.56	42.14	8.23	39.17	7.57	
15(59)	13.7(56.7)	50.83	9.71	47.86	9.04	45.00	8.39	43.57	8.07	42.14	7.76	39.17	7.14	
110%	-19.8(-3.6)	-20(-4)	24.05	7.42	23.93	7.79	23.81	8.17	23.81	8.35	23.82	8.53	23.69	8.91
	-18.8(-1.8)	-19(-2.2)	24.41	7.54	24.29	7.90	24.29	8.27	24.29	8.45	24.17	8.64	24.17	9.00
	-16.7(1.9)	-17(1.4)	25.36	7.79	25.24	8.14	25.59	8.50	25.12	8.67	25.12	8.85	25.00	9.20
	-13.7(7.3)	-15(5)	26.43	8.05	26.31	8.40	26.19	8.73	26.19	8.90	26.19	9.07	26.07	9.40
	-11.8(10.8)	-13(8.6)	27.50	8.33	27.50	8.65	27.38	8.97	27.38	9.13	27.26	9.29	27.26	9.62
	-9.8(14.4)	-11(12.2)	28.81	8.59	28.69	8.90	28.69	9.21	28.57	9.37	28.57	9.52	28.57	9.83
	-9.5(14.9)	-10(14)	29.52	8.73	29.40	9.03	29.28	9.34	29.28	9.48	29.28	9.63	29.17	9.93
	-8.5(16.7)	-9.1(15.6)	30.12	8.84	30.00	9.14	30.00	9.44	29.88	9.59	29.88	9.74	29.88	8.88
	-7(19.4)	-7.6(18.3)	31.19	9.05	31.19	9.32	31.07	9.61	31.07	9.76	31.07	9.90	30.95	10.18
	-5(23)	-5.6(21.9)	32.86	9.30	32.74	9.58	32.62	9.84	32.62	9.98	32.62	10.11	32.50	10.39
	-3(26.6)	-3.7(25.3)	34.41	9.54	34.41	9.79	34.29	10.06	34.29	10.18	34.17	10.31	34.17	10.57
	0(32)	-0.7(30.7)	37.14	9.90	37.14	10.14	37.03	10.38	37.03	10.49	37.03	10.62	35.95	10.41
	3(37.4)	2.2(36)	40.12	10.23	40.00	10.45	40.00	10.66	39.88	10.77	38.57	10.33	35.95	9.47
	5(41)	4.1(39.4)	42.14	10.42	42.14	10.64	41.31	10.54	39.88	10.11	38.57	9.71	35.95	8.91
	7(44.6)	6(42.8)	44.28	10.62	43.93	10.69	41.31	9.90	39.88	9.51	38.57	9.13	35.95	8.38
9(48.2)	7.9(46.2)	46.55	10.79	43.93	10.05	41.31	9.31	39.88	8.95	38.57	8.59	35.95	7.90	
11(51.8)	9.8(49.6)	46.55	10.15	43.93	9.45	41.31	8.76	39.88	8.43	38.57	8.10	35.95	7.46	
13(55.4)	11.8(53.2)	46.55	9.52	43.93	8.87	41.31	8.24	39.88	7.93	38.57	7.62	35.95	7.02	
15(59)	13.7(56.7)	46.55	8.45	43.93	8.36	41.31	7.78	39.88	7.48	38.57	7.20	35.95	6.64	

**Heating capacity tables**

**MVD-V5X335W/V2GN1**

**TC:** Total Capacity (kW); **PI:** Power Input (kW) (Compressor + Outdoor fan motor)

Combination (%)	Outdoor temperature		Indoor temperature(°C(°F) DB)											
			16(60.8)		18(64.4)		20(68)		21(69.8)		22(71.6)		24(75.2)	
	°C(°F) DB	°C(°F) WB	TC	PI	TC	PI	TC	PI	TC	PI	TC	PI	TC	PI
100%	-19.8(-3.6)	-20(-4)	23.93	8.02	23.81	8.35	23.81	8.69	23.69	8.87	23.69	9.03	23.57	9.37
	-18.8(-1.8)	-19(-2.2)	24.29	8.12	24.29	8.45	24.17	8.79	24.17	8.96	24.05	9.13	24.05	9.46
	-16.7(1.9)	-17(1.4)	25.24	8.35	25.12	8.67	25.12	8.99	25.00	9.15	25.00	9.31	25.00	9.63
	-13.7(7.3)	-15(5)	26.31	8.59	26.19	8.90	26.07	9.21	26.07	9.37	26.07	9.52	25.95	9.83
	-11.8(10.8)	-13(8.6)	27.38	8.84	27.38	9.13	27.26	9.43	27.26	9.58	27.26	9.72	27.14	10.02
	-9.8(14.4)	-11(12.2)	28.69	9.08	28.57	9.37	28.57	9.64	28.57	9.79	28.45	9.93	28.45	10.21
	-9.5(14.9)	-10(14)	29.40	9.21	29.29	9.48	29.29	9.76	29.17	9.90	29.17	10.03	29.05	10.31
	-8.5(16.7)	-9.1(15.6)	30.00	9.31	29.88	9.59	29.88	9.85	29.88	9.99	29.76	10.13	29.76	10.39
	-7(19.4)	-7.6(18.3)	31.07	9.50	31.07	9.76	30.95	10.01	30.95	10.15	30.95	10.27	30.83	10.54
	-5(23)	-5.6(21.9)	32.74	9.74	32.62	9.98	32.62	10.23	32.50	10.34	32.50	10.47	32.38	10.72
	-3(26.6)	-3.7(25.3)	34.29	9.95	34.29	9.04	34.17	10.42	34.17	10.54	34.17	10.65	32.74	10.21
	0(32)	-0.7(30.7)	37.02	10.27	37.02	10.49	36.90	10.71	36.31	10.54	35.12	10.10	32.74	9.27
	3(37.4)	2.2(36)	40.00	10.57	39.88	10.77	37.50	9.97	36.31	9.58	35.12	9.20	32.74	8.44
	5(41)	4.1(39.4)	42.02	10.77	39.88	10.11	37.50	9.37	36.31	9.01	35.12	8.66	32.74	7.96
	7(44.6)	6(42.8)	42.26	10.22	39.88	9.51	37.50	8.82	36.31	8.49	35.12	8.16	32.74	7.50
9(48.2)	7.9(46.2)	42.26	9.60	39.88	8.95	37.50	8.30	36.31	7.89	35.12	7.69	32.74	7.08	
11(51.8)	9.8(49.6)	42.26	9.04	39.88	8.43	37.50	7.83	36.31	7.54	35.12	7.25	32.74	6.69	
13(55.4)	11.8(53.2)	42.26	8.49	39.88	7.93	37.50	7.38	36.31	7.10	35.12	6.84	32.74	6.31	
15(59)	13.7(56.7)	42.26	8.01	39.88	7.48	37.50	6.96	36.31	6.71	35.12	6.46	32.74	5.98	
90%	-19.8(-3.6)	-20(-4)	23.77	8.61	23.65	8.91	23.65	9.22	23.53	9.37	23.53	9.53	23.53	9.83
	-18.8(-1.8)	-19(-2.2)	24.12	8.70	24.12	9.01	24.01	9.31	24.01	9.46	24.01	9.61	23.88	9.91
	-16.7(1.9)	-17(1.4)	25.08	8.92	24.95	9.21	24.95	9.50	24.95	9.64	24.84	9.78	24.84	10.07
	-13.7(7.3)	-15(5)	26.14	9.14	26.02	9.42	26.02	9.69	25.91	9.83	25.91	9.97	25.91	10.24
	-11.8(10.8)	-13(8.6)	27.21	9.36	27.21	9.62	27.09	9.88	27.09	10.02	27.09	10.15	26.98	10.41
	-9.8(14.4)	-11(12.2)	28.52	9.58	28.52	9.83	28.40	10.08	28.40	10.21	28.40	10.34	28.28	10.60
	-9.5(14.9)	-10(14)	29.23	9.69	29.12	9.94	29.12	10.18	29.00	10.31	29.00	10.43	29.00	10.68
	-8.5(16.7)	-9.1(15.6)	29.83	9.79	29.83	10.03	29.71	10.27	29.71	10.39	29.71	10.52	29.35	10.62
	-7(19.4)	-7.6(18.3)	30.90	9.95	30.90	10.18	30.78	10.42	30.78	10.54	30.78	10.65	29.35	10.14
	-5(23)	-5.6(21.9)	32.56	10.17	32.44	10.39	32.44	10.61	32.32	10.72	31.49	10.39	29.35	9.53
	-3(26.6)	-3.7(25.3)	34.11	10.37	34.11	10.57	33.75	10.62	32.56	10.19	31.49	9.78	29.35	8.98
	0(32)	-0.7(30.7)	36.96	10.66	35.89	10.40	33.75	9.63	32.56	9.25	31.49	8.89	29.35	8.17
	3(37.4)	2.2(36)	38.03	10.16	35.89	9.46	33.75	8.77	32.56	8.44	31.49	8.11	29.35	7.47
	5(41)	4.1(39.4)	38.03	9.55	35.89	8.90	33.75	8.27	32.56	7.95	31.49	7.65	29.35	7.04
	7(44.6)	6(42.8)	38.03	8.98	35.89	8.38	33.75	7.79	32.56	7.50	31.49	7.22	29.35	6.65
9(48.2)	7.9(46.2)	38.03	8.47	35.89	7.89	33.75	7.34	32.56	7.08	31.49	6.82	29.35	6.29	
11(51.8)	9.8(49.6)	38.03	7.97	35.89	7.45	33.75	6.94	32.56	6.69	31.49	6.44	29.35	5.96	
13(55.4)	11.8(53.2)	38.03	7.50	35.89	7.02	33.75	6.54	32.56	6.31	31.49	6.08	29.35	5.62	
15(59)	13.7(56.7)	38.03	7.09	35.89	6.63	33.75	6.20	32.56	5.98	31.49	5.76	29.35	5.34	
80%	-19.8(-3.6)	-20(-4)	23.69	9.21	23.57	9.47	23.57	9.75	23.57	9.89	23.45	10.02	23.45	10.29
	-18.8(-1.8)	-19(-2.2)	24.05	9.29	24.05	9.56	23.93	9.83	23.93	9.96	23.93	10.09	23.81	10.37
	-16.7(1.9)	-17(1.4)	25.00	9.48	24.88	9.74	24.88	10.00	24.88	10.13	24.88	10.25	24.76	10.50
	-13.7(7.3)	-15(5)	26.07	9.68	25.95	9.92	25.95	10.17	25.95	10.29	25.83	10.41	25.83	10.66
	-11.8(10.8)	-13(8.6)	27.14	9.87	27.14	10.11	27.02	10.34	27.02	10.46	27.02	10.58	26.19	10.30
	-9.8(14.4)	-11(12.2)	28.45	10.07	28.45	10.30	28.33	10.53	28.33	10.63	28.10	10.61	26.19	9.72
	-9.5(14.9)	-10(14)	29.17	10.17	29.04	10.39	29.05	10.61	29.05	10.72	28.10	10.30	26.19	9.44
	-8.5(16.7)	-9.1(15.6)	29.76	10.26	27.66	10.48	29.64	10.69	29.05	10.45	28.10	10.02	26.19	9.19
	-7(19.4)	-7.6(18.3)	30.83	10.41	30.83	10.62	30.00	10.39	29.05	9.98	28.10	9.58	26.19	8.78
	-5(23)	-5.6(21.9)	32.50	10.59	31.91	10.54	30.00	9.76	29.05	9.38	28.10	9.00	26.19	8.27
	-3(26.6)	-3.7(25.3)	33.81	10.65	31.91	9.92	30.00	9.19	29.05	8.84	28.10	8.49	26.19	7.81
	0(32)	-0.7(30.7)	33.81	9.67	31.91	9.00	30.00	8.36	29.05	8.05	28.10	7.73	26.19	7.12
	3(37.4)	2.2(36)	33.81	8.81	31.91	8.21	30.00	7.64	29.05	7.35	28.10	7.08	26.19	6.53
	5(41)	4.1(39.4)	33.81	8.29	31.91	7.74	30.00	7.20	29.05	6.94	28.10	6.69	26.19	6.17
	7(44.6)	6(42.8)	33.81	7.81	31.91	7.31	30.00	6.80	29.05	6.56	28.10	6.32	26.19	5.84
9(48.2)	7.9(46.2)	33.81	7.38	31.91	6.90	30.00	6.43	29.05	6.20	28.10	5.98	26.19	5.53	
11(51.8)	9.8(49.6)	33.81	6.96	31.91	6.52	30.00	6.08	29.05	5.86	28.10	5.66	26.19	5.25	
13(55.4)	11.8(53.2)	33.81	6.56	31.91	6.15	30.00	5.75	29.05	5.54	28.10	5.35	26.19	4.96	
15(59)	13.7(56.7)	33.81	6.21	31.91	5.83	30.00	5.45	29.05	5.26	28.10	5.07	26.19	4.72	

**Heating capacity tables**

**MVD-V5X335W/V2GN1**

TC: Total Capacity (kW); PI: Power Input (kW) (Compressor + Outdoor fan motor)

Combination (%)	Outdoor temperature		Indoor temperature(°C(°F) DB)											
			16(60.8)		18(64.4)		20(68)		21(69.8)		22(71.6)		24(75.2)	
	°C(°F) DB	°C(°F) WB	TC	PI	TC	PI	TC	PI	TC	PI	TC	PI	TC	PI
70%	-19.8(-3.6)	-20(-4)	23.52	9.80	23.40	10.03	23.40	10.27	23.40	10.39	23.40	10.51	22.81	10.40
	-18.8(-1.8)	-19(-2.2)	23.87	9.88	23.87	10.11	23.76	10.34	23.76	10.46	23.76	10.58	22.81	10.18
	-16.7(1.9)	-17(1.4)	24.82	10.05	24.82	10.27	24.71	10.49	24.71	10.61	24.47	9.45	22.81	9.71
	-13.7(7.3)	-15(5)	25.89	10.22	25.77	10.43	25.77	10.65	25.30	10.49	24.47	10.07	22.81	9.23
	-11.8(10.8)	-13(8.6)	26.96	10.39	26.96	10.59	26.25	10.34	25.30	9.94	24.47	9.54	22.81	8.75
	-9.8(14.4)	-11(12.2)	28.27	10.56	27.91	10.55	26.25	9.77	25.30	9.39	24.47	9.01	22.81	8.28
	-9.5(14.9)	-10(14)	28.98	10.65	27.91	10.24	26.25	9.48	25.30	9.12	24.47	8.76	22.81	8.05
	-8.5(16.7)	-9.1(15.6)	29.58	10.71	27.91	9.96	26.25	9.23	25.30	8.88	24.47	8.53	22.81	7.85
	-7(19.4)	-7.6(18.3)	29.58	10.23	27.91	9.52	26.25	8.83	25.30	8.50	24.47	8.17	22.81	7.51
	-5(23)	-5.6(21.9)	29.58	9.61	27.91	8.96	26.25	8.32	25.30	7.99	24.47	7.44	22.81	7.09
	-3(26.6)	-3.7(25.3)	29.58	9.05	27.91	8.44	26.25	7.85	25.30	7.55	24.47	7.26	22.81	6.70
	0(32)	-0.7(30.7)	29.58	8.24	27.91	7.70	26.25	7.16	25.30	6.90	24.47	6.64	22.81	6.14
	3(37.4)	2.2(36)	29.58	7.53	27.91	7.04	26.25	6.56	25.30	6.32	24.47	6.09	22.81	5.64
	5(41)	4.1(39.4)	29.58	7.10	27.91	6.64	26.25	6.21	25.30	5.98	24.47	5.76	22.81	5.34
	7(44.6)	6(42.8)	29.58	6.71	27.91	6.29	26.25	5.86	25.30	5.66	24.47	5.46	22.81	5.06
9(48.2)	7.9(46.2)	29.58	6.35	27.91	5.94	26.25	5.56	25.30	5.36	24.47	5.18	22.81	4.80	
11(51.8)	9.8(49.6)	29.58	6.00	27.91	5.62	26.25	5.27	25.30	5.09	24.47	4.91	22.81	4.56	
13(55.4)	11.8(53.2)	29.58	5.67	27.91	5.33	26.25	4.98	25.30	4.82	24.47	4.65	22.81	4.33	
15(59)	13.7(56.7)	29.58	5.37	27.91	5.05	26.25	4.73	25.30	4.58	24.47	4.42	22.81	4.12	
60%	-19.8(-3.6)	-20(-4)	23.45	10.40	23.33	10.59	22.50	10.19	21.79	9.79	21.07	9.40	19.64	8.62
	-18.8(-1.8)	-19(-2.2)	23.81	10.47	23.81	10.66	22.50	9.98	21.79	9.59	21.07	9.20	19.64	8.44
	-16.7(1.9)	-17(1.4)	24.76	10.61	23.93	10.27	22.50	9.52	21.79	9.15	21.07	8.79	19.64	8.07
	-13.7(7.3)	-15(5)	25.36	10.49	23.93	9.76	22.50	9.05	21.79	8.71	21.07	8.36	19.64	7.69
	-11.8(10.8)	-13(8.6)	25.36	9.93	23.93	9.24	22.50	8.58	21.79	8.26	21.07	7.94	19.64	7.34
	-9.8(14.4)	-11(12.2)	25.36	9.38	23.93	8.74	22.50	8.12	21.79	7.81	21.07	7.51	19.64	6.93
	-9.5(14.9)	-10(14)	25.36	9.12	23.93	8.50	22.50	7.89	21.79	7.61	21.07	7.31	19.64	6.73
	-8.5(16.7)	-9.1(15.6)	25.36	8.88	23.93	8.28	22.50	7.70	21.79	7.41	21.07	7.12	19.64	6.57
	-7(19.4)	-7.6(18.3)	25.36	8.49	23.93	7.93	22.50	7.36	21.79	7.10	21.07	6.83	19.64	6.31
	-5(23)	-5.6(21.9)	25.36	7.99	23.93	7.47	22.50	6.95	21.79	6.70	21.07	6.45	19.64	5.97
	-3(26.6)	-3.7(25.3)	25.36	7.55	23.93	7.06	22.50	6.57	21.79	6.35	21.07	6.10	19.64	5.65
	0(32)	-0.7(30.7)	25.36	6.90	23.93	6.46	22.50	6.02	21.79	5.82	21.07	5.60	19.64	5.19
	3(37.4)	2.2(36)	25.36	6.32	23.93	5.93	22.50	5.54	21.79	5.35	21.07	5.17	19.64	4.79
	5(41)	4.1(39.4)	25.36	5.98	23.93	5.61	22.50	5.25	21.79	5.07	21.07	4.89	19.64	4.55
	7(44.6)	6(42.8)	25.36	5.66	23.93	5.31	22.50	4.97	21.79	4.81	21.07	4.65	19.64	4.32
9(48.2)	7.9(46.2)	25.36	5.36	23.93	5.04	22.50	4.72	21.79	4.57	21.07	4.41	19.64	4.11	
11(51.8)	9.8(49.6)	25.36	5.09	23.93	4.79	22.50	4.49	21.79	4.34	21.07	4.19	19.64	3.92	
13(55.4)	11.8(53.2)	25.36	4.81	23.93	4.54	22.50	4.26	21.79	4.12	21.07	3.99	19.64	3.72	
15(59)	13.7(56.7)	25.36	4.58	23.93	4.31	22.50	4.05	21.79	3.93	21.07	3.80	19.64	3.55	
50%	-19.8(-3.6)	-20(-4)	21.12	9.46	19.94	8.81	18.75	8.18	18.04	7.88	17.45	7.57	16.26	6.98
	-18.8(-1.8)	-19(-2.2)	21.12	9.25	19.94	8.62	18.75	8.02	18.04	7.71	17.45	7.41	16.26	6.84
	-16.7(1.9)	-17(1.4)	21.12	8.83	19.94	8.24	18.75	7.66	18.04	7.38	17.45	7.10	16.26	6.55
	-13.7(7.3)	-15(5)	21.12	8.41	19.94	7.85	18.75	7.30	18.04	7.03	17.45	6.77	16.26	6.25
	-11.8(10.8)	-13(8.6)	21.12	7.98	19.94	7.46	18.75	6.94	18.04	6.69	17.45	6.44	16.26	5.96
	-9.8(14.4)	-11(12.2)	21.12	7.56	19.94	7.07	18.75	6.59	18.04	6.35	17.45	6.12	16.26	5.66
	-9.5(14.9)	-10(14)	21.12	7.35	19.94	6.87	18.75	6.41	18.04	6.18	17.45	5.96	16.26	5.51
	-8.5(16.7)	-9.1(15.6)	21.12	7.17	19.94	6.71	18.75	6.25	18.04	6.04	17.45	5.82	16.26	5.38
	-7(19.4)	-7.6(18.3)	21.12	6.87	19.94	6.44	18.75	6.00	18.04	5.80	17.45	5.59	16.26	5.18
	-5(23)	-5.6(21.9)	21.12	6.48	19.94	6.08	18.75	5.68	18.04	5.49	17.45	5.29	16.26	4.90
	-3(26.6)	-3.7(25.3)	21.12	6.14	19.94	5.76	18.75	5.38	18.04	5.20	17.45	5.02	16.26	4.66
	0(32)	-0.7(30.7)	21.12	5.64	19.94	5.29	18.75	4.96	18.04	4.79	17.45	4.63	16.26	4.31
	3(37.4)	2.2(36)	21.12	5.19	19.94	4.88	18.75	4.57	18.04	4.42	17.45	4.27	16.26	3.99
	5(41)	4.1(39.4)	21.12	4.92	19.94	4.63	18.75	4.34	18.04	4.20	17.45	4.07	16.26	3.79
	7(44.6)	6(42.8)	21.12	4.67	19.94	4.40	18.75	4.13	18.04	4.00	17.45	3.87	16.26	3.62
9(48.2)	7.9(46.2)	21.12	4.43	19.94	4.18	18.75	3.93	18.04	3.81	17.45	3.69	16.26	3.45	
11(51.8)	9.8(49.6)	21.12	4.22	19.94	3.97	18.75	3.75	18.04	3.63	17.45	3.52	16.26	3.29	
13(55.4)	11.8(53.2)	21.12	4.01	19.94	3.78	18.75	3.56	18.04	3.46	17.45	3.34	16.26	3.14	
15(59)	13.7(56.7)	21.12	3.81	19.94	3.61	18.75	3.40	18.04	3.30	17.45	3.20	16.26	3.00	

**Heating capacity tables**

**MVD-V5X400W/V2GN1**

TC: Total Capacity (kW); PI: Power Input (kW) (Compressor + Outdoor fan motor)

Combination (%)	Outdoor temperature		Indoor temperature(°C(°F) DB)											
			16(60.8)		18(64.4)		20(68)		21(69.8)		22(71.6)		24(75.2)	
	°C(°F) DB	°C(°F) WB	TC	PI	TC	PI	TC	PI	TC	PI	TC	PI	TC	PI
130%	-19.8(-3.6)	-20(-4)	29.14	7.96	29.00	8.52	28.86	9.09	28.86	9.37	28.72	9.64	28.72	10.21
	-18.8(-1.8)	-19(-2.2)	29.57	8.14	29.43	8.69	29.43	9.25	29.29	9.53	29.29	9.79	29.14	10.35
	-16.7(1.9)	-17(1.4)	30.71	8.52	30.57	9.04	30.43	9.59	30.43	9.85	30.43	10.11	30.29	10.64
	-13.7(7.3)	-15(5)	32.00	8.91	31.86	9.43	31.71	9.94	31.71	10.19	31.57	10.45	31.57	10.96
	-11.8(10.8)	-13(8.6)	33.29	9.31	33.29	9.80	33.14	10.29	33.00	10.54	33.00	10.79	32.86	11.27
	-9.8(14.4)	-11(12.2)	34.86	9.72	34.71	10.19	34.57	10.65	34.57	10.89	34.57	11.12	34.43	11.59
	-9.5(14.9)	-10(14)	35.71	9.92	35.57	10.38	35.43	10.83	35.43	11.06	35.28	11.28	35.28	11.74
	-8.5(16.7)	-9.1(15.6)	36.43	10.10	36.29	10.54	36.29	10.99	36.14	11.21	36.14	11.43	36.00	11.88
	-7(19.4)	-7.6(18.3)	37.71	10.39	37.71	10.83	37.57	11.25	37.57	11.47	37.43	11.68	37.28	12.12
	-5(23)	-5.6(21.9)	39.71	10.79	39.57	11.20	39.43	11.61	39.43	11.81	39.29	12.00	39.29	12.41
	-3(26.6)	-3.7(25.3)	41.57	11.14	41.43	11.53	41.43	11.91	41.28	12.12	41.28	12.31	41.14	12.69
	0(32)	-0.7(30.7)	44.85	11.68	44.85	12.04	44.71	12.40	44.71	12.53	44.57	12.76	44.57	13.11
	3(37.4)	2.2(36)	48.42	12.16	48.29	12.50	48.14	12.84	48.14	13.00	48.14	13.17	48.00	13.49
	5(41)	4.1(39.4)	50.85	12.47	50.71	12.79	50.71	13.10	50.57	13.26	50.57	13.42	50.43	13.73
	7(44.6)	6(42.8)	53.43	12.76	53.28	13.05	53.28	13.36	53.14	13.51	53.14	13.65	51.00	13.11
9(48.2)	7.9(46.2)	56.14	13.02	56.00	13.32	56.00	13.60	55.86	13.74	54.71	13.45	51.00	12.32	
11(51.8)	9.8(49.6)	59.00	13.29	58.86	13.55	58.57	13.73	56.57	13.19	54.71	12.64	51.00	11.61	
13(55.4)	11.8(53.2)	62.14	13.54	62.00	13.80	58.57	12.86	56.57	12.35	54.71	11.87	51.00	10.89	
15(59)	13.7(56.7)	65.14	13.77	62.28	13.07	58.57	12.12	56.57	11.65	54.71	11.18	51.00	10.27	
120%	-19.8(-3.6)	-20(-4)	29.00	8.28	28.86	8.77	28.71	9.27	28.71	9.50	28.71	9.75	28.57	10.25
	-18.8(-1.8)	-19(-2.2)	29.43	8.43	29.29	8.92	29.29	9.41	29.14	9.64	29.14	9.89	29.00	10.38
	-16.7(1.9)	-17(1.4)	30.57	8.77	30.43	9.24	30.24	9.70	30.29	9.93	30.29	10.17	30.14	10.63
	-13.7(7.3)	-15(5)	31.86	9.11	31.72	9.56	31.57	10.00	31.57	10.24	31.57	10.46	31.43	10.91
	-11.8(10.8)	-13(8.6)	33.15	9.46	33.15	9.89	33.00	10.32	33.00	10.55	32.86	10.75	32.86	11.18
	-9.8(14.4)	-11(12.2)	34.71	9.82	34.57	10.23	34.57	10.64	34.43	10.85	34.43	11.05	34.29	11.46
	-9.5(14.9)	-10(14)	35.58	10.00	35.43	10.41	35.29	10.80	35.29	11.00	35.29	11.20	35.14	11.60
	-8.5(16.7)	-9.1(15.6)	36.29	10.16	36.14	10.55	36.14	10.93	36.00	11.13	36.00	11.34	35.86	11.73
	-7(19.4)	-7.6(18.3)	37.57	10.42	37.57	10.80	37.43	11.17	37.43	11.37	37.29	11.55	37.29	11.92
	-5(23)	-5.6(21.9)	39.57	10.75	39.43	11.12	39.28	11.48	39.28	11.66	39.28	11.84	39.15	12.19
	-3(26.6)	-3.7(25.3)	41.43	11.07	41.43	11.42	41.29	11.75	41.29	11.92	41.14	12.10	41.14	12.44
	0(32)	-0.7(30.7)	44.72	11.55	44.72	11.87	44.57	12.17	44.57	12.34	44.43	12.49	44.43	12.81
	3(37.4)	2.2(36)	48.29	11.98	48.14	12.27	48.14	12.56	48.00	12.71	48.00	12.85	47.00	12.78
	5(41)	4.1(39.4)	50.72	12.24	50.57	12.52	50.57	12.80	50.43	12.94	50.43	13.07	47.00	12.00
	7(44.6)	6(42.8)	53.29	12.49	53.29	12.75	53.15	13.02	52.29	12.84	50.57	12.31	47.00	11.30
9(48.2)	7.9(46.2)	56.00	12.74	55.86	12.99	54.00	12.56	52.29	12.06	50.57	11.57	47.00	10.63	
11(51.8)	9.8(49.6)	58.86	12.96	57.43	12.74	54.00	11.81	52.29	11.35	50.57	10.89	47.00	10.02	
13(55.4)	11.8(53.2)	61.00	12.84	57.43	11.95	54.00	11.07	52.29	10.66	50.57	10.24	47.00	9.42	
15(59)	13.7(56.7)	61.00	12.09	57.43	11.25	54.00	10.45	52.29	10.05	50.57	9.66	47.00	8.89	
110%	-19.8(-3.6)	-20(-4)	28.86	9.24	28.72	9.70	28.57	10.17	28.57	10.40	28.58	10.62	28.43	11.09
	-18.8(-1.8)	-19(-2.2)	29.29	9.38	29.14	9.84	29.14	10.30	29.14	10.52	29.00	10.75	29.00	11.21
	-16.7(1.9)	-17(1.4)	30.43	9.70	30.29	10.14	30.71	10.58	30.14	10.80	30.14	11.02	30.00	11.45
	-13.7(7.3)	-15(5)	31.72	10.03	31.58	10.45	31.43	10.87	31.43	11.08	31.43	11.29	31.28	11.71
	-11.8(10.8)	-13(8.6)	33.00	10.37	33.00	10.77	32.86	11.17	32.86	11.37	32.71	11.57	32.71	11.98
	-9.8(14.4)	-11(12.2)	34.57	10.70	34.43	11.08	34.43	11.47	34.28	11.67	34.28	11.85	34.28	12.24
	-9.5(14.9)	-10(14)	35.43	10.87	35.29	11.24	35.14	11.62	35.14	11.81	35.14	11.99	35.00	12.36
	-8.5(16.7)	-9.1(15.6)	36.14	11.01	36.00	11.38	36.00	11.75	35.86	11.94	35.86	12.12	35.86	11.05
	-7(19.4)	-7.6(18.3)	37.43	11.27	37.43	11.61	37.29	11.96	37.29	12.15	37.29	12.32	37.14	12.68
	-5(23)	-5.6(21.9)	39.43	11.58	39.29	11.92	39.14	12.25	39.14	12.42	39.14	12.59	39.00	12.94
	-3(26.6)	-3.7(25.3)	41.29	11.88	41.29	12.19	41.14	12.52	41.14	12.68	41.00	12.83	41.00	13.16
	0(32)	-0.7(30.7)	44.57	12.32	44.57	12.62	44.43	12.92	44.43	13.06	44.43	13.22	43.14	12.96
	3(37.4)	2.2(36)	48.14	12.73	48.00	13.01	48.00	13.28	47.86	13.40	46.29	12.86	43.14	11.79
	5(41)	4.1(39.4)	50.57	12.98	50.57	13.25	49.57	13.12	47.86	12.59	46.29	12.09	43.14	11.09
	7(44.6)	6(42.8)	53.14	13.22	52.71	13.31	49.57	12.32	47.86	11.84	46.29	11.37	43.14	10.44
9(48.2)	7.9(46.2)	55.86	13.43	52.71	12.51	49.57	11.59	47.86	11.14	46.29	10.70	43.14	9.84	
11(51.8)	9.8(49.6)	55.86	12.63	52.71	11.76	49.57	10.91	47.86	10.50	46.29	10.08	43.14	9.28	
13(55.4)	11.8(53.2)	55.86	11.85	52.71	11.04	49.57	10.25	47.86	9.87	46.29	9.48	43.14	8.74	
15(59)	13.7(56.7)	55.86	10.52	52.71	10.41	49.57	9.68	47.86	9.31	46.29	8.97	43.14	8.27	

**Heating capacity tables**

**MVD-V5X400W/V2GN1**

TC: Total Capacity (kW); PI: Power Input (kW) (Compressor + Outdoor fan motor)

Combination (%)	Outdoor temperature		Indoor temperature(°C(°F) DB)											
			16(60.8)		18(64.4)		20(68)		21(69.8)		22(71.6)		24(75.2)	
	°C(°F) DB	°C(°F) WB	TC	PI	TC	PI	TC	PI	TC	PI	TC	PI	TC	PI
100%	-19.8(-3.6)	-20(-4)	28.71	9.98	28.57	10.40	28.57	10.82	28.43	11.04	28.43	11.24	28.29	11.66
	-18.8(-1.8)	-19(-2.2)	29.14	10.11	29.14	10.52	29.00	10.94	29.00	11.15	28.86	11.37	28.86	11.78
	-16.7(1.9)	-17(1.4)	30.29	10.40	30.14	10.79	30.14	11.19	30.00	11.39	30.00	11.59	30.00	11.99
	-13.7(7.3)	-15(5)	31.57	10.69	31.43	11.08	31.28	11.47	31.28	11.66	31.28	11.85	31.14	12.23
	-11.8(10.8)	-13(8.6)	32.86	11.01	32.86	11.37	32.72	11.74	32.72	11.92	32.72	12.11	32.57	12.48
	-9.8(14.4)	-11(12.2)	34.43	11.31	34.29	11.66	34.29	12.01	34.29	12.19	34.14	12.36	34.14	12.70
	-9.5(14.9)	-10(14)	35.28	11.47	35.15	11.81	35.15	12.15	35.00	12.32	35.00	12.49	34.86	12.83
	-8.5(16.7)	-9.1(15.6)	36.00	11.59	35.86	11.94	35.86	12.26	35.86	12.43	35.72	12.61	35.72	12.93
	-7(19.4)	-7.6(18.3)	37.29	11.82	37.29	12.15	37.14	12.46	37.14	12.63	37.14	12.79	37.00	13.12
	-5(23)	-5.6(21.9)	39.29	12.12	39.14	12.42	39.14	12.73	39.00	12.88	39.00	13.03	38.86	13.35
	-3(26.6)	-3.7(25.3)	41.14	12.39	41.14	11.25	41.00	12.98	41.00	13.12	41.00	13.26	39.29	12.70
	0(32)	-0.7(30.7)	44.43	12.79	44.43	13.06	44.28	13.33	43.57	13.12	42.14	12.58	39.29	11.54
	3(37.4)	2.2(36)	48.00	13.16	47.86	13.40	45.00	12.41	43.57	11.92	42.14	11.45	39.29	10.51
	5(41)	4.1(39.4)	50.43	13.40	47.86	12.59	45.00	11.66	43.57	11.22	42.14	10.78	39.29	9.91
	7(44.6)	6(42.8)	50.72	12.72	47.86	11.84	45.00	10.98	43.57	10.57	42.14	10.15	39.29	9.34
9(48.2)	7.9(46.2)	50.72	11.95	47.86	11.14	45.00	10.34	43.57	9.82	42.14	9.57	39.29	8.81	
11(51.8)	9.8(49.6)	50.72	11.25	47.86	10.49	45.00	9.75	43.57	9.38	42.14	9.03	39.29	8.33	
13(55.4)	11.8(53.2)	50.72	10.57	47.86	9.87	45.00	9.18	43.57	8.84	42.14	8.51	39.29	7.86	
15(59)	13.7(56.7)	50.72	9.97	47.86	9.31	45.00	8.67	43.57	8.36	42.14	8.04	39.29	7.44	
90%	-19.8(-3.6)	-20(-4)	28.52	10.72	28.38	11.09	28.38	11.48	28.24	11.66	28.24	11.86	28.24	12.23
	-18.8(-1.8)	-19(-2.2)	28.95	10.84	28.95	11.22	28.81	11.59	28.81	11.78	28.81	11.96	28.66	12.33
	-16.7(1.9)	-17(1.4)	30.09	11.11	29.95	11.47	29.95	11.82	29.95	12.01	29.80	12.18	29.80	12.53
	-13.7(7.3)	-15(5)	31.37	11.38	31.23	11.72	31.23	12.06	31.09	12.23	31.09	12.41	31.09	12.75
	-11.8(10.8)	-13(8.6)	32.66	11.65	32.66	11.98	32.51	12.31	32.51	12.48	32.51	12.63	32.37	12.96
	-9.8(14.4)	-11(12.2)	34.23	11.92	34.23	12.23	34.08	12.55	34.08	12.71	34.08	12.88	33.94	13.19
	-9.5(14.9)	-10(14)	35.08	12.06	34.94	12.38	34.94	12.68	34.80	12.83	34.80	12.99	34.80	13.29
	-8.5(16.7)	-9.1(15.6)	35.79	12.19	35.79	12.49	35.65	12.79	35.65	12.93	35.65	13.09	35.22	13.22
	-7(19.4)	-7.6(18.3)	37.08	12.39	37.08	12.68	36.94	12.98	36.94	13.12	36.94	13.26	35.22	12.62
	-5(23)	-5.6(21.9)	39.07	12.66	38.93	12.93	38.93	13.20	38.79	13.35	37.79	12.93	35.22	11.86
	-3(26.6)	-3.7(25.3)	40.93	12.90	40.93	13.16	40.50	13.22	39.07	12.69	37.79	12.18	35.22	11.18
	0(32)	-0.7(30.7)	44.35	13.28	43.07	12.95	40.50	11.99	39.07	11.52	37.79	11.07	35.22	10.17
	3(37.4)	2.2(36)	45.64	12.65	43.07	11.78	40.50	10.92	39.07	10.51	37.79	10.10	35.22	9.30
	5(41)	4.1(39.4)	45.64	11.89	43.07	11.08	40.50	10.30	39.07	9.90	37.79	9.53	35.22	8.77
	7(44.6)	6(42.8)	45.64	11.18	43.07	10.44	40.50	9.70	39.07	9.34	37.79	8.98	35.22	8.28
9(48.2)	7.9(46.2)	45.64	10.54	43.07	9.82	40.50	9.14	39.07	8.81	37.79	8.48	35.22	7.83	
11(51.8)	9.8(49.6)	45.64	9.92	43.07	9.27	40.50	8.64	39.07	8.33	37.79	8.01	35.22	7.41	
13(55.4)	11.8(53.2)	45.64	9.34	43.07	8.74	40.50	8.14	39.07	7.86	37.79	7.57	35.22	7.00	
15(59)	13.7(56.7)	45.64	8.83	43.07	8.26	40.50	7.71	39.07	7.44	37.79	7.17	35.22	6.64	
80%	-19.8(-3.6)	-20(-4)	28.43	11.46	28.29	11.79	28.29	12.13	28.29	12.31	28.14	12.48	28.14	12.80
	-18.8(-1.8)	-19(-2.2)	28.86	11.56	28.86	11.91	28.71	12.23	28.71	12.41	28.71	12.56	28.57	12.90
	-16.7(1.9)	-17(1.4)	30.00	11.81	29.86	12.12	29.86	12.45	29.86	12.61	29.86	12.76	29.71	13.08
	-13.7(7.3)	-15(5)	31.28	12.05	31.14	12.35	31.14	12.66	31.14	12.80	31.00	12.96	31.00	13.27
	-11.8(10.8)	-13(8.6)	32.57	12.29	32.57	12.59	32.43	12.88	32.43	13.02	32.43	13.18	31.43	12.82
	-9.8(14.4)	-11(12.2)	34.14	12.53	34.14	12.82	34.00	13.10	34.00	13.23	33.71	13.20	31.43	12.11
	-9.5(14.9)	-10(14)	35.00	12.66	34.85	12.93	34.86	13.20	34.86	13.35	33.71	12.82	31.43	11.75
	-8.5(16.7)	-9.1(15.6)	35.72	12.78	33.20	13.05	35.57	13.30	34.86	13.00	33.71	12.48	31.43	11.44
	-7(19.4)	-7.6(18.3)	37.00	12.96	37.00	13.22	36.00	12.93	34.86	12.42	33.71	11.92	31.43	10.94
	-5(23)	-5.6(21.9)	39.00	13.19	38.29	13.12	36.00	12.15	34.86	11.68	33.71	11.21	31.43	10.30
	-3(26.6)	-3.7(25.3)	40.57	13.26	38.29	12.35	36.00	11.44	34.86	11.01	33.71	10.57	31.43	9.72
	0(32)	-0.7(30.7)	40.57	12.03	38.29	11.21	36.00	10.41	34.86	10.02	33.71	9.63	31.43	8.87
	3(37.4)	2.2(36)	40.57	10.97	38.29	10.22	36.00	9.51	34.86	9.15	33.71	8.81	31.43	8.13
	5(41)	4.1(39.4)	40.57	10.32	38.29	9.64	36.00	8.97	34.86	8.64	33.71	8.33	31.43	7.69
	7(44.6)	6(42.8)	40.57	9.72	38.29	9.10	36.00	8.47	34.86	8.17	33.71	7.87	31.43	7.27
9(48.2)	7.9(46.2)	40.57	9.18	38.29	8.58	36.00	8.00	34.86	7.71	33.71	7.44	31.43	6.89	
11(51.8)	9.8(49.6)	40.57	8.67	38.29	8.11	36.00	7.57	34.86	7.30	33.71	7.04	31.43	6.53	
13(55.4)	11.8(53.2)	40.57	8.17	38.29	7.66	36.00	7.16	34.86	6.90	33.71	6.66	31.43	6.17	
15(59)	13.7(56.7)	40.57	7.73	38.29	7.26	36.00	6.79	34.86	6.54	33.71	6.32	31.43	5.87	



**Heating capacity tables**

**MVD-V5X400W/V2GN1**

TC: Total Capacity (kW); PI: Power Input (kW) (Compressor + Outdoor fan motor)

Combination (%)	Outdoor temperature		Indoor temperature(°C(°F) DB)											
			16(60.8)		18(64.4)		20(68)		21(69.8)		22(71.6)		24(75.2)	
	°C(°F) DB	°C(°F) WB	TC	PI	TC	PI	TC	PI	TC	PI	TC	PI	TC	PI
70%	-19.8(-3.6)	-20(-4)	28.22	12.21	28.08	12.49	28.08	12.79	28.08	12.93	28.08	13.09	27.37	12.95
	-18.8(-1.8)	-19(-2.2)	28.65	12.31	28.65	12.59	28.51	12.88	28.51	13.02	28.51	13.18	27.37	12.68
	-16.7(1.9)	-17(1.4)	29.79	12.51	29.79	12.79	29.65	13.06	29.65	13.20	29.36	11.76	27.37	12.09
	-13.7(7.3)	-15(5)	31.07	12.72	30.93	12.99	30.93	13.26	30.36	13.06	29.36	12.53	27.37	11.49
	-11.8(10.8)	-13(8.6)	32.35	12.93	32.35	13.19	31.50	12.88	30.36	12.38	29.36	11.88	27.37	10.89
	-9.8(14.4)	-11(12.2)	33.92	13.15	33.49	13.13	31.50	12.16	30.36	11.69	29.36	11.22	27.37	10.31
	-9.5(14.9)	-10(14)	34.78	13.26	33.49	12.75	31.50	11.81	30.36	11.35	29.36	10.91	27.37	10.02
	-8.5(16.7)	-9.1(15.6)	35.49	13.33	33.49	12.41	31.50	11.49	30.36	11.05	29.36	10.62	27.37	9.77
	-7(19.4)	-7.6(18.3)	35.49	12.73	33.49	11.85	31.50	10.99	30.36	10.58	29.36	10.17	27.37	9.35
	-5(23)	-5.6(21.9)	35.49	11.96	33.49	11.15	31.50	10.35	30.36	9.95	29.36	11.76	27.37	8.83
	-3(26.6)	-3.7(25.3)	35.49	11.26	33.49	10.51	31.50	9.77	30.36	9.40	29.36	9.04	27.37	8.34
	0(32)	-0.7(30.7)	35.49	10.25	33.49	9.58	31.50	8.91	30.36	8.58	29.36	8.27	27.37	7.64
	3(37.4)	2.2(36)	35.49	9.37	33.49	8.77	31.50	8.17	30.36	7.87	29.36	7.59	27.37	7.02
	5(41)	4.1(39.4)	35.49	8.84	33.49	8.27	31.50	7.73	30.36	7.44	29.36	7.17	27.37	6.65
	7(44.6)	6(42.8)	35.49	8.36	33.49	7.83	31.50	7.30	30.36	7.04	29.36	6.80	27.37	6.30
9(48.2)	7.9(46.2)	35.49	7.90	33.49	7.40	31.50	6.92	30.36	6.67	29.36	6.44	27.37	5.97	
11(51.8)	9.8(49.6)	35.49	7.47	33.49	7.00	31.50	6.56	30.36	6.33	29.36	6.12	27.37	5.67	
13(55.4)	11.8(53.2)	35.49	7.06	33.49	6.63	31.50	6.20	30.36	6.00	29.36	5.79	27.37	5.39	
15(59)	13.7(56.7)	35.49	6.69	33.49	6.29	31.50	5.89	30.36	5.70	29.36	5.50	27.37	5.13	
60%	-19.8(-3.6)	-20(-4)	28.14	12.95	28.00	13.19	27.00	12.69	26.14	12.19	25.29	11.71	23.57	10.74
	-18.8(-1.8)	-19(-2.2)	28.57	13.03	28.57	13.28	27.00	12.42	26.14	11.93	25.29	11.45	23.57	10.51
	-16.7(1.9)	-17(1.4)	29.71	13.20	28.71	12.79	27.00	11.85	26.14	11.39	25.29	10.94	23.57	10.05
	-13.7(7.3)	-15(5)	30.43	13.06	28.71	12.15	27.00	11.26	26.14	10.84	25.29	10.41	23.57	9.57
	-11.8(10.8)	-13(8.6)	30.43	12.36	28.71	11.51	27.00	10.68	26.14	10.28	25.29	9.88	23.57	9.14
	-9.8(14.4)	-11(12.2)	30.43	11.68	28.71	10.88	27.00	10.11	26.14	9.72	25.29	9.35	23.57	8.63
	-9.5(14.9)	-10(14)	30.43	11.35	28.71	10.58	27.00	9.82	26.14	9.47	25.29	9.10	23.57	8.38
	-8.5(16.7)	-9.1(15.6)	30.43	11.05	28.71	10.31	27.00	9.58	26.14	9.23	25.29	8.87	23.57	8.18
	-7(19.4)	-7.6(18.3)	30.43	10.57	28.71	9.87	27.00	9.17	26.14	8.84	25.29	8.50	23.57	7.86
	-5(23)	-5.6(21.9)	30.43	9.95	28.71	9.30	27.00	8.65	26.14	8.34	25.29	8.03	23.57	7.43
	-3(26.6)	-3.7(25.3)	30.43	9.40	28.71	8.78	27.00	8.18	26.14	7.90	25.29	7.60	23.57	7.03
	0(32)	-0.7(30.7)	30.43	8.58	28.71	8.04	27.00	7.50	26.14	7.24	25.29	6.97	23.57	6.46
	3(37.4)	2.2(36)	30.43	7.87	28.71	7.39	27.00	6.90	26.14	6.66	25.29	6.43	23.57	5.96
	5(41)	4.1(39.4)	30.43	7.44	28.71	6.99	27.00	6.53	26.14	6.32	25.29	6.09	23.57	5.66
	7(44.6)	6(42.8)	30.43	7.04	28.71	6.62	27.00	6.19	26.14	5.99	25.29	5.79	23.57	5.38
9(48.2)	7.9(46.2)	30.43	6.67	28.71	6.27	27.00	5.87	26.14	5.69	25.29	5.49	23.57	5.12	
11(51.8)	9.8(49.6)	30.43	6.33	28.71	5.96	27.00	5.59	26.14	5.40	25.29	5.22	23.57	4.88	
13(55.4)	11.8(53.2)	30.43	5.99	28.71	5.65	27.00	5.30	26.14	5.13	25.29	4.96	23.57	4.63	
15(59)	13.7(56.7)	30.43	5.70	28.71	5.36	27.00	5.05	26.14	4.89	25.29	4.73	23.57	4.42	
50%	-19.8(-3.6)	-20(-4)	25.35	11.78	23.92	10.97	22.50	10.18	21.65	9.81	20.93	9.42	19.51	8.68
	-18.8(-1.8)	-19(-2.2)	25.35	11.52	23.92	10.74	22.50	9.98	21.65	9.60	20.93	9.23	19.51	8.51
	-16.7(1.9)	-17(1.4)	25.35	10.99	23.92	10.25	22.50	9.54	21.65	9.18	20.93	8.84	19.51	8.16
	-13.7(7.3)	-15(5)	25.35	10.47	23.92	9.77	22.50	9.08	21.65	8.75	20.93	8.43	19.51	7.79
	-11.8(10.8)	-13(8.6)	25.35	9.94	23.92	9.28	22.50	8.64	21.65	8.33	20.93	8.01	19.51	7.41
	-9.8(14.4)	-11(12.2)	25.35	9.41	23.92	8.80	22.50	8.20	21.65	7.90	20.93	7.61	19.51	7.04
	-9.5(14.9)	-10(14)	25.35	9.15	23.92	8.56	22.50	7.98	21.65	7.70	20.93	7.41	19.51	6.86
	-8.5(16.7)	-9.1(15.6)	25.35	8.93	23.92	8.36	22.50	7.79	21.65	7.51	20.93	7.24	19.51	6.70
	-7(19.4)	-7.6(18.3)	25.35	8.56	23.92	8.01	22.50	7.47	21.65	7.22	20.93	6.96	19.51	6.45
	-5(23)	-5.6(21.9)	25.35	8.07	23.92	7.57	22.50	7.07	21.65	6.83	20.93	6.59	19.51	6.10
	-3(26.6)	-3.7(25.3)	25.35	7.64	23.92	7.17	22.50	6.70	21.65	6.47	20.93	6.25	19.51	5.80
	0(32)	-0.7(30.7)	25.35	7.02	23.92	6.59	22.50	6.17	21.65	5.96	20.93	5.76	19.51	5.36
	3(37.4)	2.2(36)	25.35	6.46	23.92	6.07	22.50	5.69	21.65	5.50	20.93	5.32	19.51	4.96
	5(41)	4.1(39.4)	25.35	6.13	23.92	5.76	22.50	5.40	21.65	5.23	20.93	5.06	19.51	4.72
	7(44.6)	6(42.8)	25.35	5.82	23.92	5.48	22.50	5.15	21.65	4.98	20.93	4.82	19.51	4.51
9(48.2)	7.9(46.2)	25.35	5.52	23.92	5.20	22.50	4.89	21.65	4.75	20.93	4.59	19.51	4.29	
11(51.8)	9.8(49.6)	25.35	5.25	23.92	4.95	22.50	4.66	21.65	4.52	20.93	4.38	19.51	4.09	
13(55.4)	11.8(53.2)	25.35	4.99	23.92	4.71	22.50	4.43	21.65	4.31	20.93	4.16	19.51	3.91	
15(59)	13.7(56.7)	25.35	4.75	23.92	4.49	22.50	4.23	21.65	4.11	20.93	3.98	19.51	3.74	

**Heating capacity tables**

**MVD-V5X450W/V2GN1**

TC: Total Capacity (kW); PI: Power Input (kW) (Compressor + Outdoor fan motor)

Combination (%)	Outdoor temperature		Indoor temperature(°C(°F) DB)											
			16(60.8)		18(64.4)		20(68)		21(69.8)		22(71.6)		24(75.2)	
	°C(°F) DB	°C(°F) WB	TC	PI	TC	PI	TC	PI	TC	PI	TC	PI	TC	PI
130%	-19.8(-3.6)	-20(-4)	32.38	9.04	32.22	9.67	32.07	10.32	32.07	10.64	31.91	10.95	31.91	11.60
	-18.8(-1.8)	-19(-2.2)	32.86	9.24	32.70	9.87	32.70	10.50	32.54	10.82	32.54	11.12	32.38	11.75
	-16.7(1.9)	-17(1.4)	34.13	9.67	33.97	10.27	33.81	10.89	33.81	11.19	33.81	11.48	33.65	12.08
	-13.7(7.3)	-15(5)	35.55	10.12	35.40	10.70	35.24	11.29	35.24	11.57	35.08	11.87	35.08	12.45
	-11.8(10.8)	-13(8.6)	36.99	10.57	36.99	11.14	36.83	11.68	36.67	11.97	36.67	12.25	36.51	12.80
	-9.8(14.4)	-11(12.2)	38.73	11.04	38.57	11.57	38.41	12.10	38.41	12.37	38.41	12.63	38.25	13.16
	-9.5(14.9)	-10(14)	39.68	11.27	39.53	11.78	39.37	12.30	39.37	12.56	39.21	12.82	39.21	13.33
	-8.5(16.7)	-9.1(15.6)	40.47	11.47	40.32	11.97	40.32	12.48	40.16	12.73	40.16	12.98	40.00	13.50
	-7(19.4)	-7.6(18.3)	41.91	11.80	41.91	12.30	41.75	12.78	41.75	13.03	41.59	13.26	41.43	13.76
	-5(23)	-5.6(21.9)	44.13	12.25	43.97	12.71	43.81	13.18	43.81	13.41	43.65	13.63	43.65	14.09
	-3(26.6)	-3.7(25.3)	46.19	12.65	46.03	13.10	46.03	13.53	45.87	13.76	45.87	13.98	45.71	14.41
	0(32)	-0.7(30.7)	49.84	13.26	49.84	13.68	49.68	14.08	49.68	14.23	49.52	14.49	49.52	14.89
	3(37.4)	2.2(36)	53.81	13.81	53.65	14.19	53.49	14.58	53.49	14.76	53.49	14.96	53.33	15.32
	5(41)	4.1(39.4)	56.51	14.16	56.35	14.53	56.35	14.88	56.19	15.06	56.19	15.24	56.03	15.59
	7(44.6)	6(42.8)	59.36	14.49	59.21	14.83	59.21	15.17	59.05	15.34	59.05	15.51	56.67	14.89
9(48.2)	7.9(46.2)	62.38	14.79	62.22	15.12	62.22	15.44	62.06	15.61	60.79	15.28	56.67	13.99	
11(51.8)	9.8(49.6)	65.55	15.09	65.40	15.39	65.08	15.59	62.86	14.98	60.79	14.36	56.67	13.18	
13(55.4)	11.8(53.2)	69.04	15.37	68.89	15.67	65.08	14.61	62.86	14.03	60.79	13.48	56.67	12.37	
15(59)	13.7(56.7)	72.38	15.64	69.20	14.84	65.08	13.76	62.86	13.23	60.79	12.70	56.67	11.67	
120%	-19.8(-3.6)	-20(-4)	32.22	9.41	32.06	9.96	31.90	10.52	31.90	10.79	31.90	11.08	31.75	11.65
	-18.8(-1.8)	-19(-2.2)	32.70	9.58	32.54	10.13	32.54	10.68	32.38	10.95	32.38	11.24	32.22	11.79
	-16.7(1.9)	-17(1.4)	33.97	9.96	33.81	10.49	33.60	11.01	33.65	11.28	33.65	11.55	33.49	12.07
	-13.7(7.3)	-15(5)	35.40	10.35	35.24	10.86	35.08	11.36	35.08	11.63	35.08	11.88	34.92	12.39
	-11.8(10.8)	-13(8.6)	36.83	10.75	36.83	11.24	36.67	11.73	36.67	11.98	36.51	12.21	36.51	12.70
	-9.8(14.4)	-11(12.2)	38.57	11.16	38.41	11.61	38.41	12.09	38.25	12.32	38.25	12.55	38.10	13.02
	-9.5(14.9)	-10(14)	39.53	11.36	39.37	11.82	39.21	12.26	39.21	12.50	39.21	12.72	39.05	13.18
	-8.5(16.7)	-9.1(15.6)	40.32	11.53	40.16	11.98	40.16	12.42	40.00	12.64	40.00	12.88	39.84	13.32
	-7(19.4)	-7.6(18.3)	41.75	11.83	41.75	12.26	41.59	12.69	41.59	12.91	41.43	13.11	41.43	13.54
	-5(23)	-5.6(21.9)	43.97	12.21	43.81	12.62	43.65	13.03	43.65	13.24	43.65	13.44	43.50	13.84
	-3(26.6)	-3.7(25.3)	46.04	12.58	46.04	12.97	45.88	13.35	45.88	13.54	45.72	13.74	45.72	14.12
	0(32)	-0.7(30.7)	49.68	13.11	49.68	13.48	49.53	13.82	49.53	14.01	49.37	14.19	49.37	14.55
	3(37.4)	2.2(36)	53.65	13.60	53.49	13.93	53.49	14.27	53.33	14.44	53.33	14.60	52.22	14.52
	5(41)	4.1(39.4)	56.35	13.90	56.19	14.22	56.19	14.53	56.03	14.69	56.03	14.85	52.22	13.63
	7(44.6)	6(42.8)	59.21	14.19	59.21	14.49	59.05	14.79	58.10	14.58	56.19	13.98	52.22	12.83
9(48.2)	7.9(46.2)	62.23	14.47	62.07	14.75	60.00	14.27	58.10	13.70	56.19	13.14	52.22	12.07	
11(51.8)	9.8(49.6)	65.40	14.72	63.81	14.47	60.00	13.41	58.10	12.89	56.19	12.37	52.22	11.38	
13(55.4)	11.8(53.2)	67.78	14.58	63.81	13.57	60.00	12.58	58.10	12.10	56.19	11.63	52.22	10.70	
15(59)	13.7(56.7)	67.78	13.73	63.81	12.78	60.00	11.87	58.10	11.41	56.19	10.97	52.22	10.10	
110%	-19.8(-3.6)	-20(-4)	32.06	10.49	31.91	11.01	31.75	11.55	31.75	11.81	31.76	12.07	31.59	12.60
	-18.8(-1.8)	-19(-2.2)	32.54	10.66	32.38	11.17	32.38	11.69	32.38	11.95	32.22	12.21	32.22	12.73
	-16.7(1.9)	-17(1.4)	33.81	11.01	33.65	11.51	34.12	12.02	33.49	12.26	33.49	12.52	33.33	13.00
	-13.7(7.3)	-15(5)	35.24	11.39	35.09	11.87	34.92	12.34	34.92	12.58	34.92	12.83	34.76	13.30
	-11.8(10.8)	-13(8.6)	36.67	11.77	36.67	12.23	36.51	12.68	36.51	12.91	36.35	13.13	36.35	13.60
	-9.8(14.4)	-11(12.2)	38.41	12.15	38.25	12.58	38.25	13.02	38.09	13.25	38.09	13.46	38.09	13.90
	-9.5(14.9)	-10(14)	39.37	12.34	39.21	12.76	39.05	13.20	39.05	13.41	39.05	13.62	38.89	14.04
	-8.5(16.7)	-9.1(15.6)	40.16	12.50	40.00	12.92	40.00	13.34	39.84	13.56	39.84	13.77	39.84	12.55
	-7(19.4)	-7.6(18.3)	41.59	12.79	41.59	13.18	41.43	13.59	41.43	13.80	41.43	13.99	41.27	14.40
	-5(23)	-5.6(21.9)	43.81	13.15	43.65	13.54	43.49	13.91	43.49	14.11	43.49	14.30	43.33	14.69
	-3(26.6)	-3.7(25.3)	45.88	13.49	45.88	13.85	45.72	14.22	45.72	14.40	45.56	14.58	45.56	14.95
	0(32)	-0.7(30.7)	49.52	13.99	49.52	14.33	49.37	14.67	49.37	14.83	49.37	15.01	47.94	14.72
	3(37.4)	2.2(36)	53.49	14.46	53.33	14.77	53.33	15.08	53.17	15.22	51.43	14.61	47.94	13.39
	5(41)	4.1(39.4)	56.19	14.74	56.19	15.04	55.08	14.90	53.17	14.30	51.43	13.73	47.94	12.60
	7(44.6)	6(42.8)	59.05	15.01	58.57	15.11	55.08	13.99	53.17	13.44	51.43	12.91	47.94	11.85
9(48.2)	7.9(46.2)	62.06	15.26	58.57	14.20	55.08	13.17	53.17	12.65	51.43	12.15	47.94	11.17	
11(51.8)	9.8(49.6)	62.06	14.35	58.57	13.36	55.08	12.39	53.17	11.92	51.43	11.45	47.94	10.54	
13(55.4)	11.8(53.2)	62.06	13.46	58.57	12.53	55.08	11.64	53.17	11.21	51.43	10.77	47.94	9.93	
15(59)	13.7(56.7)	62.06	11.95	58.57	11.82	55.08	11.00	53.17	10.58	51.43	10.19	47.94	9.39	

**Heating capacity tables**

**MVD-V5X450W/V2GN1**

**TC:** Total Capacity (kW); **PI:** Power Input (kW) (Compressor + Outdoor fan motor)

Combination (%)	Outdoor temperature		Indoor temperature(°C(°F) DB)											
			16(60.8)		18(64.4)		20(68)		21(69.8)		22(71.6)		24(75.2)	
	°C(°F) DB	°C(°F) WB	TC	PI	TC	PI	TC	PI	TC	PI	TC	PI	TC	PI
100%	-19.8(-3.6)	-20(-4)	31.91	11.34	31.75	11.81	31.75	12.29	31.59	12.53	31.59	12.76	31.43	13.25
	-18.8(-1.8)	-19(-2.2)	32.38	11.48	32.38	11.95	32.22	12.42	32.22	12.66	32.07	12.91	32.07	13.38
	-16.7(1.9)	-17(1.4)	33.65	11.81	33.49	12.26	33.49	12.71	33.34	12.94	33.34	13.17	33.34	13.62
	-13.7(7.3)	-15(5)	35.08	12.15	34.92	12.58	34.76	13.02	34.76	13.25	34.76	13.46	34.61	13.89
	-11.8(10.8)	-13(8.6)	36.51	12.50	36.51	12.91	36.35	13.33	36.35	13.54	36.35	13.75	36.19	14.17
	-9.8(14.4)	-11(12.2)	38.26	12.84	38.10	13.25	38.10	13.64	38.10	13.85	37.94	14.04	37.94	14.43
	-9.5(14.9)	-10(14)	39.21	13.02	39.05	13.41	39.05	13.80	38.89	13.99	38.89	14.19	38.73	14.57
	-8.5(16.7)	-9.1(15.6)	40.00	13.17	39.84	13.55	39.84	13.93	39.84	14.12	39.69	14.32	39.69	14.69
	-7(19.4)	-7.6(18.3)	41.43	13.43	41.43	13.80	41.27	14.15	41.27	14.35	41.27	14.53	41.11	14.90
	-5(23)	-5.6(21.9)	43.65	13.77	43.49	14.11	43.49	14.46	43.34	14.62	43.34	14.80	43.18	15.16
	-3(26.6)	-3.7(25.3)	45.72	14.07	45.72	12.78	45.56	14.74	45.56	14.90	45.56	15.06	43.65	14.43
	0(32)	-0.7(30.7)	49.37	14.53	49.37	14.83	49.21	15.14	48.42	14.90	46.83	14.28	43.65	13.10
	3(37.4)	2.2(36)	53.34	14.95	53.18	15.22	50.00	14.09	48.42	13.54	46.83	13.00	43.65	11.94
	5(41)	4.1(39.4)	56.03	15.22	53.18	14.30	50.00	13.25	48.42	12.74	46.83	12.24	43.65	11.26
	7(44.6)	6(42.8)	56.35	14.45	53.18	13.44	50.00	12.47	48.42	12.00	46.83	11.53	43.65	10.61
9(48.2)	7.9(46.2)	56.35	13.57	53.18	12.65	50.00	11.74	48.42	11.16	46.83	10.87	43.65	10.01	
11(51.8)	9.8(49.6)	56.35	12.78	53.18	11.92	50.00	11.08	48.42	10.66	46.83	10.25	43.65	9.46	
13(55.4)	11.8(53.2)	56.35	12.00	53.18	11.21	50.00	10.43	48.42	10.04	46.83	9.67	43.65	8.92	
15(59)	13.7(56.7)	56.35	11.32	53.18	10.58	50.00	9.85	48.42	9.49	46.83	9.13	43.65	8.45	
90%	-19.8(-3.6)	-20(-4)	31.69	12.18	31.53	12.60	31.53	13.04	31.37	13.25	31.37	13.47	31.37	13.90
	-18.8(-1.8)	-19(-2.2)	32.17	12.31	32.17	12.74	32.01	13.17	32.01	13.38	32.01	13.59	31.85	14.01
	-16.7(1.9)	-17(1.4)	33.44	12.62	33.27	13.02	33.27	13.43	33.27	13.64	33.12	13.83	33.12	14.23
	-13.7(7.3)	-15(5)	34.86	12.92	34.70	13.31	34.70	13.70	34.54	13.89	34.54	14.09	34.54	14.48
	-11.8(10.8)	-13(8.6)	36.28	13.23	36.28	13.60	36.13	13.98	36.13	14.17	36.13	14.35	35.97	14.72
	-9.8(14.4)	-11(12.2)	38.03	13.54	38.03	13.90	37.87	14.25	37.87	14.43	37.87	14.62	37.71	14.98
	-9.5(14.9)	-10(14)	38.98	13.70	38.82	14.06	38.82	14.40	38.66	14.57	38.66	14.75	38.66	15.09
	-8.5(16.7)	-9.1(15.6)	39.77	13.85	39.77	14.19	39.61	14.53	39.61	14.69	39.61	14.87	39.14	15.01
	-7(19.4)	-7.6(18.3)	41.20	14.07	41.20	14.40	41.04	14.74	41.04	14.90	41.04	15.06	39.14	14.33
	-5(23)	-5.6(21.9)	43.42	14.38	43.26	14.69	43.26	15.00	43.10	15.16	41.99	14.69	39.14	13.47
	-3(26.6)	-3.7(25.3)	45.48	14.66	45.48	14.95	45.00	15.01	43.42	14.41	41.99	13.83	39.14	12.70
	0(32)	-0.7(30.7)	49.28	15.08	47.85	14.70	45.00	13.62	43.42	13.08	41.99	12.57	39.14	11.55
	3(37.4)	2.2(36)	50.71	14.36	47.85	13.38	45.00	12.41	43.42	11.94	41.99	11.47	39.14	10.56
	5(41)	4.1(39.4)	50.71	13.51	47.85	12.58	45.00	11.69	43.42	11.24	41.99	10.82	39.14	9.96
	7(44.6)	6(42.8)	50.71	12.70	47.85	11.85	45.00	11.01	43.42	10.61	41.99	10.20	39.14	9.41
9(48.2)	7.9(46.2)	50.71	11.97	47.85	11.16	45.00	10.38	43.42	10.01	41.99	9.64	39.14	8.89	
11(51.8)	9.8(49.6)	50.71	11.27	47.85	10.53	45.00	9.81	43.42	9.46	41.99	9.10	39.14	8.42	
13(55.4)	11.8(53.2)	50.71	10.61	47.85	9.93	45.00	9.25	43.42	8.92	41.99	8.60	39.14	7.95	
15(59)	13.7(56.7)	50.71	10.02	47.85	9.38	45.00	8.76	43.42	8.45	41.99	8.15	39.14	7.55	
80%	-19.8(-3.6)	-20(-4)	31.59	13.02	31.43	13.39	31.43	13.78	31.43	13.98	31.27	14.17	31.27	14.54
	-18.8(-1.8)	-19(-2.2)	32.06	13.13	32.06	13.52	31.90	13.89	31.90	14.09	31.90	14.27	31.75	14.66
	-16.7(1.9)	-17(1.4)	33.33	13.41	33.18	13.77	33.18	14.14	33.18	14.32	33.18	14.49	33.02	14.85
	-13.7(7.3)	-15(5)	34.76	13.68	34.60	14.02	34.60	14.38	34.60	14.54	34.44	14.72	34.44	15.08
	-11.8(10.8)	-13(8.6)	36.19	13.96	36.19	14.30	36.03	14.62	36.03	14.78	36.03	14.96	34.92	14.56
	-9.8(14.4)	-11(12.2)	37.94	14.23	37.94	14.56	37.78	14.88	37.78	15.03	37.46	15.00	34.92	13.75
	-9.5(14.9)	-10(14)	38.89	14.38	38.72	14.69	38.73	15.00	38.73	15.16	37.46	14.56	34.92	13.34
	-8.5(16.7)	-9.1(15.6)	39.68	14.51	36.88	14.82	39.52	15.11	38.73	14.77	37.46	14.17	34.92	12.99
	-7(19.4)	-7.6(18.3)	41.11	14.72	41.11	15.01	40.00	14.69	38.73	14.10	37.46	13.54	34.92	12.42
	-5(23)	-5.6(21.9)	43.33	14.98	42.54	14.90	40.00	13.80	38.73	13.26	37.46	12.73	34.92	11.69
	-3(26.6)	-3.7(25.3)	45.08	15.06	42.54	14.02	40.00	12.99	38.73	12.50	37.46	12.00	34.92	11.04
	0(32)	-0.7(30.7)	45.08	13.67	42.54	12.73	40.00	11.82	38.73	11.38	37.46	10.93	34.92	10.07
	3(37.4)	2.2(36)	45.08	12.45	42.54	11.61	40.00	10.80	38.73	10.40	37.46	10.01	34.92	9.23
	5(41)	4.1(39.4)	45.08	11.73	42.54	10.95	40.00	10.19	38.73	9.81	37.46	9.46	34.92	8.73
	7(44.6)	6(42.8)	45.08	11.04	42.54	10.33	40.00	9.62	38.73	9.28	37.46	8.94	34.92	8.26
9(48.2)	7.9(46.2)	45.08	10.43	42.54	9.75	40.00	9.08	38.73	8.76	37.46	8.45	34.92	7.82	
11(51.8)	9.8(49.6)	45.08	9.85	42.54	9.21	40.00	8.60	38.73	8.29	37.46	8.00	34.92	7.42	
13(55.4)	11.8(53.2)	45.08	9.28	42.54	8.70	40.00	8.13	38.73	7.84	37.46	7.56	34.92	7.01	
15(59)	13.7(56.7)	45.08	8.78	42.54	8.24	40.00	7.71	38.73	7.43	37.46	7.17	34.92	6.67	

**Heating capacity tables**

**MVD-V5X450W/V2GN1**

**TC:** Total Capacity (kW); **PI:** Power Input (kW) (Compressor + Outdoor fan motor)

Combination (%)	Outdoor temperature		Indoor temperature(°C(°F) DB)											
			16(60.8)		18(64.4)		20(68)		21(69.8)		22(71.6)		24(75.2)	
	°C(°F) DB	°C(°F) WB	TC	PI	TC	PI	TC	PI	TC	PI	TC	PI	TC	PI
70%	-19.8(-3.6)	-20(-4)	31.36	13.86	31.20	14.19	31.20	14.53	31.20	14.69	31.20	14.87	30.41	14.70
	-18.8(-1.8)	-19(-2.2)	31.83	13.97	31.83	14.30	31.68	14.62	31.68	14.79	31.68	14.96	30.41	14.40
	-16.7(1.9)	-17(1.4)	33.10	14.20	33.10	14.53	32.94	14.83	32.94	15.00	32.62	13.36	30.41	13.73
	-13.7(7.3)	-15(5)	34.52	14.45	34.37	14.75	34.37	15.06	33.73	14.83	32.62	14.23	30.41	13.05
	-11.8(10.8)	-13(8.6)	35.95	14.69	35.95	14.98	35.00	14.62	33.73	14.06	32.62	13.49	30.41	12.37
	-9.8(14.4)	-11(12.2)	37.69	14.93	37.22	14.91	35.00	13.81	33.73	13.28	32.62	12.74	30.41	11.71
	-9.5(14.9)	-10(14)	38.64	15.06	37.22	14.48	35.00	13.41	33.73	12.89	32.62	12.39	30.41	11.38
	-8.5(16.7)	-9.1(15.6)	39.43	15.14	37.22	14.09	35.00	13.05	33.73	12.55	32.62	12.06	30.41	11.09
	-7(19.4)	-7.6(18.3)	39.43	14.46	37.22	13.46	35.00	12.49	33.73	12.02	32.62	11.55	30.41	10.62
	-5(23)	-5.6(21.9)	39.43	13.59	37.22	12.66	35.00	11.76	33.73	11.30	32.62	13.35	30.41	10.02
	-3(26.6)	-3.7(25.3)	39.43	12.79	37.22	11.94	35.00	11.09	33.73	10.67	32.62	10.27	30.41	9.47
	0(32)	-0.7(30.7)	39.43	11.64	37.22	10.88	35.00	10.12	33.73	9.75	32.62	9.39	30.41	8.68
	3(37.4)	2.2(36)	39.43	10.64	37.22	9.96	35.00	9.28	33.73	8.94	32.62	8.61	30.41	7.97
	5(41)	4.1(39.4)	39.43	10.04	37.22	9.39	35.00	8.78	33.73	8.45	32.62	8.15	30.41	7.55
	7(44.6)	6(42.8)	39.43	9.49	37.22	8.89	35.00	8.29	33.73	8.00	32.62	7.72	30.41	7.16
9(48.2)	7.9(46.2)	39.43	8.97	37.22	8.40	35.00	7.85	33.73	7.58	32.62	7.32	30.41	6.79	
11(51.8)	9.8(49.6)	39.43	8.49	37.22	7.95	35.00	7.45	33.73	7.19	32.62	6.95	30.41	6.44	
13(55.4)	11.8(53.2)	39.43	8.02	37.22	7.53	35.00	7.04	33.73	6.82	32.62	6.58	30.41	6.12	
15(59)	13.7(56.7)	39.43	7.59	37.22	7.14	35.00	6.69	33.73	6.48	32.62	6.25	30.41	5.83	
60%	-19.8(-3.6)	-20(-4)	31.27	14.70	31.11	14.98	30.00	14.41	29.05	13.85	28.10	13.30	26.19	12.19
	-18.8(-1.8)	-19(-2.2)	31.75	14.80	31.75	15.08	30.00	14.10	29.05	13.55	28.10	13.00	26.19	11.94
	-16.7(1.9)	-17(1.4)	33.02	15.00	31.91	14.53	30.00	13.46	29.05	12.94	28.10	12.42	26.19	11.42
	-13.7(7.3)	-15(5)	33.81	14.83	31.91	13.80	30.00	12.79	29.05	12.31	28.10	11.82	26.19	10.87
	-11.8(10.8)	-13(8.6)	33.81	14.04	31.91	13.07	30.00	12.13	29.05	11.68	28.10	11.22	26.19	10.38
	-9.8(14.4)	-11(12.2)	33.81	13.26	31.91	12.36	30.00	11.48	29.05	11.04	28.10	10.62	26.19	9.80
	-9.5(14.9)	-10(14)	33.81	12.89	31.91	12.02	30.00	11.16	29.05	10.75	28.10	10.33	26.19	9.52
	-8.5(16.7)	-9.1(15.6)	33.81	12.55	31.91	11.71	30.00	10.88	29.05	10.48	28.10	10.07	26.19	9.30
	-7(19.4)	-7.6(18.3)	33.81	12.00	31.91	11.21	30.00	10.41	29.05	10.04	28.10	9.65	26.19	8.92
	-5(23)	-5.6(21.9)	33.81	11.30	31.91	10.56	30.00	9.83	29.05	9.47	28.10	9.12	26.19	8.44
	-3(26.6)	-3.7(25.3)	33.81	10.67	31.91	9.98	30.00	9.30	29.05	8.97	28.10	8.63	26.19	7.98
	0(32)	-0.7(30.7)	33.81	9.75	31.91	9.13	30.00	8.52	29.05	8.23	28.10	7.92	26.19	7.34
	3(37.4)	2.2(36)	33.81	8.94	31.91	8.39	30.00	7.84	29.05	7.56	28.10	7.30	26.19	6.77
	5(41)	4.1(39.4)	33.81	8.45	31.91	7.93	30.00	7.42	29.05	7.17	28.10	6.91	26.19	6.43
	7(44.6)	6(42.8)	33.81	8.00	31.91	7.51	30.00	7.03	29.05	6.80	28.10	6.57	26.19	6.11
9(48.2)	7.9(46.2)	33.81	7.58	31.91	7.13	30.00	6.67	29.05	6.46	28.10	6.23	26.19	5.81	
11(51.8)	9.8(49.6)	33.81	7.19	31.91	6.77	30.00	6.35	29.05	6.14	28.10	5.93	26.19	5.54	
13(55.4)	11.8(53.2)	33.81	6.80	31.91	6.41	30.00	6.02	29.05	5.83	28.10	5.64	26.19	5.26	
15(59)	13.7(56.7)	33.81	6.48	31.91	6.09	30.00	5.73	29.05	5.55	28.10	5.38	26.19	5.02	
50%	-19.8(-3.6)	-20(-4)	28.17	13.38	26.58	12.45	25.00	11.56	24.05	11.14	23.26	10.70	21.68	9.86
	-18.8(-1.8)	-19(-2.2)	28.17	13.08	26.58	12.19	25.00	11.34	24.05	10.90	23.26	10.48	21.68	9.67
	-16.7(1.9)	-17(1.4)	28.17	12.49	26.58	11.64	25.00	10.83	24.05	10.43	23.26	10.04	21.68	9.26
	-13.7(7.3)	-15(5)	28.17	11.89	26.58	11.09	25.00	10.32	24.05	9.94	23.26	9.57	21.68	8.84
	-11.8(10.8)	-13(8.6)	28.17	11.29	26.58	10.54	25.00	9.81	24.05	9.46	23.26	9.10	21.68	8.42
	-9.8(14.4)	-11(12.2)	28.17	10.69	26.58	9.99	25.00	9.31	24.05	8.97	23.26	8.65	21.68	8.00
	-9.5(14.9)	-10(14)	28.17	10.40	26.58	9.72	25.00	9.07	24.05	8.74	23.26	8.42	21.68	7.79
	-8.5(16.7)	-9.1(15.6)	28.17	10.14	26.58	9.49	25.00	8.84	24.05	8.53	23.26	8.23	21.68	7.61
	-7(19.4)	-7.6(18.3)	28.17	9.72	26.58	9.10	25.00	8.49	24.05	8.19	23.26	7.90	21.68	7.32
	-5(23)	-5.6(21.9)	28.17	9.17	26.58	8.60	25.00	8.03	24.05	7.76	23.26	7.48	21.68	6.93
	-3(26.6)	-3.7(25.3)	28.17	8.68	26.58	8.15	25.00	7.61	24.05	7.35	23.26	7.09	21.68	6.59
	0(32)	-0.7(30.7)	28.17	7.97	26.58	7.48	25.00	7.01	24.05	6.77	23.26	6.54	21.68	6.09
	3(37.4)	2.2(36)	28.17	7.34	26.58	6.90	25.00	6.46	24.05	6.25	23.26	6.04	21.68	5.64
	5(41)	4.1(39.4)	28.17	6.96	26.58	6.54	25.00	6.14	24.05	5.94	23.26	5.75	21.68	5.36
	7(44.6)	6(42.8)	28.17	6.61	26.58	6.22	25.00	5.85	24.05	5.65	23.26	5.47	21.68	5.12
9(48.2)	7.9(46.2)	28.17	6.27	26.58	5.91	25.00	5.55	24.05	5.39	23.26	5.21	21.68	4.87	
11(51.8)	9.8(49.6)	28.17	5.96	26.58	5.62	25.00	5.30	24.05	5.13	23.26	4.97	21.68	4.65	
13(55.4)	11.8(53.2)	28.17	5.67	26.58	5.34	25.00	5.04	24.05	4.89	23.26	4.73	21.68	4.44	
15(59)	13.7(56.7)	28.17	5.39	26.58	5.10	25.00	4.81	24.05	4.66	23.26	4.52	21.68	4.24	

**Heating capacity tables**

**MVD-V5X500W/V2GN1**

**TC:** Total Capacity (kW); **PI:** Power Input (kW) (Compressor + Outdoor fan motor)

Combination (%)	Outdoor temperature		Indoor temperature(°C(°F) DB)											
			16(60.8)		18(64.4)		20(68)		21(69.8)		22(71.6)		24(75.2)	
	°C(°F) DB	°C(°F) WB	TC	PI	TC	PI	TC	PI	TC	PI	TC	PI	TC	PI
130%	-19.8(-3.6)	-20(-4)	36.26	10.26	36.09	10.98	35.91	11.71	35.91	12.07	35.73	12.43	35.73	13.16
	-18.8(-1.8)	-19(-2.2)	36.80	10.49	36.62	11.20	36.62	11.92	36.44	12.28	36.44	12.62	36.26	13.33
	-16.7(1.9)	-17(1.4)	38.22	10.98	38.04	11.66	37.86	12.35	37.86	12.69	37.86	13.03	37.69	13.71
	-13.7(7.3)	-15(5)	39.82	11.49	39.65	12.15	39.47	12.81	39.47	13.13	39.29	13.47	39.29	14.13
	-11.8(10.8)	-13(8.6)	41.42	11.99	41.42	12.64	41.24	13.26	41.07	13.58	41.07	13.90	40.89	14.52
	-9.8(14.4)	-11(12.2)	43.38	12.52	43.20	13.13	43.02	13.73	43.02	14.03	43.02	14.33	42.84	14.94
	-9.5(14.9)	-10(14)	44.44	12.79	44.27	13.37	44.09	13.96	44.09	14.26	43.91	14.54	43.91	15.13
	-8.5(16.7)	-9.1(15.6)	45.33	13.01	45.16	13.58	45.16	14.16	44.98	14.45	44.98	14.73	44.80	15.31
	-7(19.4)	-7.6(18.3)	46.93	13.39	46.93	13.96	46.75	14.50	46.75	14.79	46.58	15.05	46.40	15.62
	-5(23)	-5.6(21.9)	49.42	13.90	49.24	14.43	49.06	14.96	49.06	15.22	48.89	15.46	48.89	15.99
	-3(26.6)	-3.7(25.3)	51.73	14.35	51.56	14.86	51.56	15.35	51.38	15.62	51.38	15.86	51.20	16.35
	0(32)	-0.7(30.7)	55.82	15.05	55.82	15.52	55.64	15.97	55.64	16.14	55.47	16.45	55.47	16.90
	3(37.4)	2.2(36)	60.26	15.67	60.09	16.11	59.91	16.54	59.91	16.75	59.91	16.97	59.73	17.39
	5(41)	4.1(39.4)	63.29	16.07	63.11	16.48	63.11	16.88	62.93	17.09	62.93	17.29	62.76	17.69
	7(44.6)	6(42.8)	66.49	16.45	66.31	16.82	66.31	17.22	66.13	17.41	66.13	17.60	63.46	16.90
9(48.2)	7.9(46.2)	69.86	16.79	69.68	17.16	69.68	17.52	69.51	17.71	68.09	17.33	63.46	15.88	
11(51.8)	9.8(49.6)	73.42	17.12	73.25	17.46	72.89	17.69	70.40	16.99	68.09	16.29	63.46	14.96	
13(55.4)	11.8(53.2)	77.33	17.44	77.15	17.79	72.89	16.58	70.40	15.92	68.09	15.30	63.46	14.03	
15(59)	13.7(56.7)	81.06	17.75	77.51	16.84	72.89	15.62	70.40	15.01	68.09	14.41	63.46	13.24	
120%	-19.8(-3.6)	-20(-4)	36.09	10.67	35.91	11.30	35.73	11.94	35.73	12.25	35.73	12.57	35.55	13.21
	-18.8(-1.8)	-19(-2.2)	36.63	10.87	36.45	11.50	36.45	12.12	36.27	12.43	36.27	12.75	36.09	13.38
	-16.7(1.9)	-17(1.4)	38.05	11.30	37.87	11.91	37.63	12.50	37.69	12.80	37.69	13.11	37.51	13.70
	-13.7(7.3)	-15(5)	39.65	11.75	39.47	12.32	39.29	12.89	39.29	13.20	39.29	13.48	39.11	14.06
	-11.8(10.8)	-13(8.6)	41.25	12.19	41.25	12.75	41.07	13.30	41.07	13.59	40.89	13.86	40.89	14.41
	-9.8(14.4)	-11(12.2)	43.20	12.66	43.02	13.18	43.02	13.72	42.84	13.98	42.84	14.24	42.67	14.77
	-9.5(14.9)	-10(14)	44.27	12.89	44.09	13.41	43.91	13.91	43.91	14.18	43.91	14.43	43.74	14.95
	-8.5(16.7)	-9.1(15.6)	45.16	13.09	44.98	13.59	44.98	14.09	44.80	14.34	44.80	14.61	44.62	15.11
	-7(19.4)	-7.6(18.3)	46.76	13.43	46.76	13.91	46.58	14.40	46.58	14.65	46.40	14.88	46.40	15.36
	-5(23)	-5.6(21.9)	49.24	13.86	49.07	14.32	48.89	14.79	48.89	15.02	48.89	15.26	48.72	15.70
	-3(26.6)	-3.7(25.3)	51.56	14.27	51.56	14.72	51.38	15.15	51.38	15.36	51.20	15.60	51.20	16.03
	0(32)	-0.7(30.7)	55.65	14.88	55.65	15.29	55.47	15.69	55.47	15.90	55.29	16.10	55.29	16.51
	3(37.4)	2.2(36)	60.09	15.44	59.91	15.81	59.91	16.19	59.73	16.38	59.73	16.56	58.49	16.47
	5(41)	4.1(39.4)	63.11	15.77	62.94	16.13	62.94	16.49	62.76	16.67	62.76	16.85	58.49	15.47
	7(44.6)	6(42.8)	66.31	16.10	66.31	16.44	66.14	16.78	65.07	16.54	62.94	15.86	58.49	14.56
9(48.2)	7.9(46.2)	69.69	16.42	69.52	16.74	67.20	16.19	65.07	15.55	62.94	14.92	58.49	13.70	
11(51.8)	9.8(49.6)	73.25	16.71	71.47	16.42	67.20	15.22	65.07	14.63	62.94	14.04	58.49	12.91	
13(55.4)	11.8(53.2)	75.91	16.54	71.47	15.40	67.20	14.27	65.07	13.73	62.94	13.20	58.49	12.14	
15(59)	13.7(56.7)	75.91	15.58	71.47	14.50	67.20	13.47	65.07	12.95	62.94	12.44	58.49	11.46	
110%	-19.8(-3.6)	-20(-4)	35.91	11.91	35.74	12.50	35.56	13.10	35.56	13.40	35.57	13.69	35.38	14.30
	-18.8(-1.8)	-19(-2.2)	36.45	12.09	36.27	12.68	36.27	13.27	36.27	13.56	36.09	13.86	36.09	14.44
	-16.7(1.9)	-17(1.4)	37.87	12.50	37.69	13.07	38.22	13.64	37.51	13.91	37.51	14.21	37.33	14.76
	-13.7(7.3)	-15(5)	39.47	12.92	39.30	13.47	39.11	14.00	39.11	14.28	39.11	14.56	38.93	15.09
	-11.8(10.8)	-13(8.6)	41.07	13.36	41.07	13.87	40.89	14.39	40.89	14.65	40.71	14.90	40.71	15.44
	-9.8(14.4)	-11(12.2)	43.02	13.78	42.84	14.28	42.84	14.78	42.66	15.03	42.66	15.27	42.66	15.77
	-9.5(14.9)	-10(14)	44.09	14.00	43.91	14.48	43.73	14.98	43.73	15.22	43.73	15.46	43.56	15.93
	-8.5(16.7)	-9.1(15.6)	44.98	14.19	44.80	14.66	44.80	15.14	44.62	15.38	44.62	15.62	44.62	14.24
	-7(19.4)	-7.6(18.3)	46.58	14.52	46.58	14.96	46.40	15.42	46.40	15.66	46.40	15.88	46.22	16.34
	-5(23)	-5.6(21.9)	49.07	14.92	48.89	15.36	48.71	15.79	48.71	16.01	48.71	16.23	48.53	16.67
	-3(26.6)	-3.7(25.3)	51.38	15.31	51.38	15.71	51.20	16.13	51.20	16.34	51.02	16.54	51.02	16.96
	0(32)	-0.7(30.7)	55.47	15.88	55.47	16.26	55.29	16.65	55.29	16.83	55.29	17.04	53.69	16.70
	3(37.4)	2.2(36)	59.91	16.41	59.73	16.76	59.73	17.11	59.56	17.27	57.60	16.58	53.69	15.20
	5(41)	4.1(39.4)	62.94	16.72	62.94	17.07	61.69	16.91	59.56	16.23	57.60	15.58	53.69	14.30
	7(44.6)	6(42.8)	66.13	17.04	65.60	17.15	61.69	15.88	59.56	15.25	57.60	14.65	53.69	13.45
9(48.2)	7.9(46.2)	69.51	17.31	65.60	16.12	61.69	14.94	59.56	14.35	57.60	13.78	53.69	12.68	
11(51.8)	9.8(49.6)	69.51	16.28	65.60	15.16	61.69	14.06	59.56	13.53	57.60	12.99	53.69	11.96	
13(55.4)	11.8(53.2)	69.51	15.27	65.60	14.22	61.69	13.21	59.56	12.72	57.60	12.22	53.69	11.27	
15(59)	13.7(56.7)	69.51	13.56	65.60	13.42	61.69	12.48	59.56	12.00	57.60	11.56	53.69	10.66	

**Heating capacity tables**

**MVD-V5X500W/V2GN1**

TC: Total Capacity (kW); PI: Power Input (kW) (Compressor + Outdoor fan motor)

Combination (%)	Outdoor temperature		Indoor temperature(°C(°F) DB)											
			16(60.8)		18(64.4)		20(68)		21(69.8)		22(71.6)		24(75.2)	
	°C(°F) DB	°C(°F) WB	TC	PI	TC	PI	TC	PI	TC	PI	TC	PI	TC	PI
100%	-19.8(-3.6)	-20(-4)	35.73	12.86	35.55	13.40	35.55	13.95	35.38	14.22	35.38	14.48	35.20	15.03
	-18.8(-1.8)	-19(-2.2)	36.27	13.03	36.27	13.56	36.09	14.09	36.09	14.37	35.91	14.65	35.91	15.18
	-16.7(1.9)	-17(1.4)	37.69	13.40	37.51	13.91	37.51	14.43	37.34	14.68	37.34	14.94	37.34	15.45
	-13.7(7.3)	-15(5)	39.29	13.78	39.11	14.28	38.93	14.78	38.93	15.03	38.93	15.27	38.76	15.77
	-11.8(10.8)	-13(8.6)	40.89	14.19	40.89	14.65	40.71	15.12	40.71	15.36	40.71	15.60	40.53	16.08
	-9.8(14.4)	-11(12.2)	42.85	14.57	42.67	15.03	42.67	15.47	42.67	15.71	42.49	15.93	42.49	16.37
	-9.5(14.9)	-10(14)	43.91	14.78	43.74	15.22	43.74	15.66	43.56	15.88	43.56	16.10	43.38	16.54
	-8.5(16.7)	-9.1(15.6)	44.80	14.94	44.62	15.38	44.62	15.80	44.62	16.02	44.45	16.25	44.45	16.67
	-7(19.4)	-7.6(18.3)	46.40	15.23	46.40	15.66	46.22	16.06	46.22	16.28	46.22	16.48	46.04	16.91
	-5(23)	-5.6(21.9)	48.89	15.62	48.71	16.01	48.71	16.41	48.54	16.59	48.54	16.80	48.36	17.20
	-3(26.6)	-3.7(25.3)	51.20	15.97	51.20	14.50	51.02	16.72	51.02	16.91	51.02	17.09	48.89	16.37
	0(32)	-0.7(30.7)	55.29	16.48	55.29	16.83	55.11	17.18	54.22	16.91	52.44	16.21	48.89	14.87
	3(37.4)	2.2(36)	59.74	16.96	59.56	17.27	56.00	15.99	54.22	15.36	52.44	14.76	48.89	13.54
	5(41)	4.1(39.4)	62.75	17.27	59.56	16.23	56.00	15.03	54.22	14.46	52.44	13.89	48.89	12.77
	7(44.6)	6(42.8)	63.11	16.39	59.56	15.25	56.00	14.15	54.22	13.62	52.44	13.08	48.89	12.04
9(48.2)	7.9(46.2)	63.11	15.40	59.56	14.35	56.00	13.32	54.22	12.66	52.44	12.33	48.89	11.36	
11(51.8)	9.8(49.6)	63.11	14.50	59.56	13.52	56.00	12.57	54.22	12.09	52.44	11.63	48.89	10.73	
13(55.4)	11.8(53.2)	63.11	13.62	59.56	12.72	56.00	11.84	54.22	11.39	52.44	10.97	48.89	10.13	
15(59)	13.7(56.7)	63.11	12.85	59.56	12.00	56.00	11.17	54.22	10.77	52.44	10.36	48.89	9.59	
90%	-19.8(-3.6)	-20(-4)	35.49	13.82	35.32	14.30	35.32	14.79	35.14	15.03	35.14	15.29	35.14	15.77
	-18.8(-1.8)	-19(-2.2)	36.03	13.97	36.03	14.46	35.85	14.94	35.85	15.18	35.85	15.42	35.67	15.90
	-16.7(1.9)	-17(1.4)	37.45	14.32	37.27	14.78	37.27	15.23	37.27	15.47	37.09	15.69	37.09	16.15
	-13.7(7.3)	-15(5)	39.04	14.66	38.86	15.11	38.86	15.55	38.69	15.77	38.69	15.99	38.69	16.43
	-11.8(10.8)	-13(8.6)	40.64	15.01	40.64	15.44	40.46	15.86	40.46	16.08	40.46	16.28	40.28	16.70
	-9.8(14.4)	-11(12.2)	42.59	15.36	42.59	15.77	42.41	16.17	42.41	16.37	42.41	16.59	42.24	17.00
	-9.5(14.9)	-10(14)	43.66	15.55	43.48	15.95	43.48	16.34	43.30	16.54	43.30	16.74	43.30	17.13
	-8.5(16.7)	-9.1(15.6)	44.54	15.71	44.54	16.10	44.37	16.48	44.37	16.67	44.37	16.87	43.83	17.03
	-7(19.4)	-7.6(18.3)	46.14	15.97	46.14	16.34	45.96	16.72	45.96	16.91	45.96	17.09	43.83	16.26
	-5(23)	-5.6(21.9)	48.63	16.32	48.45	16.67	48.45	17.02	48.27	17.20	47.03	16.67	43.83	15.29
	-3(26.6)	-3.7(25.3)	50.93	16.63	50.93	16.96	50.40	17.03	48.63	16.35	47.03	15.69	43.83	14.41
	0(32)	-0.7(30.7)	55.19	17.11	53.60	16.69	50.40	15.45	48.63	14.85	47.03	14.26	43.83	13.10
	3(37.4)	2.2(36)	56.79	16.30	53.60	15.18	50.40	14.08	48.63	13.54	47.03	13.01	43.83	11.98
	5(41)	4.1(39.4)	56.79	15.33	53.60	14.28	50.40	13.27	48.63	12.75	47.03	12.28	43.83	11.30
	7(44.6)	6(42.8)	56.79	14.41	53.60	13.45	50.40	12.50	48.63	12.04	47.03	11.58	43.83	10.68
9(48.2)	7.9(46.2)	56.79	13.58	53.60	12.66	50.40	11.78	48.63	11.36	47.03	10.93	43.83	10.09	
11(51.8)	9.8(49.6)	56.79	12.79	53.60	11.94	50.40	11.14	48.63	10.73	47.03	10.33	43.83	9.56	
13(55.4)	11.8(53.2)	56.79	12.04	53.60	11.27	50.40	10.49	48.63	10.13	47.03	9.76	43.83	9.02	
15(59)	13.7(56.7)	56.79	11.37	53.60	10.64	50.40	9.94	48.63	9.59	47.03	9.24	43.83	8.56	
80%	-19.8(-3.6)	-20(-4)	35.38	14.77	35.20	15.20	35.20	15.64	35.20	15.86	35.02	16.08	35.02	16.50
	-18.8(-1.8)	-19(-2.2)	35.91	14.90	35.91	15.34	35.73	15.77	35.73	15.99	35.73	16.19	35.56	16.63
	-16.7(1.9)	-17(1.4)	37.33	15.21	37.16	15.62	37.16	16.04	37.16	16.24	37.16	16.45	36.98	16.85
	-13.7(7.3)	-15(5)	38.93	15.53	38.76	15.91	38.76	16.32	38.76	16.50	38.58	16.70	38.58	17.11
	-11.8(10.8)	-13(8.6)	40.54	15.84	40.54	16.23	40.36	16.59	40.36	16.78	40.36	16.98	39.11	16.52
	-9.8(14.4)	-11(12.2)	42.49	16.15	42.49	16.52	42.31	16.89	42.31	17.05	41.96	17.02	39.11	15.60
	-9.5(14.9)	-10(14)	43.55	16.32	43.37	16.67	43.38	17.02	43.38	17.20	41.96	16.52	39.11	15.14
	-8.5(16.7)	-9.1(15.6)	44.45	16.46	44.31	16.81	44.27	17.14	43.38	16.76	41.96	16.08	39.11	14.74
	-7(19.4)	-7.6(18.3)	46.05	16.70	46.05	17.03	44.80	16.67	43.38	16.01	41.96	15.36	39.11	14.09
	-5(23)	-5.6(21.9)	48.53	17.00	47.64	16.91	44.80	15.66	43.38	15.05	41.96	14.44	39.11	13.27
	-3(26.6)	-3.7(25.3)	50.49	17.09	47.64	15.91	44.80	14.74	43.38	14.19	41.96	13.62	39.11	12.53
	0(32)	-0.7(30.7)	50.49	15.51	47.64	14.44	44.80	13.41	43.38	12.92	41.96	12.40	39.11	11.43
	3(37.4)	2.2(36)	50.49	14.13	47.64	13.18	44.80	12.26	43.38	11.80	41.96	11.36	39.11	10.47
	5(41)	4.1(39.4)	50.49	13.30	47.64	12.42	44.80	11.56	43.38	11.14	41.96	10.73	39.11	9.90
	7(44.6)	6(42.8)	50.49	12.53	47.64	11.72	44.80	10.92	43.38	10.53	41.96	10.14	39.11	9.37
9(48.2)	7.9(46.2)	50.49	11.83	47.64	11.06	44.80	10.31	43.38	9.94	41.96	9.59	39.11	8.88	
11(51.8)	9.8(49.6)	50.49	11.17	47.64	10.46	44.80	9.76	43.38	9.41	41.96	9.08	39.11	8.42	
13(55.4)	11.8(53.2)	50.49	10.53	47.64	9.87	44.80	9.22	43.38	8.89	41.96	8.58	39.11	7.96	
15(59)	13.7(56.7)	50.49	9.96	47.64	9.35	44.80	8.75	43.38	8.43	41.96	8.14	39.11	7.57	

**Heating capacity tables**

**MVD-V5X500W/V2GN1**

TC: Total Capacity (kW); PI: Power Input (kW) (Compressor + Outdoor fan motor)

Combination (%)	Outdoor temperature		Indoor temperature(°C(°F) DB)											
			16(60.8)		18(64.4)		20(68)		21(69.8)		22(71.6)		24(75.2)	
	°C(°F) DB	°C(°F) WB	TC	PI	TC	PI	TC	PI	TC	PI	TC	PI	TC	PI
70%	-19.8(-3.6)	-20(-4)	35.12	15.73	34.94	16.10	34.94	16.48	34.94	16.67	34.94	16.87	34.06	16.68
	-18.8(-1.8)	-19(-2.2)	35.65	15.86	35.65	16.23	35.48	16.59	35.48	16.78	35.48	16.98	34.06	16.34
	-16.7(1.9)	-17(1.4)	37.07	16.12	37.07	16.48	36.90	16.83	36.90	17.02	36.54	15.16	34.06	15.58
	-13.7(7.3)	-15(5)	38.67	16.39	38.49	16.74	38.49	17.09	37.78	16.83	36.54	16.15	34.06	14.81
	-11.8(10.8)	-13(8.6)	40.26	16.67	40.26	17.00	39.20	16.59	37.78	15.95	36.54	15.31	34.06	14.04
	-9.8(14.4)	-11(12.2)	42.21	16.94	41.68	16.92	39.20	15.67	37.78	15.07	36.54	14.46	34.06	13.29
	-9.5(14.9)	-10(14)	43.28	17.09	41.68	16.43	39.20	15.22	37.78	14.63	36.54	14.06	34.06	12.92
	-8.5(16.7)	-9.1(15.6)	44.17	17.18	41.68	15.99	39.20	14.81	37.78	14.24	36.54	13.69	34.06	12.59
	-7(19.4)	-7.6(18.3)	44.17	16.41	41.68	15.27	39.20	14.17	37.78	13.63	36.54	13.10	34.06	12.05
	-5(23)	-5.6(21.9)	44.17	15.42	41.68	14.37	39.20	13.34	37.78	12.83	36.54	15.15	34.06	11.37
	-3(26.6)	-3.7(25.3)	44.17	14.52	41.68	13.54	39.20	12.59	37.78	12.11	36.54	11.65	34.06	10.75
	0(32)	-0.7(30.7)	44.17	13.21	41.68	12.35	39.20	11.48	37.78	11.06	36.54	10.66	34.06	9.85
	3(37.4)	2.2(36)	44.17	12.07	41.68	11.30	39.20	10.53	37.78	10.14	36.54	9.78	34.06	9.04
	5(41)	4.1(39.4)	44.17	11.39	41.68	10.66	39.20	9.96	37.78	9.59	36.54	9.24	34.06	8.56
	7(44.6)	6(42.8)	44.17	10.77	41.68	10.09	39.20	9.41	37.78	9.08	36.54	8.76	34.06	8.12
9(48.2)	7.9(46.2)	44.17	10.18	41.68	9.54	39.20	8.91	37.78	8.60	36.54	8.31	34.06	7.70	
11(51.8)	9.8(49.6)	44.17	9.63	41.68	9.02	39.20	8.45	37.78	8.16	36.54	7.88	34.06	7.31	
13(55.4)	11.8(53.2)	44.17	9.10	41.68	8.54	39.20	7.99	37.78	7.74	36.54	7.46	34.06	6.95	
15(59)	13.7(56.7)	44.17	8.62	41.68	8.10	39.20	7.59	37.78	7.35	36.54	7.09	34.06	6.62	
60%	-19.8(-3.6)	-20(-4)	35.02	16.69	34.84	17.00	33.60	16.35	32.53	15.71	31.47	15.09	29.33	13.84
	-18.8(-1.8)	-19(-2.2)	35.56	16.80	35.56	17.11	33.60	16.00	32.53	15.38	31.47	14.76	29.33	13.54
	-16.7(1.9)	-17(1.4)	36.98	17.02	35.73	16.48	33.60	15.27	32.53	14.68	31.47	14.09	29.33	12.95
	-13.7(7.3)	-15(5)	37.87	16.83	35.73	15.66	33.60	14.52	32.53	13.97	31.47	13.41	29.33	12.33
	-11.8(10.8)	-13(8.6)	37.87	15.93	35.73	14.83	33.60	13.76	32.53	13.25	31.47	12.73	29.33	11.78
	-9.8(14.4)	-11(12.2)	37.87	15.05	35.73	14.02	33.60	13.03	32.53	12.53	31.47	12.05	29.33	11.12
	-9.5(14.9)	-10(14)	37.87	14.63	35.73	13.63	33.60	12.66	32.53	12.20	31.47	11.72	29.33	10.80
	-8.5(16.7)	-9.1(15.6)	37.87	14.24	35.73	13.29	33.60	12.35	32.53	11.89	31.47	11.43	29.33	10.55
	-7(19.4)	-7.6(18.3)	37.87	13.62	35.73	12.72	33.60	11.82	32.53	11.39	31.47	10.95	29.33	10.12
	-5(23)	-5.6(21.9)	37.87	12.83	35.73	11.98	33.60	11.15	32.53	10.75	31.47	10.35	29.33	9.57
	-3(26.6)	-3.7(25.3)	37.87	12.11	35.73	11.32	33.60	10.55	32.53	10.18	31.47	9.79	29.33	9.06
	0(32)	-0.7(30.7)	37.87	11.06	35.73	10.36	33.60	9.67	32.53	9.33	31.47	8.99	29.33	8.32
	3(37.4)	2.2(36)	37.87	10.14	35.73	9.52	33.60	8.89	32.53	8.58	31.47	8.29	29.33	7.68
	5(41)	4.1(39.4)	37.87	9.59	35.73	9.00	33.60	8.42	32.53	8.14	31.47	7.85	29.33	7.29
	7(44.6)	6(42.8)	37.87	9.08	35.73	8.53	33.60	7.97	32.53	7.72	31.47	7.46	29.33	6.93
9(48.2)	7.9(46.2)	37.87	8.60	35.73	8.08	33.60	7.57	32.53	7.33	31.47	7.07	29.33	6.60	
11(51.8)	9.8(49.6)	37.87	8.16	35.73	7.68	33.60	7.20	32.53	6.96	31.47	6.73	29.33	6.28	
13(55.4)	11.8(53.2)	37.87	7.72	35.73	7.28	33.60	6.84	32.53	6.62	31.47	6.39	29.33	5.97	
15(59)	13.7(56.7)	37.87	7.35	35.73	6.91	33.60	6.51	32.53	6.30	31.47	6.10	29.33	5.70	
50%	-19.8(-3.6)	-20(-4)	31.54	15.18	29.77	14.13	28.00	13.12	26.94	12.64	26.05	12.15	24.28	11.19
	-18.8(-1.8)	-19(-2.2)	31.54	14.85	29.77	13.84	28.00	12.86	26.94	12.37	26.05	11.89	24.28	10.97
	-16.7(1.9)	-17(1.4)	31.54	14.17	29.77	13.21	28.00	12.29	26.94	11.83	26.05	11.39	24.28	10.51
	-13.7(7.3)	-15(5)	31.54	13.49	29.77	12.59	28.00	11.70	26.94	11.28	26.05	10.86	24.28	10.03
	-11.8(10.8)	-13(8.6)	31.54	12.81	29.77	11.96	28.00	11.14	26.94	10.73	26.05	10.33	24.28	9.55
	-9.8(14.4)	-11(12.2)	31.54	12.13	29.77	11.34	28.00	10.57	26.94	10.18	26.05	9.81	24.28	9.08
	-9.5(14.9)	-10(14)	31.54	11.80	29.77	11.02	28.00	10.29	26.94	9.92	26.05	9.55	24.28	8.84
	-8.5(16.7)	-9.1(15.6)	31.54	11.50	29.77	10.77	28.00	10.03	26.94	9.68	26.05	9.33	24.28	8.64
	-7(19.4)	-7.6(18.3)	31.54	11.02	29.77	10.33	28.00	9.63	26.94	9.30	26.05	8.97	24.28	8.31
	-5(23)	-5.6(21.9)	31.54	10.40	29.77	9.76	28.00	9.11	26.94	8.80	26.05	8.49	24.28	7.86
	-3(26.6)	-3.7(25.3)	31.54	9.85	29.77	9.24	28.00	8.64	26.94	8.34	26.05	8.05	24.28	7.48
	0(32)	-0.7(30.7)	31.54	9.04	29.77	8.49	28.00	7.96	26.94	7.68	26.05	7.42	24.28	6.91
	3(37.4)	2.2(36)	31.54	8.32	29.77	7.83	28.00	7.33	26.94	7.09	26.05	6.85	24.28	6.39
	5(41)	4.1(39.4)	31.54	7.90	29.77	7.42	28.00	6.96	26.94	6.74	26.05	6.52	24.28	6.08
	7(44.6)	6(42.8)	31.54	7.50	29.77	7.06	28.00	6.63	26.94	6.41	26.05	6.21	24.28	5.81
9(48.2)	7.9(46.2)	31.54	7.11	29.77	6.71	28.00	6.30	26.94	6.12	26.05	5.92	24.28	5.53	
11(51.8)	9.8(49.6)	31.54	6.76	29.77	6.38	28.00	6.01	26.94	5.82	26.05	5.64	24.28	5.27	
13(55.4)	11.8(53.2)	31.54	6.43	29.77	6.06	28.00	5.71	26.94	5.55	26.05	5.37	24.28	5.03	
15(59)	13.7(56.7)	31.54	6.12	29.77	5.79	28.00	5.46	26.94	5.29	26.05	5.13	24.28	4.81	

**Heating capacity tables**

**MVD-V5X560W/V2GN1**

TC: Total Capacity (kW); PI: Power Input (kW) (Compressor + Outdoor fan motor)

Combination (%)	Outdoor temperature		Indoor temperature(°C(°F) DB)											
			16(60.8)		18(64.4)		20(68)		21(69.8)		22(71.6)		24(75.2)	
	°C(°F) DB	°C(°F) WB	TC	PI	TC	PI	TC	PI	TC	PI	TC	PI	TC	PI
130%	-19.8(-3.6)	-20(-4)	40.80	11.59	40.60	12.40	40.40	13.23	40.40	13.63	40.20	14.04	40.20	14.87
	-18.8(-1.8)	-19(-2.2)	41.40	11.84	41.20	12.65	41.20	13.46	41.00	13.87	41.00	14.25	40.80	15.06
	-16.7(1.9)	-17(1.4)	43.00	12.40	42.80	13.16	42.60	13.95	42.60	14.33	42.60	14.72	42.40	15.48
	-13.7(7.3)	-15(5)	44.80	12.97	44.60	13.72	44.40	14.46	44.40	14.82	44.20	15.21	44.20	15.95
	-11.8(10.8)	-13(8.6)	46.60	13.55	46.60	14.27	46.40	14.97	46.20	15.34	46.20	15.70	46.00	16.40
	-9.8(14.4)	-11(12.2)	48.80	14.14	48.60	14.82	48.40	15.51	48.40	15.85	48.40	16.19	48.20	16.87
	-9.5(14.9)	-10(14)	50.00	14.44	49.80	15.10	49.60	15.76	49.60	16.10	49.40	16.42	49.40	17.08
	-8.5(16.7)	-9.1(15.6)	51.00	14.70	50.80	15.34	50.80	16.00	50.60	16.32	50.60	16.63	50.40	17.30
	-7(19.4)	-7.6(18.3)	52.80	15.12	52.80	15.76	52.60	16.38	52.60	16.70	52.40	17.00	52.20	17.64
	-5(23)	-5.6(21.9)	55.60	15.70	55.40	16.29	55.20	16.89	55.20	17.19	55.00	17.46	55.00	18.06
	-3(26.6)	-3.7(25.3)	58.20	16.21	58.00	16.78	58.00	17.34	57.80	17.64	57.80	17.91	57.60	18.47
	0(32)	-0.7(30.7)	62.80	17.00	62.80	17.53	62.60	18.04	62.60	18.23	62.40	18.57	62.40	19.08
	3(37.4)	2.2(36)	67.79	17.70	67.60	18.19	67.40	18.68	67.40	18.91	67.40	19.17	67.20	19.64
	5(41)	4.1(39.4)	71.20	18.15	71.00	18.62	71.00	19.06	70.80	19.30	70.80	19.53	70.60	19.98
	7(44.6)	6(42.8)	74.80	18.57	74.60	19.00	74.60	19.45	74.40	19.66	74.40	19.87	71.40	19.08
9(48.2)	7.9(46.2)	78.60	18.96	78.40	19.38	78.40	19.79	78.20	20.00	76.60	19.58	71.40	17.93	
11(51.8)	9.8(49.6)	82.60	19.34	82.40	19.72	82.00	19.98	79.20	19.19	76.60	18.40	71.40	16.89	
13(55.4)	11.8(53.2)	87.00	19.70	86.80	20.09	82.00	18.72	79.20	17.98	76.60	17.27	71.40	15.85	
15(59)	13.7(56.7)	91.20	20.04	87.20	19.02	82.00	17.64	79.20	16.96	76.60	16.27	71.40	14.95	
120%	-19.8(-3.6)	-20(-4)	40.60	12.05	40.40	12.76	40.20	13.49	40.20	13.83	40.20	14.20	40.00	14.92
	-18.8(-1.8)	-19(-2.2)	41.20	12.27	41.00	12.98	41.00	13.69	40.80	14.03	40.80	14.40	40.60	15.10
	-16.7(1.9)	-17(1.4)	42.80	12.76	42.60	13.45	42.34	14.11	42.40	14.46	42.40	14.80	42.20	15.47
	-13.7(7.3)	-15(5)	44.60	13.27	44.40	13.91	44.20	14.56	44.20	14.90	44.20	15.23	44.00	15.87
	-11.8(10.8)	-13(8.6)	46.41	13.77	46.41	14.40	46.20	15.03	46.20	15.35	46.00	15.65	46.00	16.28
	-9.8(14.4)	-11(12.2)	48.60	14.30	48.40	14.88	48.40	15.49	48.20	15.79	48.20	16.08	48.00	16.68
	-9.5(14.9)	-10(14)	49.81	14.56	49.60	15.15	49.40	15.71	49.40	16.02	49.40	16.30	49.20	16.88
	-8.5(16.7)	-9.1(15.6)	50.80	14.78	50.60	15.35	50.60	15.91	50.40	16.20	50.40	16.50	50.20	17.07
	-7(19.4)	-7.6(18.3)	52.60	15.17	52.60	15.71	52.40	16.26	52.40	16.54	52.20	16.80	52.20	17.35
	-5(23)	-5.6(21.9)	55.40	15.65	55.20	16.18	55.00	16.70	55.00	16.97	55.00	17.23	54.81	17.73
	-3(26.6)	-3.7(25.3)	58.00	16.12	58.00	16.62	57.80	17.11	57.80	17.35	57.60	17.61	57.60	18.10
	0(32)	-0.7(30.7)	62.60	16.80	62.60	17.27	62.40	17.71	62.40	17.96	62.20	18.18	62.20	18.64
	3(37.4)	2.2(36)	67.60	17.43	67.40	17.86	67.40	18.28	67.20	18.50	67.20	18.70	65.80	18.60
	5(41)	4.1(39.4)	71.00	17.81	70.80	18.22	70.80	18.62	70.60	18.83	70.60	19.03	65.80	17.47
	7(44.6)	6(42.8)	74.60	18.18	74.60	18.56	74.40	18.95	73.21	18.68	70.80	17.92	65.80	16.44
9(48.2)	7.9(46.2)	78.41	18.54	78.20	18.91	75.60	18.28	73.21	17.56	70.80	16.84	65.80	15.47	
11(51.8)	9.8(49.6)	82.40	18.87	80.40	18.54	75.60	17.19	73.21	16.52	70.80	15.85	65.80	14.58	
13(55.4)	11.8(53.2)	85.40	18.68	80.40	17.39	75.60	16.12	73.21	15.51	70.80	14.90	65.80	13.71	
15(59)	13.7(56.7)	85.40	17.59	80.40	16.38	75.60	15.21	73.21	14.62	70.80	14.05	65.80	12.94	
110%	-19.8(-3.6)	-20(-4)	40.40	13.45	40.20	14.11	40.00	14.80	40.00	15.13	40.02	15.46	39.80	16.15
	-18.8(-1.8)	-19(-2.2)	41.00	13.66	40.80	14.32	40.80	14.98	40.80	15.32	40.60	15.65	40.60	16.31
	-16.7(1.9)	-17(1.4)	42.60	14.11	42.40	14.76	42.99	15.40	42.20	15.71	42.20	16.04	42.00	16.67
	-13.7(7.3)	-15(5)	44.40	14.59	44.21	15.21	44.00	15.81	44.00	16.13	44.00	16.44	43.80	17.04
	-11.8(10.8)	-13(8.6)	46.20	15.09	46.20	15.67	46.00	16.25	46.00	16.54	45.80	16.83	45.80	17.43
	-9.8(14.4)	-11(12.2)	48.40	15.57	48.20	16.13	48.20	16.69	48.00	16.98	48.00	17.25	48.00	17.81
	-9.5(14.9)	-10(14)	49.60	15.81	49.40	16.35	49.20	16.91	49.20	17.18	49.20	17.45	49.00	17.99
	-8.5(16.7)	-9.1(15.6)	50.60	16.02	50.40	16.56	50.40	17.10	50.20	17.37	50.20	17.64	50.20	18.08
	-7(19.4)	-7.6(18.3)	52.40	16.40	52.40	16.89	52.20	17.41	52.20	17.68	52.20	17.93	52.00	18.45
	-5(23)	-5.6(21.9)	55.20	16.85	55.00	17.35	54.80	17.83	54.80	18.08	54.80	18.33	54.60	18.83
	-3(26.6)	-3.7(25.3)	57.80	17.29	57.80	17.74	57.60	18.22	57.60	18.45	57.40	18.68	57.40	19.16
	0(32)	-0.7(30.7)	62.40	17.93	62.40	18.37	62.20	18.80	62.20	19.01	62.20	19.24	60.40	18.86
	3(37.4)	2.2(36)	67.40	18.53	67.20	18.93	67.20	19.32	67.00	19.51	64.80	18.72	60.40	17.16
	5(41)	4.1(39.4)	70.80	18.89	70.80	19.28	69.40	19.09	67.00	18.33	64.80	17.60	60.40	16.15
	7(44.6)	6(42.8)	74.40	19.24	73.80	19.36	69.40	17.93	67.00	17.22	64.80	16.54	60.40	15.19
9(48.2)	7.9(46.2)	78.20	19.55	73.80	18.20	69.40	16.87	67.00	16.21	64.80	15.57	60.40	14.32	
11(51.8)	9.8(49.6)	78.20	18.39	73.80	17.12	69.40	15.88	67.00	15.28	64.80	14.67	60.40	13.51	
13(55.4)	11.8(53.2)	78.20	17.25	73.80	16.06	69.40	14.92	67.00	14.36	64.80	13.80	60.40	12.72	
15(59)	13.7(56.7)	78.20	15.32	73.80	15.15	69.40	14.09	67.00	13.55	64.80	13.05	60.40	12.04	



**Heating capacity tables**

**MVD-V5X560W/V2GN1**

TC: Total Capacity (kW); PI: Power Input (kW) (Compressor + Outdoor fan motor)

Combination (%)	Outdoor temperature		Indoor temperature(°C(°F) DB)											
			16(60.8)		18(64.4)		20(68)		21(69.8)		22(71.6)		24(75.2)	
	°C(°F) DB	°C(°F) WB	TC	PI	TC	PI	TC	PI	TC	PI	TC	PI	TC	PI
100%	-19.8(-3.6)	-20(-4)	40.20	14.53	40.00	15.13	40.00	15.75	39.80	16.06	39.80	16.35	39.60	16.98
	-18.8(-1.8)	-19(-2.2)	40.80	14.71	40.80	15.32	40.60	15.92	40.60	16.23	40.40	16.54	40.40	17.14
	-16.7(1.9)	-17(1.4)	42.40	15.13	42.20	15.71	42.20	16.29	42.00	16.58	42.00	16.87	42.00	17.45
	-13.7(7.3)	-15(5)	44.20	15.56	44.00	16.13	43.80	16.69	43.80	16.98	43.80	17.25	43.60	17.80
	-11.8(10.8)	-13(8.6)	46.00	16.02	46.00	16.54	45.80	17.08	45.80	17.35	45.80	17.62	45.60	18.16
	-9.8(14.4)	-11(12.2)	48.20	16.46	48.00	16.98	48.00	17.47	48.00	17.74	47.80	17.99	47.80	18.49
	-9.5(14.9)	-10(14)	49.40	16.69	49.20	17.18	49.20	17.68	49.00	17.93	49.00	18.18	48.80	18.68
	-8.5(16.7)	-9.1(15.6)	50.40	16.87	50.20	17.37	50.20	17.85	50.20	18.10	50.00	18.35	50.00	18.82
	-7(19.4)	-7.6(18.3)	52.20	17.20	52.20	17.68	52.00	18.14	52.00	18.39	52.00	18.62	51.80	19.09
	-5(23)	-5.6(21.9)	55.00	17.64	54.80	18.08	54.80	18.53	54.60	18.74	54.60	18.97	54.40	19.43
	-3(26.6)	-3.7(25.3)	57.60	18.04	57.60	18.37	57.40	18.89	57.40	19.09	57.40	19.30	55.00	18.49
	0(32)	-0.7(30.7)	62.20	18.62	62.20	19.01	62.00	19.40	61.00	19.09	59.00	18.31	55.00	16.79
	3(37.4)	2.2(36)	67.20	19.16	67.00	19.51	63.00	18.06	61.00	17.35	59.00	16.67	55.00	15.29
	5(41)	4.1(39.4)	70.60	19.51	67.00	18.33	63.00	16.98	61.00	16.33	59.00	15.69	55.00	14.42
	7(44.6)	6(42.8)	71.00	18.51	67.00	17.22	63.00	15.98	61.00	15.38	59.00	14.78	55.00	13.59
9(48.2)	7.9(46.2)	71.00	17.39	67.00	16.21	63.00	15.05	61.00	14.30	59.00	13.92	55.00	12.83	
11(51.8)	9.8(49.6)	71.00	16.37	67.00	15.27	63.00	14.20	61.00	13.65	59.00	13.14	55.00	12.12	
13(55.4)	11.8(53.2)	71.00	15.38	67.00	14.36	63.00	13.37	61.00	12.87	59.00	12.39	55.00	11.44	
15(59)	13.7(56.7)	71.00	14.51	67.00	13.55	63.00	12.62	61.00	12.16	59.00	11.71	55.00	10.83	
90%	-19.8(-3.6)	-20(-4)	39.93	15.61	39.73	16.15	39.73	16.71	39.53	16.98	39.53	17.27	39.53	17.81
	-18.8(-1.8)	-19(-2.2)	40.53	15.77	40.53	16.33	40.33	16.87	40.33	17.14	40.33	17.41	40.13	17.95
	-16.7(1.9)	-17(1.4)	42.13	16.17	41.92	16.69	41.92	17.20	41.92	17.47	41.73	17.72	41.73	18.24
	-13.7(7.3)	-15(5)	43.92	16.56	43.72	17.06	43.72	17.56	43.52	17.81	43.52	18.05	43.52	18.55
	-11.8(10.8)	-13(8.6)	45.72	16.96	45.72	17.43	45.52	17.91	45.52	18.16	45.52	18.39	45.32	18.86
	-9.8(14.4)	-11(12.2)	47.92	17.35	47.92	17.81	47.71	18.26	47.71	18.49	47.71	18.74	47.51	19.20
	-9.5(14.9)	-10(14)	49.11	17.56	48.92	18.01	48.92	18.45	48.72	18.68	48.72	18.91	48.72	19.34
	-8.5(16.7)	-9.1(15.6)	50.11	17.74	50.11	18.18	49.91	18.62	49.91	18.82	49.91	19.05	49.31	19.24
	-7(19.4)	-7.6(18.3)	51.91	18.04	51.91	18.45	51.71	18.88	51.71	19.09	51.71	19.30	49.31	18.37
	-5(23)	-5.6(21.9)	54.70	18.43	54.51	18.82	54.51	19.22	54.30	19.43	52.91	18.82	49.31	17.27
	-3(26.6)	-3.7(25.3)	57.30	18.78	57.30	19.16	56.70	19.24	54.70	18.47	52.91	17.72	49.31	16.27
	0(32)	-0.7(30.7)	62.09	19.32	60.29	18.84	56.70	17.45	54.70	16.77	52.91	16.10	49.31	14.80
	3(37.4)	2.2(36)	63.89	18.41	60.29	17.14	56.70	15.90	54.70	15.29	52.91	14.69	49.31	13.53
	5(41)	4.1(39.4)	63.89	17.31	60.29	16.12	56.70	14.98	54.70	14.40	52.91	13.86	49.31	12.76
	7(44.6)	6(42.8)	63.89	16.27	60.29	15.19	56.70	14.11	54.70	13.59	52.91	13.07	49.31	12.06
9(48.2)	7.9(46.2)	63.89	15.34	60.29	14.30	56.70	13.30	54.70	12.82	52.91	12.35	49.31	11.39	
11(51.8)	9.8(49.6)	63.89	14.44	60.29	13.49	56.70	12.58	54.70	12.12	52.91	11.66	49.31	10.79	
13(55.4)	11.8(53.2)	63.89	13.59	60.29	12.72	56.70	11.85	54.70	11.43	52.91	11.02	49.31	10.19	
15(59)	13.7(56.7)	63.89	12.85	60.29	12.02	56.70	11.23	54.70	10.83	52.91	10.44	49.31	9.67	
80%	-19.8(-3.6)	-20(-4)	39.80	16.68	39.60	17.16	39.60	17.66	39.60	17.91	39.40	18.16	39.40	18.64
	-18.8(-1.8)	-19(-2.2)	40.40	16.83	40.40	17.33	40.20	17.81	40.20	18.05	40.20	18.28	40.00	18.78
	-16.7(1.9)	-17(1.4)	42.00	17.18	41.80	17.64	41.80	18.12	41.80	18.34	41.80	18.57	41.60	19.03
	-13.7(7.3)	-15(5)	43.80	17.54	43.60	17.97	43.60	18.43	43.60	18.64	43.40	18.86	43.40	19.32
	-11.8(10.8)	-13(8.6)	45.60	17.89	45.60	18.32	45.40	18.74	45.40	18.95	45.40	19.18	44.00	18.66
	-9.8(14.4)	-11(12.2)	47.80	18.24	47.80	18.66	47.60	19.07	47.60	19.26	47.20	19.22	44.00	17.62
	-9.5(14.9)	-10(14)	49.00	18.43	48.79	18.82	48.80	19.22	48.80	19.42	47.20	18.66	44.00	17.10
	-8.5(16.7)	-9.1(15.6)	50.00	18.59	46.47	18.99	49.80	19.36	48.80	18.93	47.20	18.16	44.00	16.64
	-7(19.4)	-7.6(18.3)	51.80	18.86	51.80	19.24	50.40	18.82	48.80	18.08	47.20	17.35	44.00	15.92
	-5(23)	-5.6(21.9)	54.60	19.20	53.60	19.09	50.40	17.68	48.80	17.00	47.20	16.31	44.00	14.98
	-3(26.6)	-3.7(25.3)	56.80	19.30	53.60	17.97	50.40	16.64	48.80	16.02	47.20	15.38	44.00	14.15
	0(32)	-0.7(30.7)	56.80	17.52	53.60	16.31	50.40	15.15	48.80	14.59	47.20	14.01	44.00	12.91
	3(37.4)	2.2(36)	56.80	15.96	53.60	14.88	50.40	13.84	48.80	13.32	47.20	12.82	44.00	11.83
	5(41)	4.1(39.4)	56.80	15.03	53.60	14.03	50.40	13.05	48.80	12.58	47.20	12.12	44.00	11.19
	7(44.6)	6(42.8)	56.80	14.15	53.60	13.24	50.40	12.33	48.80	11.89	47.20	11.46	44.00	10.58
9(48.2)	7.9(46.2)	56.80	13.36	53.60	12.49	50.40	11.64	48.80	11.23	47.20	10.83	44.00	10.02	
11(51.8)	9.8(49.6)	56.80	12.62	53.60	11.81	50.40	11.02	48.80	10.63	47.20	10.25	44.00	9.50	
13(55.4)	11.8(53.2)	56.80	11.89	53.60	11.14	50.40	10.42	48.80	10.04	47.20	9.69	44.00	8.99	
15(59)	13.7(56.7)	56.80	11.25	53.60	10.56	50.40	9.88	48.80	9.53	47.20	9.19	44.00	8.55	

**Heating capacity tables**

**MVD-V5X560W/V2GN1**

**TC:** Total Capacity (kW); **PI:** Power Input (kW) (Compressor + Outdoor fan motor)

Combination (%)	Outdoor temperature		Indoor temperature(°C(°F) DB)											
			16(60.8)		18(64.4)		20(68)		21(69.8)		22(71.6)		24(75.2)	
	°C(°F) DB	°C(°F) WB	TC	PI	TC	PI	TC	PI	TC	PI	TC	PI	TC	PI
70%	-19.8(-3.6)	-20(-4)	39.51	17.76	39.31	18.18	39.31	18.62	39.31	18.82	39.31	19.05	38.31	18.84
	-18.8(-1.8)	-19(-2.2)	40.11	17.91	40.11	18.32	39.91	18.74	39.91	18.95	39.91	19.18	38.31	18.45
	-16.7(1.9)	-17(1.4)	41.71	18.20	41.71	18.62	41.51	19.01	41.51	19.22	41.11	17.12	38.31	17.60
	-13.7(7.3)	-15(5)	43.50	18.51	43.30	18.91	43.30	19.30	42.50	19.01	41.11	18.24	38.31	16.73
	-11.8(10.8)	-13(8.6)	45.30	18.82	45.30	19.20	44.10	18.74	42.50	18.01	41.11	17.29	38.31	15.85
	-9.8(14.4)	-11(12.2)	47.49	19.13	46.89	19.11	44.10	17.70	42.50	17.02	41.11	16.33	38.31	15.00
	-9.5(14.9)	-10(14)	48.69	19.30	46.89	18.55	44.10	17.18	42.50	16.52	41.11	15.87	38.31	14.59
	-8.5(16.7)	-9.1(15.6)	49.69	19.40	46.89	18.05	44.10	16.73	42.50	16.08	41.11	15.46	38.31	14.22
	-7(19.4)	-7.6(18.3)	49.69	18.53	46.89	17.24	44.10	16.00	42.50	15.40	41.11	14.80	38.31	13.61
	-5(23)	-5.6(21.9)	49.69	17.41	46.89	16.23	44.10	15.07	42.50	14.49	41.11	17.11	38.31	12.85
	-3(26.6)	-3.7(25.3)	49.69	16.39	46.89	15.29	44.10	14.22	42.50	13.68	41.11	13.16	38.31	12.14
	0(32)	-0.7(30.7)	49.69	14.92	46.89	13.95	44.10	12.97	42.50	12.49	41.11	12.04	38.31	11.12
	3(37.4)	2.2(36)	49.69	13.63	46.89	12.76	44.10	11.89	42.50	11.45	41.11	11.04	38.31	10.21
	5(41)	4.1(39.4)	49.69	12.87	46.89	12.04	44.10	11.25	42.50	10.83	41.11	10.44	38.31	9.67
	7(44.6)	6(42.8)	49.69	12.16	46.89	11.39	44.10	10.63	42.50	10.25	41.11	9.90	38.31	9.17
9(48.2)	7.9(46.2)	49.69	11.50	46.89	10.77	44.10	10.07	42.50	9.71	41.11	9.38	38.31	8.70	
11(51.8)	9.8(49.6)	49.69	10.87	46.89	10.19	44.10	9.55	42.50	9.21	41.11	8.90	38.31	8.26	
13(55.4)	11.8(53.2)	49.69	10.27	46.89	9.65	44.10	9.03	42.50	8.74	41.11	8.43	38.31	7.84	
15(59)	13.7(56.7)	49.69	9.73	46.89	9.15	44.10	8.57	42.50	8.30	41.11	8.01	38.31	7.47	
60%	-19.8(-3.6)	-20(-4)	39.40	18.84	39.20	19.20	37.80	18.47	36.60	17.74	35.40	17.04	33.00	15.63
	-18.8(-1.8)	-19(-2.2)	40.00	18.97	40.00	19.32	37.80	18.07	36.60	17.37	35.40	16.66	33.00	15.29
	-16.7(1.9)	-17(1.4)	41.60	19.22	40.20	18.61	37.80	17.24	36.60	16.58	35.40	15.92	33.00	14.63
	-13.7(7.3)	-15(5)	42.60	19.01	40.20	17.68	37.80	16.39	36.60	15.77	35.40	15.15	33.00	13.92
	-11.8(10.8)	-13(8.6)	42.60	17.99	40.20	16.75	37.80	15.54	36.60	14.96	35.40	14.38	33.00	13.30
	-9.8(14.4)	-11(12.2)	42.60	17.00	40.20	15.83	37.80	14.71	36.60	14.15	35.40	13.61	33.00	12.55
	-9.5(14.9)	-10(14)	42.60	16.52	40.20	15.40	37.80	14.30	36.60	13.78	35.40	13.24	33.00	12.20
	-8.5(16.7)	-9.1(15.6)	42.60	16.08	40.20	15.00	37.80	13.95	36.60	13.43	35.40	12.91	33.00	11.91
	-7(19.4)	-7.6(18.3)	42.60	15.38	40.20	14.36	37.80	13.34	36.60	12.87	35.40	12.37	33.00	11.43
	-5(23)	-5.6(21.9)	42.60	14.48	40.20	13.53	37.80	12.60	36.60	12.14	35.40	11.68	33.00	10.81
	-3(26.6)	-3.7(25.3)	42.60	13.68	40.20	12.78	37.80	11.91	36.60	11.50	35.40	11.06	33.00	10.23
	0(32)	-0.7(30.7)	42.60	12.49	40.20	11.70	37.80	10.92	36.60	10.54	35.40	10.15	33.00	9.40
	3(37.4)	2.2(36)	42.60	11.46	40.20	10.75	37.80	10.04	36.60	9.69	35.40	9.36	33.00	8.67
	5(41)	4.1(39.4)	42.60	10.83	40.20	10.17	37.80	9.50	36.60	9.19	35.40	8.86	33.00	8.24
	7(44.6)	6(42.8)	42.60	10.25	40.20	9.63	37.80	9.01	36.60	8.72	35.40	8.43	33.00	7.82
9(48.2)	7.9(46.2)	42.60	9.71	40.20	9.13	37.80	8.55	36.60	8.28	35.40	7.99	33.00	7.45	
11(51.8)	9.8(49.6)	42.60	9.21	40.20	8.67	37.80	8.13	36.60	7.87	35.40	7.60	33.00	7.10	
13(55.4)	11.8(53.2)	42.60	8.72	40.20	8.22	37.80	7.72	36.60	7.47	35.40	7.22	33.00	6.74	
15(59)	13.7(56.7)	42.60	8.30	40.20	7.80	37.80	7.35	36.60	7.12	35.40	6.89	33.00	6.43	
50%	-19.8(-3.6)	-20(-4)	35.49	17.14	33.49	15.96	31.50	14.82	30.30	14.28	29.31	13.72	27.31	12.64
	-18.8(-1.8)	-19(-2.2)	35.49	16.77	33.49	15.63	31.50	14.53	30.30	13.97	29.31	13.43	27.31	12.39
	-16.7(1.9)	-17(1.4)	35.49	16.00	33.49	14.92	31.50	13.88	30.30	13.36	29.31	12.87	27.31	11.87
	-13.7(7.3)	-15(5)	35.49	15.23	33.49	14.21	31.50	13.22	30.30	12.74	29.31	12.26	27.31	11.33
	-11.8(10.8)	-13(8.6)	35.49	14.46	33.49	13.51	31.50	12.58	30.30	12.12	29.31	11.66	27.31	10.79
	-9.8(14.4)	-11(12.2)	35.49	13.70	33.49	12.80	31.50	11.93	30.30	11.50	29.31	11.08	27.31	10.25
	-9.5(14.9)	-10(14)	35.49	13.32	33.49	12.45	31.50	11.62	30.30	11.21	29.31	10.79	27.31	9.98
	-8.5(16.7)	-9.1(15.6)	35.49	12.99	33.49	12.16	31.50	11.33	30.30	10.94	29.31	10.54	27.31	9.75
	-7(19.4)	-7.6(18.3)	35.49	12.45	33.49	11.66	31.50	10.87	30.30	10.50	29.31	10.13	27.31	9.38
	-5(23)	-5.6(21.9)	35.49	11.75	33.49	11.02	31.50	10.29	30.30	9.94	29.31	9.59	27.31	8.88
	-3(26.6)	-3.7(25.3)	35.49	11.12	33.49	10.44	31.50	9.75	30.30	9.42	29.31	9.09	27.31	8.45
	0(32)	-0.7(30.7)	35.49	10.21	33.49	9.59	31.50	8.99	30.30	8.67	29.31	8.38	27.31	7.80
	3(37.4)	2.2(36)	35.49	9.40	33.49	8.84	31.50	8.28	30.30	8.01	29.31	7.74	27.31	7.22
	5(41)	4.1(39.4)	35.49	8.92	33.49	8.38	31.50	7.87	30.30	7.62	29.31	7.37	27.31	6.87
	7(44.6)	6(42.8)	35.49	8.47	33.49	7.97	31.50	7.49	30.30	7.24	29.31	7.01	27.31	6.56
9(48.2)	7.9(46.2)	35.49	8.03	33.49	7.57	31.50	7.12	30.30	6.91	29.31	6.68	27.31	6.25	
11(51.8)	9.8(49.6)	35.49	7.64	33.49	7.20	31.50	6.79	30.30	6.58	29.31	6.37	27.31	5.96	
13(55.4)	11.8(53.2)	35.49	7.26	33.49	6.85	31.50	6.45	30.30	6.27	29.31	6.06	27.31	5.69	
15(59)	13.7(56.7)	35.49	6.91	33.49	6.54	31.50	6.16	30.30	5.98	29.31	5.79	27.31	5.44	

**Heating capacity tables**

**MVD-V5X615W/V2GN1**

TC: Total Capacity (kW); PI: Power Input (kW) (Compressor + Outdoor fan motor)

Combination (%)	Outdoor temperature		Indoor temperature(°C(°F) DB)											
			16(60.8)		18(64.4)		20(68)		21(69.8)		22(71.6)		24(75.2)	
	°C(°F) DB	°C(°F) WB	TC	PI	TC	PI	TC	PI	TC	PI	TC	PI	TC	PI
130%	-19.8(-3.6)	-20(-4)	44.68	12.95	44.46	13.86	44.25	14.78	44.25	15.24	44.03	15.69	44.03	16.62
	-18.8(-1.8)	-19(-2.2)	45.35	13.24	45.12	14.14	45.12	15.04	44.90	15.50	44.90	15.92	44.68	16.83
	-16.7(1.9)	-17(1.4)	47.09	13.86	46.87	14.71	46.65	15.59	46.65	16.02	46.65	16.45	46.44	17.31
	-13.7(7.3)	-15(5)	49.06	14.50	48.85	15.33	48.63	16.16	48.63	16.57	48.41	17.00	48.41	17.83
	-11.8(10.8)	-13(8.6)	51.04	15.14	51.04	15.95	50.82	16.74	50.60	17.14	50.60	17.54	50.38	18.33
	-9.8(14.4)	-11(12.2)	53.45	15.81	53.23	16.57	53.01	17.33	53.01	17.71	53.01	18.09	52.79	18.85
	-9.5(14.9)	-10(14)	54.76	16.14	54.54	16.88	54.32	17.62	54.32	18.00	54.10	18.35	54.10	19.09
	-8.5(16.7)	-9.1(15.6)	55.85	16.43	55.64	17.14	55.64	17.88	55.42	18.23	55.42	18.59	55.20	19.33
	-7(19.4)	-7.6(18.3)	57.83	16.90	57.83	17.62	57.61	18.31	57.61	18.66	57.39	19.00	57.17	19.71
	-5(23)	-5.6(21.9)	60.89	17.54	60.67	18.21	60.45	18.88	60.45	19.21	60.24	19.52	60.24	20.19
	-3(26.6)	-3.7(25.3)	63.74	18.12	63.52	18.76	63.52	19.38	63.30	19.71	63.30	20.02	63.08	20.64
	0(32)	-0.7(30.7)	68.78	19.00	68.78	19.59	68.56	20.16	68.56	20.38	68.34	20.76	68.34	21.33
	3(37.4)	2.2(36)	74.25	19.78	74.04	20.33	73.82	20.88	73.82	21.14	73.82	21.43	73.60	21.95
	5(41)	4.1(39.4)	77.98	20.28	77.76	20.81	77.76	21.31	77.54	21.57	77.54	21.83	77.32	22.33
	7(44.6)	6(42.8)	81.92	20.76	81.70	21.23	81.70	21.73	81.48	21.97	81.48	22.21	78.20	21.33
9(48.2)	7.9(46.2)	86.08	21.19	85.86	21.66	85.86	22.11	85.65	22.35	83.89	21.88	78.20	20.04	
11(51.8)	9.8(49.6)	90.46	21.61	90.25	22.04	89.81	22.33	86.74	21.45	83.89	20.57	78.20	18.88	
13(55.4)	11.8(53.2)	95.28	22.02	95.06	22.45	89.81	20.93	86.74	20.09	83.89	19.31	78.20	17.71	
15(59)	13.7(56.7)	99.88	22.40	95.50	21.26	89.81	19.71	86.74	18.95	83.89	18.19	78.20	16.71	
120%	-19.8(-3.6)	-20(-4)	44.47	13.47	44.25	14.26	44.03	15.07	44.03	15.46	44.03	15.87	43.81	16.68
	-18.8(-1.8)	-19(-2.2)	45.13	13.72	44.91	14.51	44.91	15.30	44.69	15.69	44.69	16.09	44.47	16.88
	-16.7(1.9)	-17(1.4)	46.88	14.26	46.66	15.03	46.37	15.77	46.44	16.16	46.44	16.54	46.22	17.29
	-13.7(7.3)	-15(5)	48.85	14.83	48.63	15.55	48.41	16.27	48.41	16.66	48.41	17.02	48.19	17.74
	-11.8(10.8)	-13(8.6)	50.82	15.39	50.82	16.09	50.60	16.79	50.60	17.15	50.38	17.49	50.38	18.19
	-9.8(14.4)	-11(12.2)	53.23	15.98	53.01	16.63	53.01	17.31	52.79	17.65	52.79	17.97	52.58	18.65
	-9.5(14.9)	-10(14)	54.55	16.27	54.33	16.93	54.11	17.56	54.11	17.90	54.11	18.22	53.89	18.87
	-8.5(16.7)	-9.1(15.6)	55.64	16.52	55.42	17.15	55.42	17.79	55.20	18.10	55.20	18.44	54.98	19.07
	-7(19.4)	-7.6(18.3)	57.61	16.95	57.61	17.56	57.39	18.17	57.39	18.49	57.17	18.78	57.17	19.39
	-5(23)	-5.6(21.9)	60.68	17.49	60.46	18.08	60.24	18.67	60.24	18.96	60.24	19.26	60.02	19.82
	-3(26.6)	-3.7(25.3)	63.53	18.01	63.53	18.58	63.31	19.12	63.31	19.39	63.09	19.69	63.09	20.23
	0(32)	-0.7(30.7)	68.56	18.78	68.56	19.30	68.34	19.80	68.34	20.07	68.12	20.32	68.12	20.84
	3(37.4)	2.2(36)	74.04	19.48	73.82	19.96	73.82	20.43	73.60	20.68	73.60	20.91	72.07	20.79
	5(41)	4.1(39.4)	77.76	19.91	77.54	20.36	77.54	20.81	77.32	21.04	77.32	21.27	72.07	19.53
	7(44.6)	6(42.8)	81.71	20.32	81.71	20.75	81.49	21.18	80.18	20.88	77.54	20.02	72.07	18.37
9(48.2)	7.9(46.2)	85.87	20.73	85.65	21.13	82.80	20.43	80.18	19.62	77.54	18.83	72.07	17.29	
11(51.8)	9.8(49.6)	90.25	21.09	88.06	20.73	82.80	19.21	80.18	18.46	77.54	17.72	72.07	16.30	
13(55.4)	11.8(53.2)	93.53	20.88	88.06	19.44	82.80	18.01	80.18	17.34	77.54	16.66	72.07	15.32	
15(59)	13.7(56.7)	93.53	19.66	88.06	18.31	82.80	17.00	80.18	16.34	77.54	15.71	72.07	14.46	
110%	-19.8(-3.6)	-20(-4)	44.25	15.03	44.03	15.77	43.81	16.54	43.81	16.91	43.83	17.28	43.59	18.05
	-18.8(-1.8)	-19(-2.2)	44.91	15.26	44.69	16.00	44.69	16.75	44.69	17.12	44.47	17.49	44.47	18.23
	-16.7(1.9)	-17(1.4)	46.66	15.77	46.44	16.49	47.09	17.21	46.22	17.56	46.22	17.93	46.00	18.63
	-13.7(7.3)	-15(5)	48.63	16.31	48.42	17.00	48.19	17.67	48.19	18.02	48.19	18.37	47.97	19.04
	-11.8(10.8)	-13(8.6)	50.60	16.86	50.60	17.51	50.38	18.16	50.38	18.49	50.16	18.81	50.16	19.48
	-9.8(14.4)	-11(12.2)	53.01	17.40	52.79	18.02	52.79	18.65	52.57	18.97	52.57	19.28	52.57	19.90
	-9.5(14.9)	-10(14)	54.32	17.67	54.10	18.28	53.88	18.90	53.88	19.21	53.88	19.51	53.67	20.11
	-8.5(16.7)	-9.1(15.6)	55.42	17.91	55.20	18.51	55.20	19.11	54.98	19.42	54.98	19.72	54.98	17.98
	-7(19.4)	-7.6(18.3)	57.39	18.33	57.39	18.88	57.18	19.46	57.18	19.76	57.18	20.04	56.95	20.62
	-5(23)	-5.6(21.9)	60.46	18.83	60.24	19.39	60.02	19.92	60.02	20.20	60.02	20.48	59.80	21.04
	-3(26.6)	-3.7(25.3)	63.31	19.32	63.31	19.83	63.09	20.37	63.09	20.62	62.87	20.88	62.87	21.41
	0(32)	-0.7(30.7)	68.34	20.04	68.34	20.53	68.13	21.01	68.13	21.25	68.13	21.50	66.15	21.08
	3(37.4)	2.2(36)	73.82	20.71	73.60	21.15	73.60	21.59	73.38	21.80	70.97	20.92	66.15	19.18
	5(41)	4.1(39.4)	77.55	21.11	77.55	21.55	76.01	21.34	73.38	20.48	70.97	19.67	66.15	18.05
	7(44.6)	6(42.8)	81.48	21.50	80.83	21.64	76.01	20.04	73.38	19.25	70.97	18.49	66.15	16.98
9(48.2)	7.9(46.2)	85.65	21.85	80.83	20.34	76.01	18.86	73.38	18.11	70.97	17.40	66.15	16.00	
11(51.8)	9.8(49.6)	85.65	20.55	80.83	19.14	76.01	17.74	73.38	17.07	70.97	16.40	66.15	15.10	
13(55.4)	11.8(53.2)	85.65	19.28	80.83	17.95	76.01	16.68	73.38	16.05	70.97	15.43	66.15	14.22	
15(59)	13.7(56.7)	85.65	17.12	80.83	16.93	76.01	15.75	73.38	15.15	70.97	14.59	66.15	13.45	

**Heating capacity tables**

**MVD-V5X615W/V2GN1**

**TC:** Total Capacity (kW); **PI:** Power Input (kW) (Compressor + Outdoor fan motor)

Combination (%)	Outdoor temperature		Indoor temperature(°C(°F) DB)											
			16(60.8)		18(64.4)		20(68)		21(69.8)		22(71.6)		24(75.2)	
	°C(°F) DB	°C(°F) WB	TC	PI	TC	PI	TC	PI	TC	PI	TC	PI	TC	PI
100%	-19.8(-3.6)	-20(-4)	44.03	16.24	43.81	16.91	43.81	17.60	43.59	17.95	43.59	18.28	43.37	18.97
	-18.8(-1.8)	-19(-2.2)	44.68	16.45	44.68	17.12	44.46	17.79	44.46	18.14	44.25	18.49	44.25	19.16
	-16.7(1.9)	-17(1.4)	46.44	16.91	46.22	17.56	46.22	18.21	46.00	18.53	46.00	18.86	46.00	19.51
	-13.7(7.3)	-15(5)	48.41	17.40	48.19	18.02	47.97	18.65	47.97	18.97	47.97	19.27	47.75	19.90
	-11.8(10.8)	-13(8.6)	50.38	17.91	50.38	18.49	50.16	19.09	50.16	19.39	50.16	19.69	49.94	20.30
	-9.8(14.4)	-11(12.2)	52.79	18.39	52.57	18.97	52.57	19.53	52.57	19.83	52.35	20.11	52.35	20.67
	-9.5(14.9)	-10(14)	54.10	18.65	53.89	19.20	53.89	19.76	53.67	20.04	53.67	20.32	53.45	20.87
	-8.5(16.7)	-9.1(15.6)	55.20	18.86	54.98	19.41	54.98	19.95	54.98	20.23	54.77	20.51	54.77	21.04
	-7(19.4)	-7.6(18.3)	57.17	19.23	57.17	19.76	56.95	20.27	56.95	20.55	56.95	20.81	56.73	21.34
	-5(23)	-5.6(21.9)	60.24	19.72	60.02	20.20	60.02	20.71	59.80	20.94	59.80	21.20	59.58	21.71
	-3(26.6)	-3.7(25.3)	63.09	20.16	63.09	18.30	62.87	21.11	62.87	21.34	62.87	21.57	60.24	20.67
	0(32)	-0.7(30.7)	68.12	20.81	68.12	21.25	67.90	21.69	66.81	21.34	64.62	20.46	60.24	18.76
	3(37.4)	2.2(36)	73.60	21.41	73.38	21.80	69.00	20.18	66.81	19.39	64.62	18.63	60.24	17.09
	5(41)	4.1(39.4)	77.32	21.80	73.38	20.48	69.00	18.97	66.81	18.25	64.62	17.53	60.24	16.12
	7(44.6)	6(42.8)	77.76	20.69	73.38	19.25	69.00	17.86	66.81	17.19	64.62	16.52	60.24	15.19
9(48.2)	7.9(46.2)	77.76	19.44	73.38	18.12	69.00	16.82	66.81	15.98	64.62	15.56	60.24	14.33	
11(51.8)	9.8(49.6)	77.76	18.30	73.38	17.07	69.00	15.87	66.81	15.26	64.62	14.68	60.24	13.55	
13(55.4)	11.8(53.2)	77.76	17.19	73.38	16.05	69.00	14.94	66.81	14.38	64.62	13.85	60.24	12.78	
15(59)	13.7(56.7)	77.76	16.21	73.38	15.15	69.00	14.10	66.81	13.59	64.62	13.08	60.24	12.11	
90%	-19.8(-3.6)	-20(-4)	43.73	17.44	43.51	18.04	43.51	18.67	43.30	18.97	43.30	19.30	43.30	19.90
	-18.8(-1.8)	-19(-2.2)	44.39	17.63	44.39	18.25	44.17	18.86	44.17	19.16	44.17	19.46	43.95	20.06
	-16.7(1.9)	-17(1.4)	46.14	18.07	45.92	18.65	45.92	19.23	45.92	19.53	45.70	19.81	45.70	20.39
	-13.7(7.3)	-15(5)	48.10	18.51	47.89	19.07	47.89	19.62	47.67	19.90	47.67	20.18	47.67	20.74
	-11.8(10.8)	-13(8.6)	50.07	18.95	50.07	19.48	49.85	20.02	49.85	20.30	49.85	20.55	49.64	21.08
	-9.8(14.4)	-11(12.2)	52.48	19.39	52.48	19.90	52.26	20.41	52.26	20.67	52.26	20.94	52.04	21.45
	-9.5(14.9)	-10(14)	53.79	19.62	53.57	20.13	53.57	20.62	53.36	20.87	53.36	21.13	53.36	21.62
	-8.5(16.7)	-9.1(15.6)	54.88	19.83	54.88	20.32	54.67	20.81	54.67	21.04	54.67	21.29	54.01	21.50
	-7(19.4)	-7.6(18.3)	56.85	20.16	56.85	20.62	56.64	21.11	56.64	21.34	56.64	21.57	54.01	20.53
	-5(23)	-5.6(21.9)	59.91	20.60	59.70	21.04	59.70	21.48	59.47	21.71	57.95	21.04	54.01	19.30
	-3(26.6)	-3.7(25.3)	62.76	20.99	62.76	21.41	62.10	21.50	59.91	20.64	57.95	19.81	54.01	18.18
	0(32)	-0.7(30.7)	68.01	21.59	66.04	21.06	62.10	19.51	59.91	18.74	57.95	18.00	54.01	16.54
	3(37.4)	2.2(36)	69.97	20.57	66.04	19.16	62.10	17.77	59.91	17.09	57.95	16.42	54.01	15.12
	5(41)	4.1(39.4)	69.97	19.34	66.04	18.02	62.10	16.75	59.91	16.10	57.95	15.49	54.01	14.26
	7(44.6)	6(42.8)	69.97	18.18	66.04	16.98	62.10	15.77	59.91	15.19	57.95	14.61	54.01	13.48
9(48.2)	7.9(46.2)	69.97	17.14	66.04	15.98	62.10	14.87	59.91	14.33	57.95	13.80	54.01	12.73	
11(51.8)	9.8(49.6)	69.97	16.14	66.04	15.08	62.10	14.06	59.91	13.55	57.95	13.04	54.01	12.06	
13(55.4)	11.8(53.2)	69.97	15.19	66.04	14.22	62.10	13.24	59.91	12.78	57.95	12.32	54.01	11.39	
15(59)	13.7(56.7)	69.97	14.36	66.04	13.43	62.10	12.55	59.91	12.11	57.95	11.67	54.01	10.81	
80%	-19.8(-3.6)	-20(-4)	43.59	18.65	43.37	19.18	43.37	19.74	43.37	20.02	43.15	20.30	43.15	20.83
	-18.8(-1.8)	-19(-2.2)	44.25	18.81	44.25	19.37	44.03	19.90	44.03	20.18	44.03	20.43	43.81	20.99
	-16.7(1.9)	-17(1.4)	46.00	19.20	45.78	19.72	45.78	20.25	45.78	20.50	45.78	20.76	45.56	21.27
	-13.7(7.3)	-15(5)	47.97	19.60	47.75	20.09	47.75	20.60	47.75	20.83	47.53	21.08	47.53	21.59
	-11.8(10.8)	-13(8.6)	49.94	19.99	49.94	20.48	49.72	20.94	49.72	21.18	49.72	21.43	48.19	20.85
	-9.8(14.4)	-11(12.2)	52.35	20.39	52.35	20.85	52.13	21.31	52.13	21.52	51.69	21.48	48.19	19.69
	-9.5(14.9)	-10(14)	53.67	20.60	53.44	21.04	53.45	21.48	53.45	21.71	51.69	20.85	48.19	19.11
	-8.5(16.7)	-9.1(15.6)	54.76	20.78	50.90	21.22	54.54	21.64	53.45	21.15	51.69	20.30	48.19	18.60
	-7(19.4)	-7.6(18.3)	56.73	21.08	56.73	21.50	55.20	21.04	53.45	20.20	51.69	19.39	48.19	17.79
	-5(23)	-5.6(21.9)	59.80	21.45	58.71	21.34	55.20	19.76	53.45	19.00	51.69	18.23	48.19	16.75
	-3(26.6)	-3.7(25.3)	62.21	21.57	58.71	20.09	55.20	18.60	53.45	17.91	51.69	17.19	48.19	15.82
	0(32)	-0.7(30.7)	62.21	19.58	58.71	18.23	55.20	16.93	53.45	16.31	51.69	15.66	48.19	14.43
	3(37.4)	2.2(36)	62.21	17.84	58.71	16.63	55.20	15.47	53.45	14.89	51.69	14.33	48.19	13.22
	5(41)	4.1(39.4)	62.21	16.79	58.71	15.68	55.20	14.59	53.45	14.06	51.69	13.55	48.19	12.50
	7(44.6)	6(42.8)	62.21	15.82	58.71	14.80	55.20	13.78	53.45	13.29	51.69	12.80	48.19	11.83
9(48.2)	7.9(46.2)	62.21	14.94	58.71	13.96	55.20	13.01	53.45	12.55	51.69	12.11	48.19	11.20	
11(51.8)	9.8(49.6)	62.21	14.10	58.71	13.20	55.20	12.32	53.45	11.88	51.69	11.46	48.19	10.62	
13(55.4)	11.8(53.2)	62.21	13.29	58.71	12.45	55.20	11.64	53.45	11.23	51.69	10.83	48.19	10.04	
15(59)	13.7(56.7)	62.21	12.57	58.71	11.81	55.20	11.04	53.45	10.65	51.69	10.28	48.19	9.56	

**Heating capacity tables**

**MVD-V5X615W/V2GN1**

TC: Total Capacity (kW); PI: Power Input (kW) (Compressor + Outdoor fan motor)

Combination (%)	Outdoor temperature		Indoor temperature(°C(°F) DB)											
			16(60.8)		18(64.4)		20(68)		21(69.8)		22(71.6)		24(75.2)	
	°C(°F) DB	°C(°F) WB	TC	PI	TC	PI	TC	PI	TC	PI	TC	PI	TC	PI
70%	-19.8(-3.6)	-20(-4)	43.27	19.85	43.05	20.32	43.05	20.81	43.05	21.04	43.05	21.29	41.96	21.06
	-18.8(-1.8)	-19(-2.2)	43.93	20.02	43.93	20.48	43.71	20.94	43.71	21.18	43.71	21.43	41.96	20.62
	-16.7(1.9)	-17(1.4)	45.68	20.34	45.68	20.81	45.46	21.25	45.46	21.48	45.02	19.13	41.96	19.67
	-13.7(7.3)	-15(5)	47.64	20.69	47.43	21.13	47.43	21.57	46.55	21.25	45.02	20.39	41.96	18.69
	-11.8(10.8)	-13(8.6)	49.61	21.04	49.61	21.45	48.30	20.94	46.55	20.13	45.02	19.32	41.96	17.72
	-9.8(14.4)	-11(12.2)	52.01	21.38	51.36	21.36	48.30	19.78	46.55	19.02	45.02	18.25	41.96	16.77
	-9.5(14.9)	-10(14)	53.33	21.57	51.36	20.74	48.30	19.20	46.55	18.46	45.02	17.74	41.96	16.30
	-8.5(16.7)	-9.1(15.6)	54.42	21.69	51.36	20.18	48.30	18.69	46.55	17.98	45.02	17.28	41.96	15.89
	-7(19.4)	-7.6(18.3)	54.42	20.71	51.36	19.27	48.30	17.88	46.55	17.21	45.02	16.54	41.96	15.22
	-5(23)	-5.6(21.9)	54.42	19.46	51.36	18.14	48.30	16.84	46.55	16.19	45.02	19.12	41.96	14.36
	-3(26.6)	-3.7(25.3)	54.42	18.32	51.36	17.09	48.30	15.89	46.55	15.28	45.02	14.70	41.96	13.57
	0(32)	-0.7(30.7)	54.42	16.68	51.36	15.59	48.30	14.50	46.55	13.96	45.02	13.45	41.96	12.43
	3(37.4)	2.2(36)	54.42	15.24	51.36	14.26	48.30	13.29	46.55	12.80	45.02	12.34	41.96	11.41
	5(41)	4.1(39.4)	54.42	14.38	51.36	13.45	48.30	12.57	46.55	12.11	45.02	11.67	41.96	10.81
	7(44.6)	6(42.8)	54.42	13.59	51.36	12.73	48.30	11.88	46.55	11.46	45.02	11.06	41.96	10.25
9(48.2)	7.9(46.2)	54.42	12.85	51.36	12.04	48.30	11.25	46.55	10.86	45.02	10.48	41.96	9.72	
11(51.8)	9.8(49.6)	54.42	12.15	51.36	11.39	48.30	10.67	46.55	10.30	45.02	9.95	41.96	9.23	
13(55.4)	11.8(53.2)	54.42	11.48	51.36	10.78	48.30	10.09	46.55	9.76	45.02	9.42	41.96	8.77	
15(59)	13.7(56.7)	54.42	10.88	51.36	10.23	48.30	9.58	46.55	9.28	45.02	8.95	41.96	8.35	
60%	-19.8(-3.6)	-20(-4)	43.15	21.06	42.93	21.45	41.40	20.64	40.09	19.83	38.77	19.04	36.14	17.46
	-18.8(-1.8)	-19(-2.2)	43.81	21.20	43.81	21.59	41.40	20.20	40.09	19.41	38.77	18.62	36.14	17.09
	-16.7(1.9)	-17(1.4)	45.56	21.48	44.03	20.80	41.40	19.27	40.09	18.53	38.77	17.79	36.14	16.35
	-13.7(7.3)	-15(5)	46.66	21.25	44.03	19.76	41.40	18.32	40.09	17.63	38.77	16.93	36.14	15.56
	-11.8(10.8)	-13(8.6)	46.66	20.11	44.03	18.72	41.40	17.37	40.09	16.72	38.77	16.07	36.14	14.87
	-9.8(14.4)	-11(12.2)	46.66	19.00	44.03	17.70	41.40	16.44	40.09	15.82	38.77	15.21	36.14	14.03
	-9.5(14.9)	-10(14)	46.66	18.46	44.03	17.21	41.40	15.98	40.09	15.40	38.77	14.80	36.14	13.64
	-8.5(16.7)	-9.1(15.6)	46.66	17.97	44.03	16.77	41.40	15.59	40.09	15.01	38.77	14.43	36.14	13.31
	-7(19.4)	-7.6(18.3)	46.66	17.19	44.03	16.05	41.40	14.91	40.09	14.38	38.77	13.82	36.14	12.78
	-5(23)	-5.6(21.9)	46.66	16.19	44.03	15.12	41.40	14.08	40.09	13.57	38.77	13.06	36.14	12.08
	-3(26.6)	-3.7(25.3)	46.66	15.28	44.03	14.29	41.40	13.31	40.09	12.85	38.77	12.36	36.14	11.43
	0(32)	-0.7(30.7)	46.66	13.96	44.03	13.08	41.40	12.20	40.09	11.78	38.77	11.34	36.14	10.51
	3(37.4)	2.2(36)	46.66	12.80	44.03	12.01	41.40	11.23	40.09	10.83	38.77	10.46	36.14	9.69
	5(41)	4.1(39.4)	46.66	12.11	44.03	11.36	41.40	10.62	40.09	10.27	38.77	9.90	36.14	9.21
	7(44.6)	6(42.8)	46.66	11.46	44.03	10.76	41.40	10.07	40.09	9.74	38.77	9.42	36.14	8.74
9(48.2)	7.9(46.2)	46.66	10.85	44.03	10.20	41.40	9.56	40.09	9.25	38.77	8.93	36.14	8.33	
11(51.8)	9.8(49.6)	46.66	10.30	44.03	9.69	41.40	9.09	40.09	8.79	38.77	8.49	36.14	7.93	
13(55.4)	11.8(53.2)	46.66	9.74	44.03	9.18	41.40	8.63	40.09	8.35	38.77	8.07	36.14	7.54	
15(59)	13.7(56.7)	46.66	9.28	44.03	8.72	41.40	8.21	40.09	7.96	38.77	7.70	36.14	7.19	
50%	-19.8(-3.6)	-20(-4)	38.87	19.16	36.68	17.84	34.50	16.56	33.19	15.96	32.10	15.33	29.91	14.12
	-18.8(-1.8)	-19(-2.2)	38.87	18.74	36.68	17.46	34.50	16.24	33.19	15.61	32.10	15.01	29.91	13.85
	-16.7(1.9)	-17(1.4)	38.87	17.88	36.68	16.68	34.50	15.52	33.19	14.94	32.10	14.38	29.91	13.27
	-13.7(7.3)	-15(5)	38.87	17.02	36.68	15.89	34.50	14.77	33.19	14.24	32.10	13.71	29.91	12.66
	-11.8(10.8)	-13(8.6)	38.87	16.17	36.68	15.10	34.50	14.06	33.19	13.54	32.10	13.03	29.91	12.06
	-9.8(14.4)	-11(12.2)	38.87	15.31	36.68	14.31	34.50	13.34	33.19	12.85	32.10	12.38	29.91	11.46
	-9.5(14.9)	-10(14)	38.87	14.89	36.68	13.92	34.50	12.99	33.19	12.52	32.10	12.06	29.91	11.16
	-8.5(16.7)	-9.1(15.6)	38.87	14.52	36.68	13.59	34.50	12.66	33.19	12.22	32.10	11.78	29.91	10.90
	-7(19.4)	-7.6(18.3)	38.87	13.92	36.68	13.03	34.50	12.15	33.19	11.74	32.10	11.32	29.91	10.48
	-5(23)	-5.6(21.9)	38.87	13.13	36.68	12.32	34.50	11.50	33.19	11.11	32.10	10.72	29.91	9.93
	-3(26.6)	-3.7(25.3)	38.87	12.43	36.68	11.67	34.50	10.90	33.19	10.53	32.10	10.16	29.91	9.44
	0(32)	-0.7(30.7)	38.87	11.41	36.68	10.72	34.50	10.04	33.19	9.69	32.10	9.37	29.91	8.72
	3(37.4)	2.2(36)	38.87	10.51	36.68	9.88	34.50	9.25	33.19	8.95	32.10	8.65	29.91	8.07
	5(41)	4.1(39.4)	38.87	9.97	36.68	9.37	34.50	8.79	33.19	8.51	32.10	8.23	29.91	7.68
	7(44.6)	6(42.8)	38.87	9.46	36.68	8.91	34.50	8.37	33.19	8.09	32.10	7.84	29.91	7.33
9(48.2)	7.9(46.2)	38.87	8.98	36.68	8.47	34.50	7.95	33.19	7.72	32.10	7.47	29.91	6.98	
11(51.8)	9.8(49.6)	38.87	8.54	36.68	8.05	34.50	7.58	33.19	7.35	32.10	7.12	29.91	6.66	
13(55.4)	11.8(53.2)	38.87	8.12	36.68	7.65	34.50	7.21	33.19	7.00	32.10	6.77	29.91	6.35	
15(59)	13.7(56.7)	38.87	7.72	36.68	7.31	34.50	6.89	33.19	6.68	32.10	6.47	29.91	6.08	

### 8. Operation limits

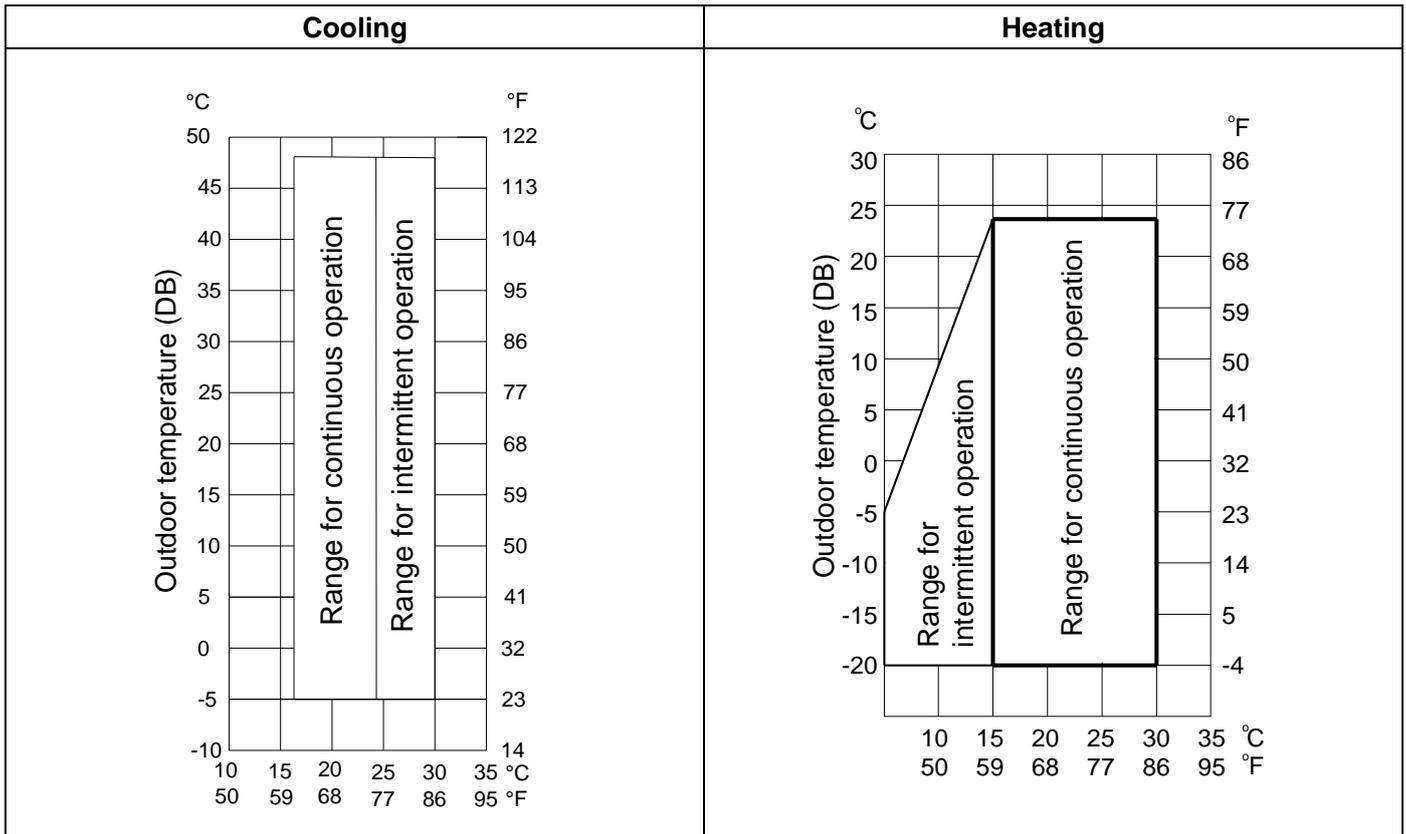

**Note:**

1. These figures assume the following operating conditions:  
 Equivalent piping length: 295-1/4inch (7.5m)  
 Level difference: 0
2. If the system is running in cooling mode, when the ambient temperature is lower than -5°C (23°F) or higher than 48°C(118.4°F), the unit will stop for protection control.

## 9. Sound levels

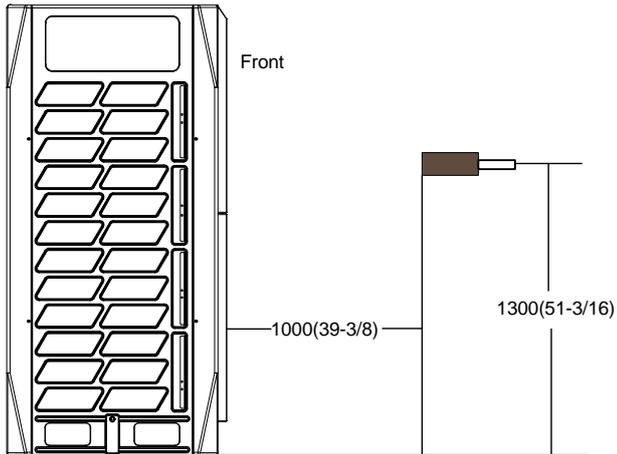

### Notes:

- Data is valid at free field condition
- Data is valid at nominal operating condition
- Sound level will vary depending on a range of factors such as the construction (acoustic absorption coefficient) of particular room in which the equipment is installed
- Sound level can be increased in static pressure mode or used air guide.

### Sound pressure level

Model	Sound pressure level dB(A)
MVD-V5X252W/V2GN1	58
MVD-V5X280W/V2GN1	59
MVD-V5X335W/V2GN1	60
MVD-V5X400W/V2GN1	62
MVD-V5X450W/V2GN1	62
MVD-V5X500W/V2GN1	63
MVD-V5X560W/V2GN1	63
MVD-V5X615W/V2GN1	63

## 10. Accessories

### 10.1 Standard accessories

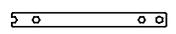
Name	Shape	Quantity	Function
Installation manual of outdoor unit		1	/
Operation manual of outdoor unit		1	/
Operation manual of indoor unit		2	/
Toggling flathead screw	-	1	For toggling of indoor and outdoor units
90° mouting elbow		1	For connecting pipes
Seal plug		8	Be used in cleaning pipe
Connection pipe		3	For connecting pipes
Matched resistance		2	Enhance stability of communication
Wrench		1	Dismantle screws of side plate
Accessory bag	-	1	/

### 10.2 Optional accessories

Branch joint of outdoor & indoor unit

Optional accessories	Model name	Packing Size in.(mm)	Net/gross Weight (lbs.(kg))	Function
Branch joint of outdoor side	FQZHW-02N1D	10-1/16x6x7-5/16 (255x150x185)	3.3/2.6 (1.5/1.2)	Distribute the refrigerant to indoor units and balance the resistance between each outdoor unit.
	FQZHW-03N1D	13-9/16x6-5/16x11-1/4 (345x160x285)	7.5/5.3 (3.4/2.4)	
	FQZHW-04N1D	18-11/16x6-1/2x11-7/8 (475x165x300)	10.6/7.9 (4.8/3.6)	
Branch joint of indoor side	FQZHN-01D	11-7/16x4-1/8x4 (290x105x100)	0.9/0.7 (0.4/0.3)	
	FQZHN-02D	11-7/16x4-1/8x4 (290x105x100)	1.3/0.9 (0.6/0.4)	
	FQZHN-03D	12-3/16x5-1/8x5 (310x130x125)	2.0/1.3 (0.9/0.6)	
	FQZHN-04D	13-3/4x6-5/8x7-1/8 (350x170x180)	3.3/2.4 (1.5/1.1)	
	FQZHN-05D	14-3/8x7-11/16x8-1/2 (365x195x215)	4.2/3.1 (1.9/1.4)	

### 10.3 Other optional accessories

Optional accessories	Model name	Function
Outdoor controller	MD-CCM02/E	Monitor the outdoor operating parameter
Three phase electricity power protector	DPA51CM44 or HWUA/DPB71CM48	To stop the air-conditioner running in case of bad power supply such as Phase Error, Over-voltage, Under-voltage lose, phase lost and phase sequence inverse. Thus to protect the equipment.
Digital ammeter (WHM)	DTS634/DT636	Electricity Charge monitor



## 11. Functional parts and safety devices

Item	Symbol	Name	MVD-V5X252W/V2GN1	MVD-V5X280W/V2GN1	MVD-V5X335W/V2GN1	
Compressor	Inverter	Inverter compressor	E655DHD-65D2YG	E655DHD-65D2YG	E705DHD-72D2YG	
	Compressor Safety OLP	Open temperature	120°C			
	CCH	Crank case heater	DJRD-520A-1500-27.6Wx2-VHR			
Motor and Security Devices	Motor	Fan motor	Model	WZDK560-38G(B)	WZDK560-38G(B)	WZDK560-38G(B)
			Output power	465W	465W	465W
	Safety thermostat	On	115°C			
		Off	/			
	HP	High pressure switch	OFF: 44 (±1) kg/cm <sup>2</sup> /ON: 32 (±1) kg/cm <sup>2</sup>			
LP	Low pressure switch	OFF: 0.3 (±1) kg/cm <sup>2</sup> /ON: 1.0 (±1) kg/cm <sup>2</sup>				
Temperature sensor	T3,T4	Temperature sensor (condenser outlet/ambient temperature)	25°C=10KΩ			
	Discharge thermostat	Thermostat (Inverter)	BW130°C ON:130°C OFF:85°C			
Pressure sensor	HPSH	High pressure sensor (discharge)	Model: YLCGQ-45CP2-7K6J10, Character: Vout=1.1603*P+0.5(MPa)			
Functional Parts	PMV	Electronic expansion valve	D32MISZ-1R Shanghai Yinzhou			
	4-W/V	4-way valve	STF-01DN1 Foshan Hualu			
	SV	Solenoid valve	FDF2A-217-PK(2sets) , FDF6A-049-PK(2sets) Zhejiang Zhongbao			

Item	Symbol	Name	MVD-V5X400W/V2GN1	MVD-V5X450W/V2GN1	MVD-V5X500W/V2GN1	
Compressor	Inverter	Inverter compressor	E405DHD-42D2YG (2sets)	E405DHD-42D2YG (2sets)	E405DHD-36D2YG E705DHD-72D2YG	
	Compressor Safety OLP	Open temperature	120°C			
	CCH	Crank case heater	27.6Wx2x2			
Motor and Security Devices	Motor	Fan motor	Model	WZDK560-38G(B) (2sets)	WZDK560-38G(B) (2sets)	WZDK560-38G(B) (2sets)
			Output power	290W+230W	290W+230W	420W+350W
	Safety thermostat	On	115°C			
		Off	/			
	HP	High pressure switch	OFF: 44 (±1) kg/cm <sup>2</sup> /ON: 32 (±1) kg/cm <sup>2</sup>			
LP	Low pressure switch	OFF: 0.3 (±1) kg/cm <sup>2</sup> /ON: 1.0 (±1) kg/cm <sup>2</sup>				
Temperature sensor	T3,T4	Temperature sensor (condenser outlet/ambient temperature)	25°C=10KΩ			
	Discharge thermostat	Thermostat (Inverter)	BW130°C ON:130°C OFF:85°C			
Pressure sensor	HPSH	High pressure sensor (discharge)	Model: YLCGQ-45CP2-7K6J10, Character: Vout=1.1603*P+0.5(MPa)			
Functional Parts	PMV	Electronic expansion valve	D32MISZ-1R (2 sets) Shanghai Yinzhou			
	4-W/V	4-way valve	STF-01DN1 Foshan Hualu			
	SV	Solenoid valve	FDF2A-217-PK(2sets) , FDF6A-049-PK(2sets) Zhejiang Zhongbao			

**Functional parts and safety devices**

Item	Symbol	Name	MVD-V5X560W/V2GN1	MVD-V5X615W/V2GN1	
Compressor	Inverter	Inverter compressor	E705DHD-72D2YG (2sets)	E705DHD-72D2YG (2sets)	
	Compressor Safety OLP	Open temperature	120°C		
	CCH	Crank case heater	27.6W *2*2		
Motor and Security Devices	Motor	Fan motor	Model	WZDK560-38G(B) (2sets)	WZDK560-38G(B) (2sets)
			Output power	440W+350W	440W+350W
		Safety thermostat	On	115°C	
			Off	/	
	HP	High pressure switch	OFF: 44 (±1) kg/cm <sup>2</sup> /ON: 32 (±1) kg/cm <sup>2</sup>		
	LP	Low pressure switch	OFF: 0.3 (±1) kg/cm <sup>2</sup> /ON: 1.0 (±1) kg/cm <sup>2</sup>		
Temperature sensor	T3,T4	Temperature sensor (condenser outlet/ambient temperature)	25°C=10KΩ		
	Discharge thermostat	Thermostat (Inverter/Fixed discharge)	BW130°C ON:130°C OFF:85°C		
Pressure sensor	HPSH	High pressure sensor (discharge)	Model: YLCGQ-45CP2-7K6J10, Character: Vout=1.1603*P+0.5(MPa)		
Functional Parts	PMV	Electronic expansion valve	D32MISZ-1R (2 sets) Shanghai Yinzhou		
	4-W/V	4-way valve	STF-01DN1 Foshan Hualu		
	SV	Solenoid valve	FDF2A-217-PK(2sets) , FDF6A-049-PK(2sets) Zhejiang Zhongbao		

# Part 4 Installation

1. Units installation .....	122
2. Air ventilation assembly installation .....	127
3. Refrigerant piping selection .....	130
4. Refrigerant pipe installation .....	137
5. Drainage pipe engineering .....	147
6. Duct engineering .....	151
7. Heat Insulation Engineering .....	153
8. Caution for brazing .....	155
9. Remove dirt or water in the piping .....	156
10. Gas tightness test .....	156
11. Vacuum Drying .....	157
12. Additional refrigerant charge .....	159
13. Electric wiring installation .....	160
14. Running test .....	164

## 1. Units installation

### 1.1 Installation of indoor unit

#### 1.1.1 Installation procedure

Determine the installation position → Scribing and locating → Installing suspension road → Installing the indoor unit

#### 1.1.2 Cautions for installation and check

- 1) Drawing check: Confirm the specification, model and installation direction of the set.
- 2) Height: Ensure that it closely fits the ceiling.
- 3) Suspension strength: The suspension road shall be strong enough to bear the weight twice of the indoor unit to ensure that no abnormal vibration or noise is generated when the set is running.
- 4) When installing the indoor unit, ensure that sufficient space is available for installing condensate water pipe.
- 5) Horizontal degree: It shall be kept within  $\pm 1^\circ$ .

**Purpose:** Ensure smooth drainage of condensate water. Also ensure stability of the machine body to induce the risks caused by vibration and noise.

**Hidden trouble of incorrect operation:** a. Water leakage; b. Abnormal vibration and noise

- 6) Ensure sufficient maintenance & upkeep is available (keep a large enough maintenance hole, typically 400x400mm).

- 7) Avoid short-circuit ventilation.

**Purpose:** Ensure sufficient heat exchange of indoor unit and good air conditioning effect.

Risk of incorrect operation: Poor air conditioning effect; abnormal protection of the set.

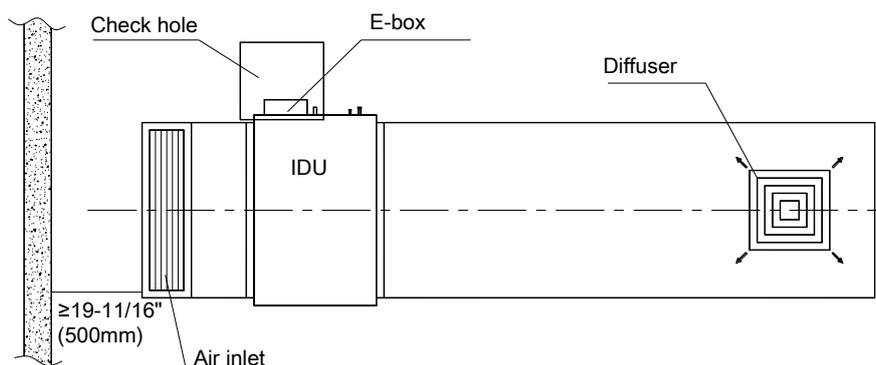

### 1.2 Installation of outdoor unit

#### 1.2.1 Acceptance and unpacking

1. After the machine arrives, check whether it is damaged during the shipment. If the surface or inner side of the machine is damaged, submit a written report to the shipping company.
2. Check whether the model, specification and quantity of the equipment conform to the contract.
3. After removing the outer package, please keep the operation instructions well and count the accessories.

#### 1.2.2 Hoisting outdoor unit

Do not remove any package before the hoisting. Use two ropes to hoist the machine, keep the machine in balance, and then raise it safely and steadily. In case of no package or if the package is damaged, use plates or packing material to protect it.

When conveying and hoisting the outdoor unit, keep it upright, ensure that the slope does not exceed  $30^\circ$ , and keep safety in mind.

### 1.3 Select installation position

- ◆ Ensure that the outdoor unit is installed in a dry, well-ventilated place.
- ◆ Ensure that the noise and exhaust ventilation of the outdoor unit do not affect the neighbors of the property owner or the surrounding ventilation.
- ◆ Ensure that the outdoor unit is installed in a well-ventilated place that is possibly closest to the indoor unit.
- ◆ Ensure that the outdoor unit is installed in a cool place without direct sunshine exposure or direct radiation of high-temp heat source.
- ◆ Do not install the outdoor unit in a dirty or severely polluted place, so as to avoid blockage of the heat exchanger in the outdoor unit.
- ◆ Do not install the outdoor unit in a place with oil pollution or full of harmful gas such as sulfurous gas.
- ◆ Do not install the outdoor unit in a place surrounded by salty air. (Except for the models with corrosion-resistant function)

### 1.4 Foundation for installation

- ◆ A solid, correct base can: Avoid the outdoor unit from sinking and avoid the abnormal noise generated due to base.
- ◆ Base types: Steel structure base or concrete base (See the figure below for the general making method)

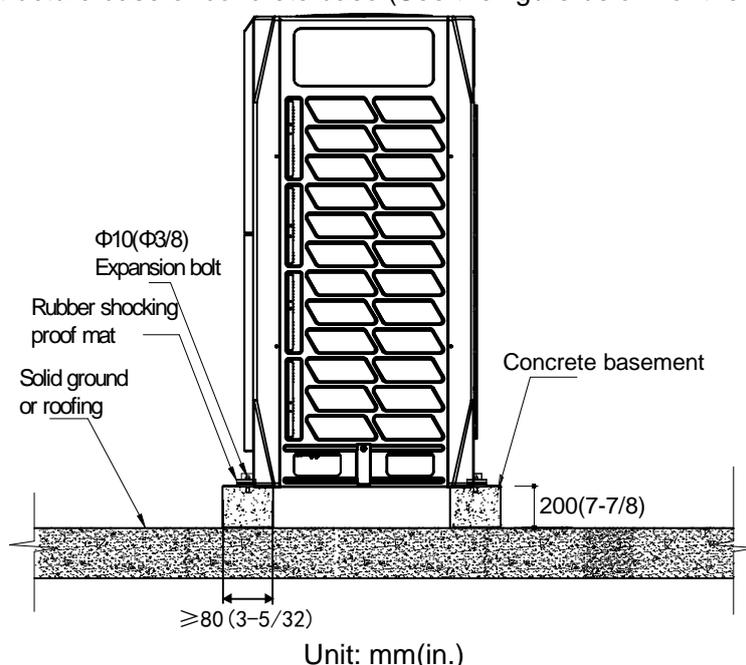

Note: The key points to make basement:

- The master unit's basement must be made on the solid concrete ground . Refer to the structure diagram to make concrete basement in detail, or make after field measurements.
- In order to ensure every point can contact equality, the basement should be on completely level.
- If the basement is placed on the roofing, the detritus layer isn't needed, but the concrete surface must be flat. The standard concrete mixture ratio is cement 1/ sand 2/ carpolite 4, and adds Φ3/8inch(10mm) strengthen reinforcing steel bar, the surface of the cement and sand plasm must be flat, border of the basement must be chamfer angle.
- Before construct the unit base, please ensure the base is directly supporting the rear and front folding edges of the bottom panel vertically, for the reason of these edges are the actual supported sites to the unit.
- In order to drain off the seeper around the equipment, a discharge ditch must be setup around the basement.
- Please check the affordability of the roofing to ensure the load capacity.
- When piping from the bottom of the unit, the base height should be no less than 7-7/8inch(200mm).

- ◆ Position illustration of screw bolt (Unit: in.( mm))

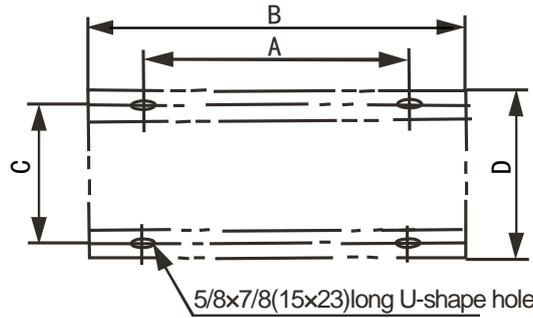

Size (in.(mm))	8, 10, 12HP	14, 16, 18, 20, 22HP
A	740(29-1/8)	1090(42-7/8)
B	990(39)	1340(52-3/4)
C	723(28-1/2)	723(28-1/2)
D	790(31-1/8)	790(31-1/8)

**1.5 Master and slave unit setting**

When the quantity of outdoor unit is more than two in one system, the outdoor unit should be placed from large capacity unit to small capacity unit. The largest capacity unit must be placed at the first branch site, and be set as master unit, while the other are set as slave units.

Take 48HP (composed by 10HP, 16HP and 22HP) as an example:

- 1) Place the 22HP at a side of the first branch site.
- 2) Place the unit from the large capacity to small (See the detail placement illustration)
- 3) Set 22HP as the master unit, while the 16HP and the 10HP as slave units.

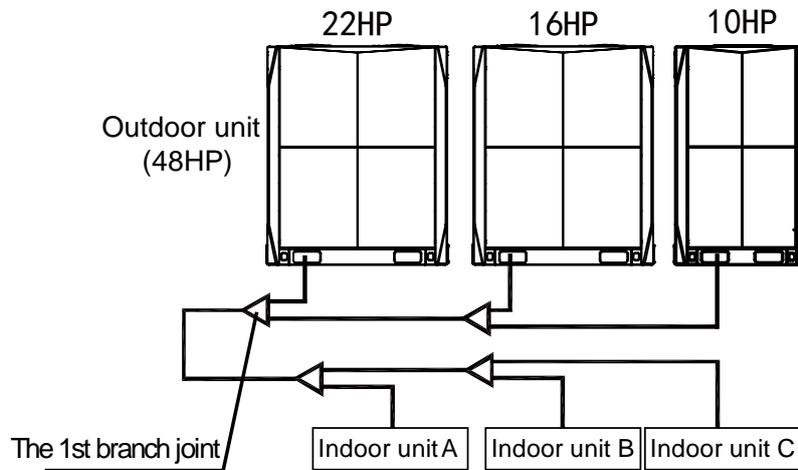

**1.6 Installation space**

- ◆ Ensure enough space for maintenance. The modules in the same system must be on the same height.
- ◆ When installing the unit, leave enough space for maintenance.

Unit: mm(in.)

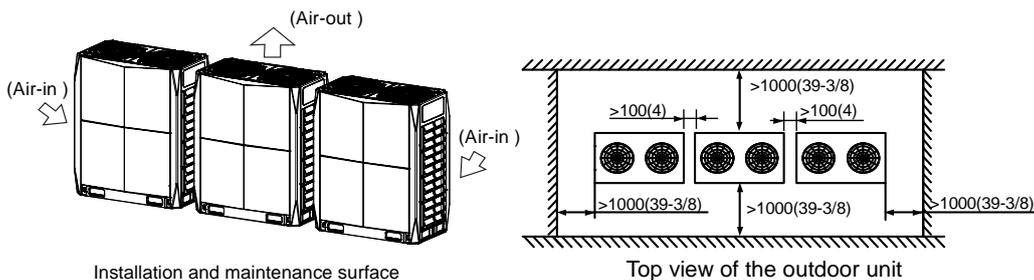

- When the outdoor unit is higher than the surrounding obstacle

Unit: mm(in.)

One row

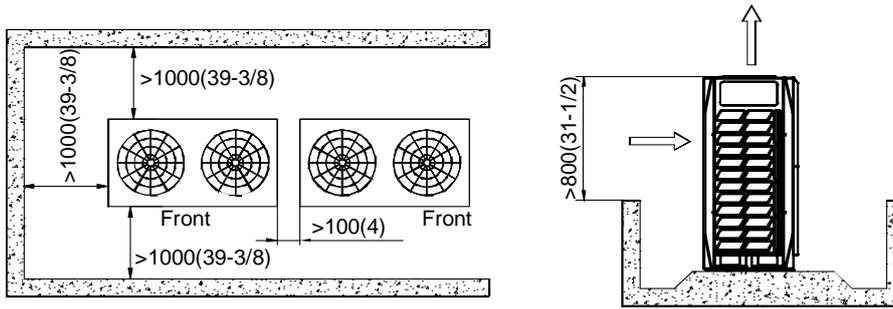

Two rows

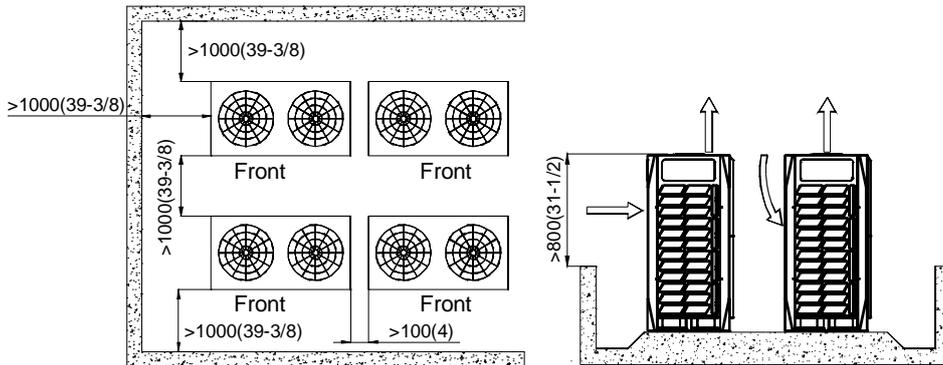

More than two rows

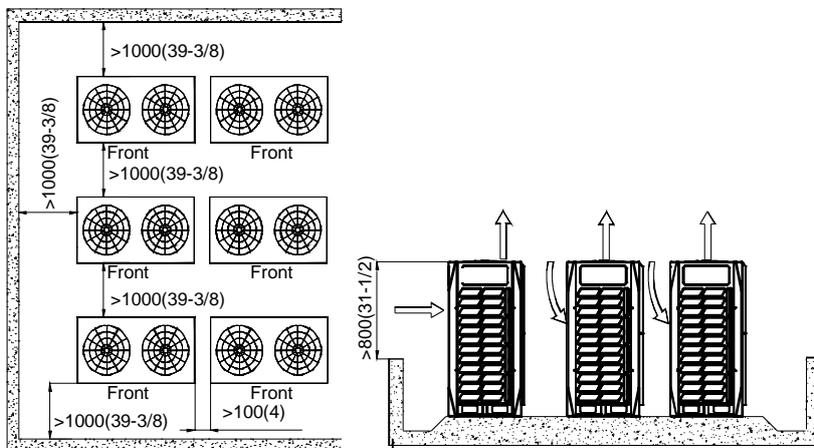

- When the outdoor unit is lower than the surrounding obstacle, to avoid cross connection of the outdoor hot air from affecting the heat exchange effect, please add an air director onto the exhaust hood of the outdoor unit to facilitate heat dissipation. See the figure below. The height of the air director is HD (namely H-h). Please make the air director on site.

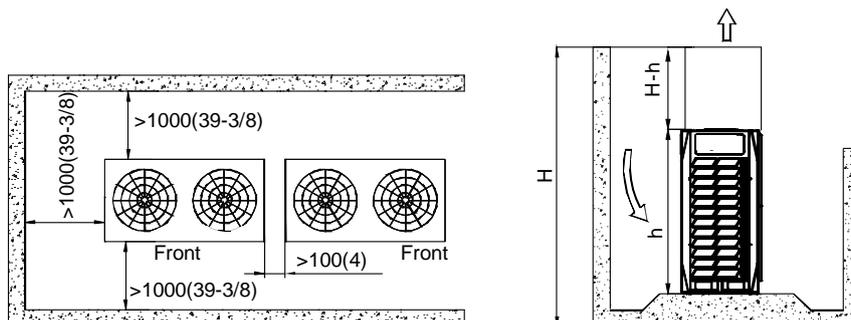

- If miscellaneous articles are piled around the outdoor unit, such articles must be 31-1/2inch(800mm) below the top of the outdoor unit. The articles must be 31-1/2inch(800mm) below the top of the outdoor unit. Otherwise, a mechanic exhaust device must be added.

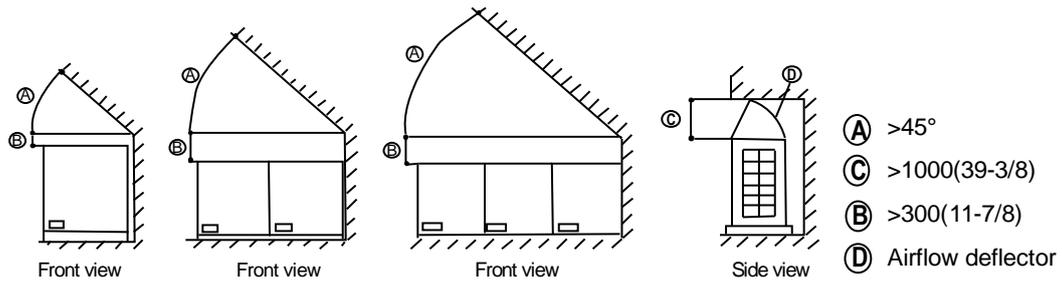

- Set the snow-proof facility

In snowy areas, facilities should be installed to prevent snow. (See the figure below) (Defective facilities may cause malfunction.) Please lift the bracket higher and install snow shield at the air inlet and air outlet.

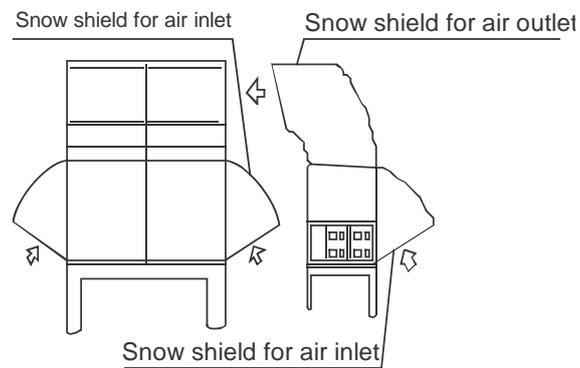



## 2. Air ventilation assembly installation

The ventilation assembly is provided at the field installation. When installing, please take off the mesh cover firstly, and then install the unit as the following method.

### 2.1 Installation of 8, 10, 12HP

#### Example A

Unit: in.( mm)

A	$A \geq 11-3/4(300)$
B	$B \geq 9-7/8(250)$
C	$C \leq 118-1/8(3000)$
D	$28-3/4(731) \leq D \leq 30-3/8(770)$
E	$E = A + 28-3/4(731)$
$\theta$	$\theta \leq 15^\circ$

ESP	Remarks
0Pa	Factory default
0~20Pa	Remove the iron filter and connect to the duct which is less than 3 meters.
$\geq 20Pa$	Need to customize.

#### Example B

Unit: in.( mm)

A	$A \geq 11-3/4(300)$
B	$B \geq 9-7/8(250)$
C	$C \leq 118-1/8(3000)$
D	$D = A + 29-1/2(750)$
$\theta$	$\theta \leq 15^\circ$

ESP	Remarks
0Pa	Factory default
0~20Pa	Remove the iron filter and connect to the duct which is less than 3 meters.
$\geq 20Pa$	Need to customize.

2.2 Installation of 14, 16, 18, 20, 22HP

Example A

Unit: in.( mm)

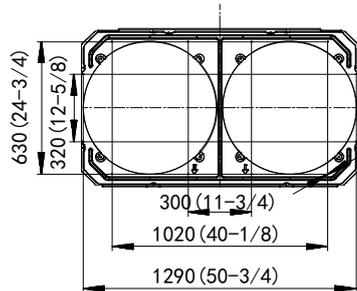
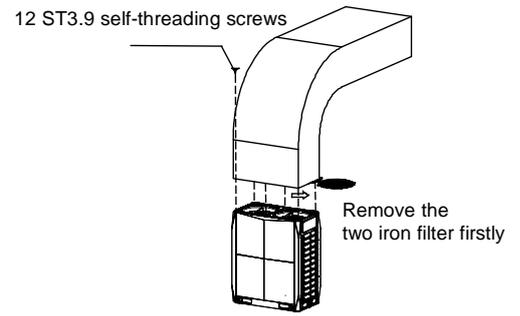
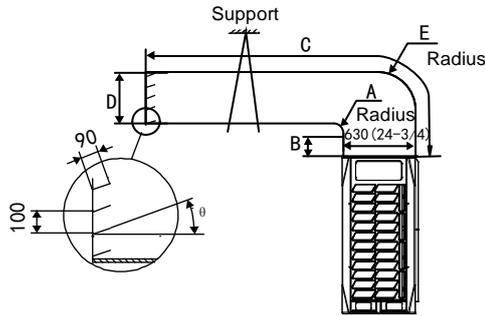
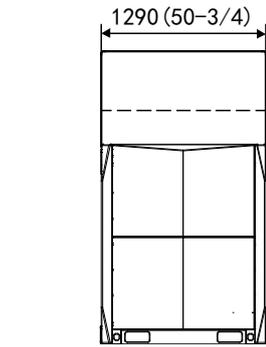

A	$A \geq 11-3/4(300)$
B	$B \geq 9-7/8(250)$
C	$C \leq 118-1/8(3000)$
D	$24-3/4(630) \leq D \leq 26(660)$
E	$E = A + 24-3/4(630)$
$\theta$	$\theta \leq 15^\circ$

ESP	Remarks
0Pa	Factory default
0~20Pa	Remove the iron filter and connect to the duct which is less than 3 meters.
$\geq 20Pa$	Need to customize.

Example B

Unit: in.( mm)

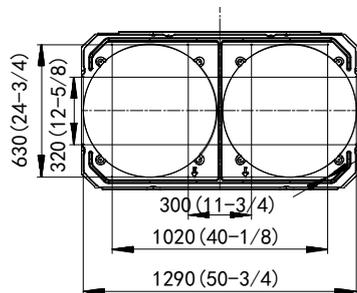
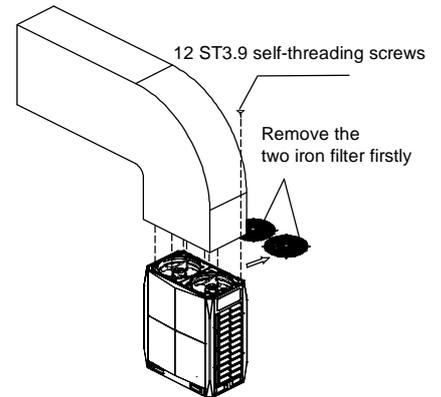
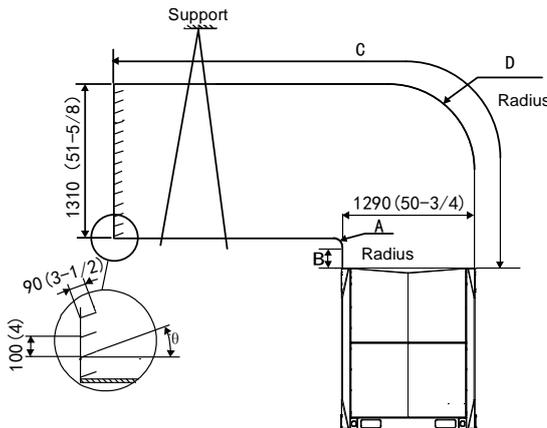
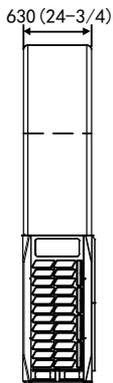

A	$A \geq 11-3/4(300)$
B	$B \geq 9-7/8(250)$
C	$C \leq 118-1/8(3000)$
D	$D = A + 50-3/4(1290)$
$\theta$	$\theta \leq 15^\circ$

ESP	Remarks
0Pa	Factory default
0~20Pa	Remove the iron filter and connect to the duct which is less than 3 meters.
$\geq 20Pa$	Need to customize.

**Outdoor fan performance**

The default static pressure of outdoor unit is 0 Pa, and 20Pa can be achieved when the steel mesh is removed.

**8/10HP**

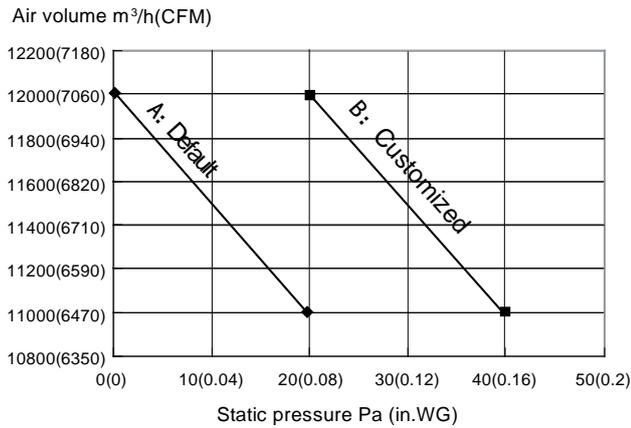

**12HP**

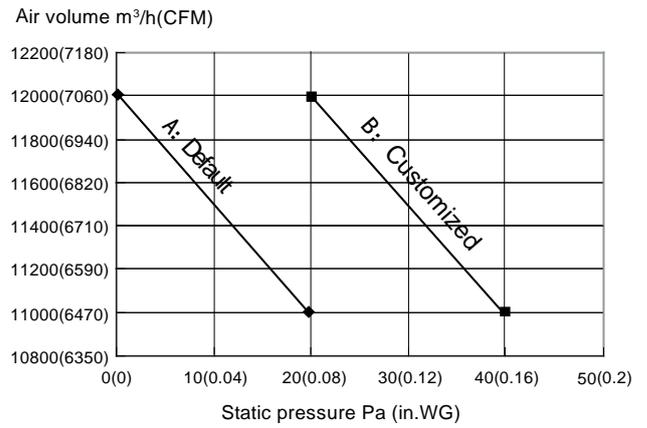

**14/16HP**

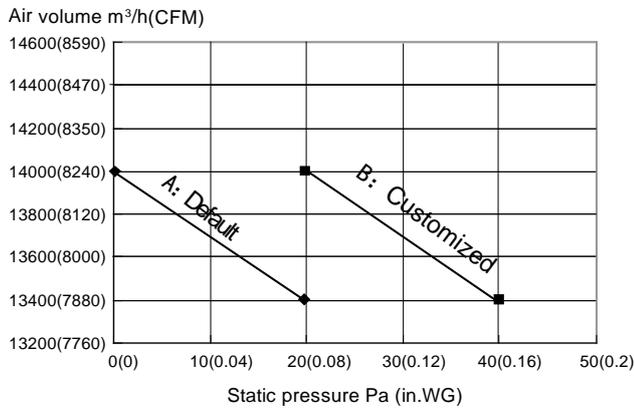

**18HP**

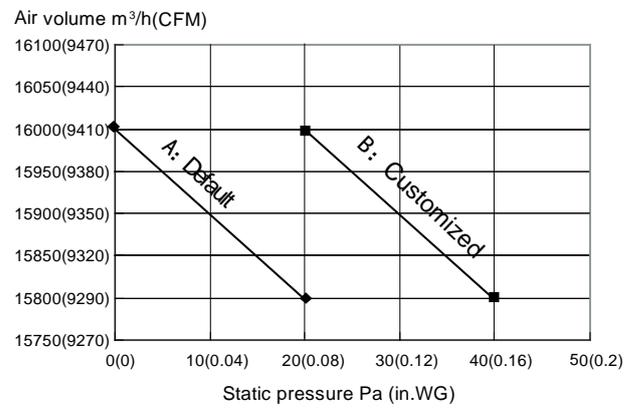

**20/22HP**

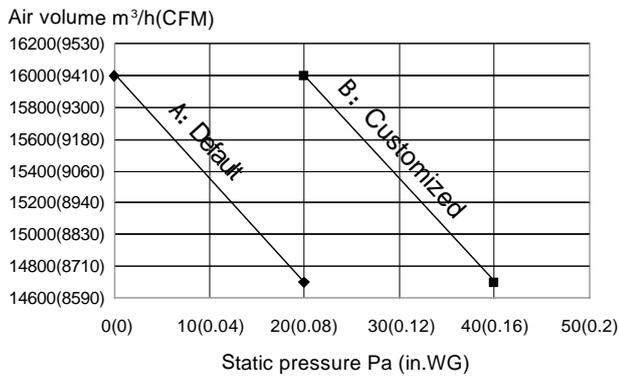

**Note:**

Before install the ventilation assembly, please remove the steel meshes firstly, otherwise, they would decrease the air supply volume.

1. Increase shutters would decrease the air supply volume, as well as cooling (heating) capacity and energy efficiency would be decreased, the larger angle of the shutter, the more effect to the unit. So we don't recommend applying shutter, if necessary to apply shutter, please ensuring the angle should not over than 15°.
2. The bending place at ventilated duct should be not more than 1(show in above figure), otherwise, operation malfunction would be caused.
3. Install the flexible connector between the unit and the air deflector pipe to avoid vibration noise.

### 3. Refrigerant piping selection

#### 3.1 Refrigerant piping length permitted value

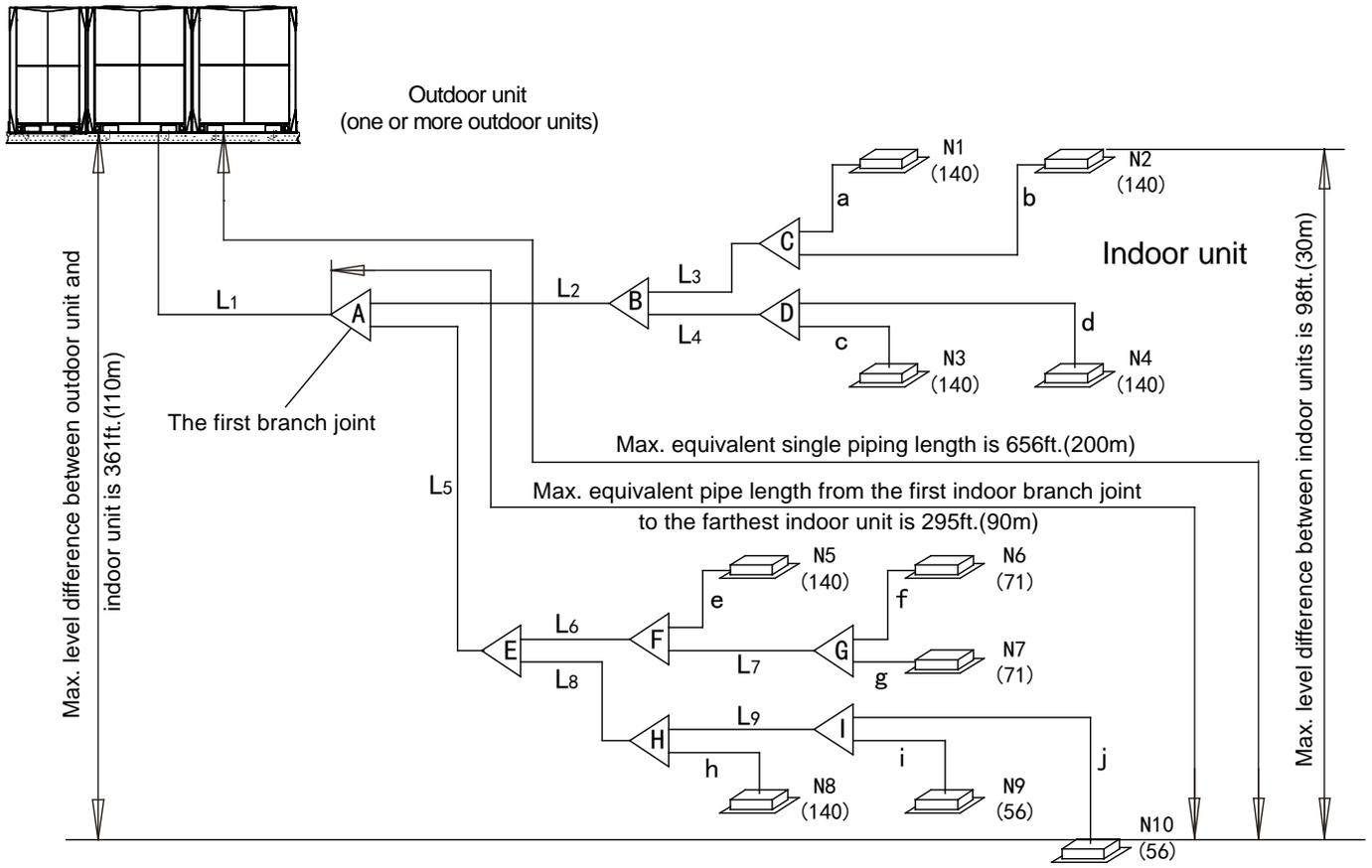

Piping length		Permitted value	Piping	
Piping length	Total piping length	≤3280ft(1000m) (refer to note 1)	$L1+(L2+L3+L4+L5+L6+L7+L8+L9) \times 2+a+b+c+d+e+f+g+h+i+j$	
	Single piping length	Actual length	≤574ft(175m)	
		Equivalent length	≤656ft(200m) (refer to note 2)	$L1+L5+L8+L9+j$
	Piping length from the first branch joint to the farthest indoor unit	≤131/295ft(40/90m) (refer to note 3)	$L5+L8+L9+j$	
Level difference	Level difference between indoor unit and outdoor unit	Outdoor unit is up	≤ 295ft(90m) (refer to note 4)	/
		Outdoor unit is down	≤361ft(110m) (refer to note 5)	/
	Level difference between indoor units	≤98ft(30m)	/	

Note:

The indoor units should be installed as possible as equal in the both sides of the U-shape branch joint.

1. When counting the total piping length, the actual pipe length branch joints should be double:

$$\text{Total piping length} = L1+(L2+L3+L4+L5+L6+L7+L8+L9) \times 2+a+b+c+d+e+f+g+h+i+j \leq 3280\text{ft}(1000\text{m})$$

2. The equivalent length of each branch joint is 1.64ft(0.5m).

3. The allowable piping length from the first branch joint to the farthest indoor unit should be equal to or less than 131ft(40m), but when the following conditions are all met, the allowable length can be extended to 295ft (90m).

- The piping length from each indoor unit to the nearest branch joint should be less than 131ft(40m). (a, b, c, d, e, f, g, h, i,  $j \leq 131\text{ft}(40\text{m})$ )

- The length difference between (the outdoor unit to the farthest indoor unit) and (the outdoor unit to the nearest indoor unit)  $\leq 131\text{ft}(40\text{m})$ .

The farthest indoor unit: N10

The nearest indoor unit: N1

$$(L1+L5+L8+L9+j)-(L1+L2+L3+a) \leq 131\text{ft}(40\text{m})$$

- It needs to increase the size of pipes which between the first branch joint and the last branch joint. (Please change the pipe diameter at field) If the pipe diameter of the main slave pipe is the same as the main pipe, then it is no need to be increased.

When:  $131\text{ft}(40\text{m}) < L5+L8+L9+j \leq 295\text{ft}(90\text{m})$ , L2, L3, L4, L5, L6, L7, L8, L9 are needed to increase the pipe diameter.

Increasing size as followed: unit in.(mm)

$\Phi 3/8(9.53) \rightarrow$ $\Phi 1/2(12.7)$	$\Phi 1/2(12.7) \rightarrow$ $\Phi 5/8(15.9)$	$\Phi 5/8(15.9) \rightarrow$ $\Phi 3/4(19.1)$	$\Phi 3/4(19.1) \rightarrow$ $\Phi 7/8(22.2)$	$\Phi 7/8(22.2) \rightarrow$ $\Phi 1(25.4)$	$\Phi 1(25.4) \rightarrow$ $\Phi 1-1/8(28.6)$
$\Phi 1-1/8(28.6) \rightarrow$ $\Phi 1-1/4(31.8)$	$\Phi 1-1/4(31.8) \rightarrow$ $\Phi 1-1/2(38.1)$	$\Phi 1-1/2(38.1) \rightarrow$ $\Phi 1-5/8(41.3)$	$\Phi 1-5/8(41.3) \rightarrow$ $\Phi 1-3/4(44.5)$	$\Phi 1-3/4(44.5) \rightarrow$ $\Phi 2-1/8(54.0)$	

4. When the outdoor unit is higher than indoor units and the level difference is over  $65.6\text{ft}(20\text{m})$ , it is recommended to set an oil return bend every  $32.8\text{ft}(10\text{m})$  in the gas pipe of the main pipe, the specification of the oil return bend refers to below figure.

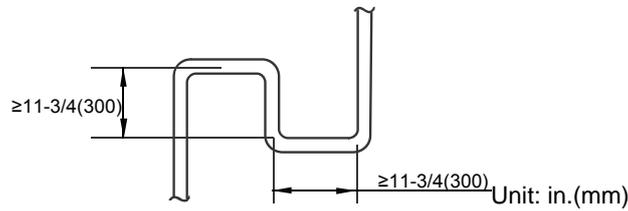

5. When the outdoor unit is lower than indoor units and the level difference is more than  $131\text{ft}(40\text{m})$ , the liquid pipe of the main pipe need to increase one size.

### 3.2 Refrigerant piping selection

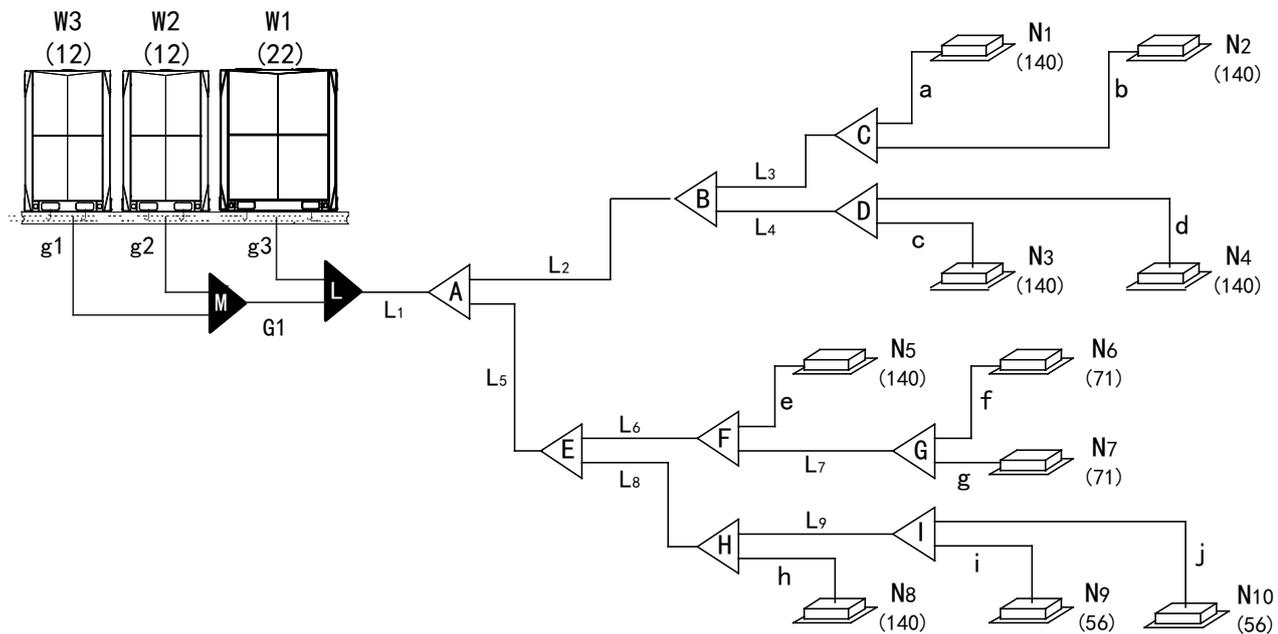

- Pipe name

Main pipe	L1
Indoor unit main pipe	L2, L3, L4, L5, L6, L7, L8, L9
Indoor unit auxiliary pipe (from indoor unit to the nearest branch joint)	a, b, c, d, e, f, g, h, i, j
Indoor unit branch joint assembly	A, B, C, D, E, F, G, H, I
Outdoor unit branch joint assembly	L, M
Outdoor connection pipe	g1, g2, g3, G1

➤ Table 1: Indoor unit main pipe selection (L1~L9) Unit: in.(mm)

Capacity of indoor unit kW(kBtu/h)	Indoor unit main pipe in.(mm)		
	Gas pipe	Liquid pipe	Available branching pipe assembly
A<16.6(56.6)	Φ5/8(15.9)	Φ3/8(9.53)	FQZHN-01D
(56.6)16.6≤A<23(78.5)	Φ3/4(19.1)	Φ3/8(9.53)	FQZHN-01D
(78.5)23≤A<33(112.6)	Φ7/8(22.2)	Φ3/8(9.53)	FQZHN-02D
(112.6)33≤A<46(157)	Φ1-1/8(28.6)	Φ1/2(12.7)	FQZHN-03D
(157)46≤A<66(225.2)	Φ1-1/8(28.6)	Φ5/8(15.9)	FQZHN-03D
(225.2)66≤A<92(313.9)	Φ1-1/4(31.8)	Φ3/4(19.1)	FQZHN-03D
(313.9)92≤A<135(460.6)	Φ1-1/2(38.1)	Φ3/4(19.1)	FQZHN-04D
(460.6)135≤A<180(614.2)	Φ1-5/8(41.3)	Φ7/8(22.2)	FQZHN-05D
(614.2)180≤A	Φ1-3/4(44.5)	Φ1(25.4)	FQZHN-05D

➤ Table 2: Main pipe selection (L1) Unit: in.(mm)

Model	Main pipe in.(mm)					
	When the equivalent length of all liquid pipes<295ft.(90m)			When the equivalent length of all liquid pipes≥295ft.(90m)		
	Gas pipe	Liquid pipe	The 1 <sup>st</sup> branch pipe	Gas pipe	Liquid pipe	The 1 <sup>st</sup> branch pipe
8HP	Φ7/8(22.2)	Φ3/8(9.53)	FQZHN-02D	Φ7/8(22.2)	Φ1/2(12.7)	FQZHN-02D
10HP	Φ7/8(22.2)	Φ3/8(9.53)	FQZHN-02D	Φ1(25.4)	Φ1/2(12.7)	FQZHN-02D
12-14HP	Φ1(25.4)	Φ1/2(12.7)	FQZHN-02D	Φ1-1/8(28.6)	Φ5/8(15.9)	FQZHN-03D
16HP	Φ1-1/8(28.6)	Φ1/2(12.7)	FQZHN-03D	Φ1-1/4(31.8)	Φ5/8(15.9)	FQZHN-03D
18-22HP	Φ1-1/8(28.6)	Φ5/8(15.9)	FQZHN-03D	Φ1-1/4(31.8)	Φ3/4(19.1)	FQZHN-03D
24HP	Φ1-1/8(28.6)	Φ5/8(15.9)	FQZHN-03D	Φ1-1/4(31.8)	Φ3/4(19.1)	FQZHN-03D
26-34HP	Φ1-1/4(31.8)	Φ3/4(19.1)	FQZHN-03D	Φ1-1/2(38.1)	Φ7/8(22.2)	FQZHN-04D
36-50HP	Φ1-1/2(38.1)	Φ3/4(19.1)	FQZHN-04D	Φ1-1/2(38.1)	Φ7/8(22.2)	FQZHN-04D
52-66HP	Φ1-5/8(41.3)	Φ7/8(22.2)	FQZHN-05D	Φ1-3/4(44.5)	Φ1(25.4)	FQZHN-05D
68-88HP	Φ1-3/4(44.5)	Φ1(25.4)	FQZHN-05D	Φ2-1/8(54.0)	Φ1(25.4)	FQZHN-06D

**Note: the main pipe L1 can be selected form table1 or table2, the larger size should be finally selected.**

● Outdoor unit branch pipe assembly

No. of outdoor units	Outdoor combination
2 units	
3 units	
4 units	

➤ Table 3: Outdoor unit connection pipe selection (g1, g2, g3, g4, G1, G2) Unit: in.(mm)

Pipe		Gas pipe	Liquid pipe
g1,g2,g3,g4	8~12HP	Φ1(25.4)	Φ1/2(12.7)
	14~22HP	Φ1-1/4(31.8)	Φ5/8(15.9)
G1		Φ1-1/2(38.1)	Φ3/4(19.1)
G2		Φ1-5/8(41.3)	Φ7/8(22.2)

➤ Table 4: Outdoor unit branching pipe assembly selection (L, M, N)

Outdoor unit quantity	Parallel connect with the branch pipes
2 units	L: FQZHW-02N1D
3 units	L+M: FQZHW-03N1D
4 units	L+M+N: FQZHW-04N1D

➤ Table 5: Indoor unit to the nearest branch joint (a~j) Unit: in.(mm)

Capacity of indoor unit kW(kBtu/h)	The pipe length from indoor unit to the nearest branch joint ≤32.8ft.(10m)		The pipe length from indoor unit to the nearest branch joint >32.8ft.(10m)	
	Gas pipe	Liquid pipe	Gas pipe	Liquid pipe
A≤4.5(15.4)	Φ1/2(12.7)	Φ1/4(6.35)	Φ5/8(15.9)	Φ3/8(9.53)
A≥5.6 (19.1)	Φ5/8(15.9)	Φ3/8(9.53)	Φ3/4(19.1)	Φ1/2(12.7)

### 3.3 Example

The example is as blow:

(Provided that the capacity of outdoor unit is (12+12+22) HP, the equivalent length of all pipes in this system is larger than 90m, the pipe length from the 1<sup>st</sup> branch joint to the farthest indoor unit is less than 40m, and the pipe from indoor unit to the nearest branch joint is less than 10m.

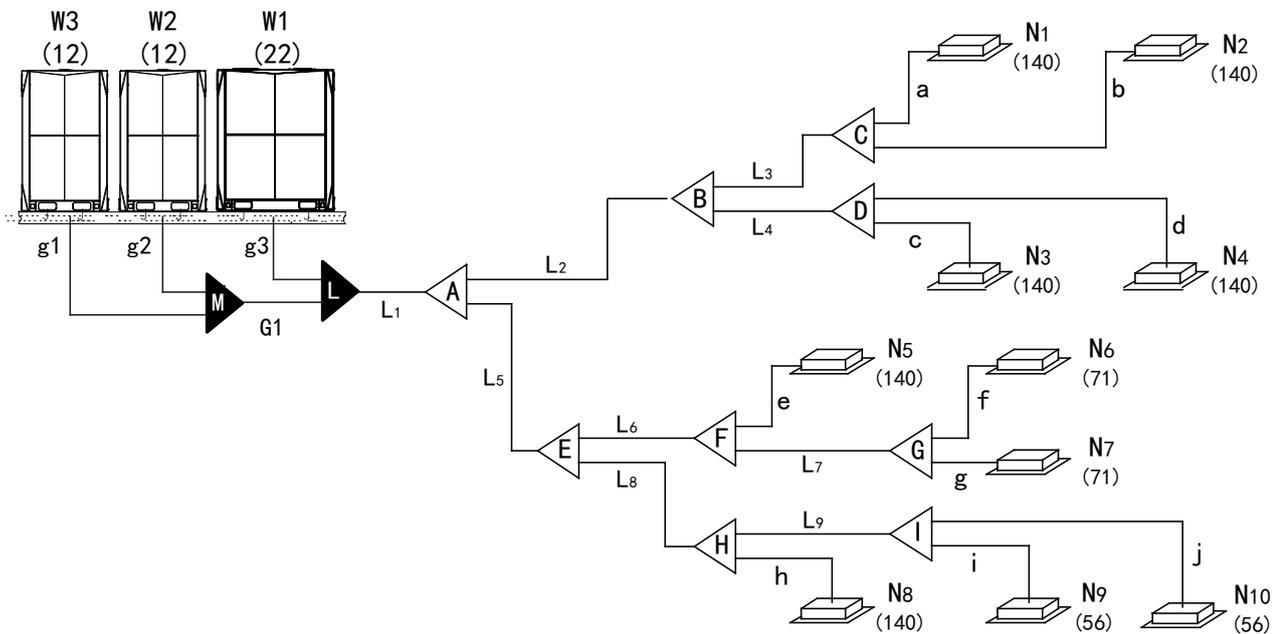

- Select indoor unit pipes from indoor unit to the nearest branch joint: a, b, c, d, e, f, g, h, i, j.  
Refer to table 5, the pipes of a~j are Φ5/8(15.9)/ Φ3/8(9.53).
- Select the main pipe L1, indoor unit main pipes L2~L9 and branch joints B~I:
  - The downstream indoor units of L3 are N1 and N2, which capacity is 14×2=28kW(95.5kBtu/h). Refer to table 1, the indoor unit main pipe L3 is Φ7/8(22.2)/ Φ3/8(9.53). The branch pipe assembly C is FQZHN-02D.
  - The downstream indoor unit of L4 is N3 and N4, which capacity is 14×2=28kW(95.5kBtu/h). Refer to table 1, the indoor unit main pipe L4 is Φ7/8(22.2)/ Φ3/8(9.53). The branch pipe assembly D is FQZHN-02D.

- The downstream indoor unit of L7 is N6 and N7, which capacity is  $7.1 \times 2 = 14.2 \text{ kW} (48.5 \text{ kBtu/h})$ . Refer to table 1, the indoor unit main pipe L7 is  $\Phi 5/8(15.9) / \Phi 3/8(9.53)$ . The branch pipe assembly G is FQZHN-01D.
- The downstream indoor units of L9 are N9 and N10, which capacity is  $5.6 \times 2 = 11.2 \text{ kW} (38.2 \text{ kBtu/h})$ . Refer to table 1, the indoor unit main pipe L9 is  $\Phi 5/8(15.9) / \Phi 3/8(9.53)$ . The branch pipe assembly I is FQZHN-01D.
- The downstream indoor units of L2 are N1, N2, N3 and N4, which capacity is  $14 \times 4 = 56 \text{ kW} (191.1 \text{ kBtu/h})$ . Refer to table 1, the indoor unit main pipe L2 is  $\Phi 1-1/8(28.6) / \Phi 5/8(15.9)$ . The branch pipe assembly B is FQZHN-03D.
- The downstream indoor unit of L6 is N5, N6 and N7, which capacity is  $14 + 7.1 \times 2 = 28.2 \text{ kW} (96.2 \text{ kBtu/h})$ . Refer to table 1, the indoor unit main pipe L6 is  $\Phi 7/8(22.2) / \Phi 3/8(9.53)$ . The branch pipe assembly F is FQZHN-02D.
- The downstream indoor units of L8 are N8, N9 and N10, which capacity is  $14 + 5.6 \times 2 = 25.2 \text{ kW} (86 \text{ kBtu/h})$ . Refer to table 1, the indoor unit main pipe L8 is  $\Phi 7/8(22.2) / \Phi 3/8(9.53)$ . The branch pipe assembly H is FQZHN-02D.
- The downstream indoor units of L5 are N5, N6, N7, N8, N9 and N10, which capacity is  $14 \times 2 + 7.1 \times 2 + 5.6 \times 2 = 53.4 \text{ kW} (182.2 \text{ kBtu/h})$ . Refer to table 1, the indoor unit main pipe L2 is  $\Phi 1-1/8(28.6) / \Phi 5/8(15.9)$ . The branch pipe assembly E is FQZHN-03D.

3. Select main pipe L1 and branch joint A:

- For the capacity of outdoor unit is 46HP, the equivalent length of all pipes in this system is larger than 295ft(90m), refer to table 2, the main pipe L1 is  $\Phi 1-1/2(38.1) / \Phi 7/8(22.2)$ , the branch pipe assembly A is FQZHN-04D.
- The downstream indoor units of L1 are N1~N10, which capacity is  $14 \times 6 + 7.1 \times 2 + 5.6 \times 2 = 109.4 \text{ kW} (373.3 \text{ kBtu/h})$ . Refer to table 1, the main pipe L1 is  $\Phi 1-1/2(38.1) / \Phi 3/4(19.1)$ . So we finally select the larger pipe  $\Phi 1-1/2(38.1) / \Phi 7/8(22.2)$  as main pipe L1.

4. Outdoor unit connection pipe (g1, g2, g3, G1, L+M) selection (refer to table 3, table 4)

- The pipe g1 is connected to 12HP outdoor unit. Refer to table 3, the diameter of g1 is  $\Phi 1(25.4) / \Phi 1/2(12.7)$ .
- The pipe g2 is connected to 12HP outdoor unit. Refer to table 3, the diameter of g2 is  $\Phi 1(25.4) / \Phi 1/2(12.7)$ .
- The pipe g3 is connected to 22HP outdoor unit. Refer to table 3, the diameter of g3 is  $\Phi 1-1/4(31.8) / \Phi 5/8(15.9)$ .
- Refer to table 3, the diameter of G1 is  $\Phi 1-1/4(31.8) / \Phi 3/4(19.1)$ .
- The quantity of combined outdoor units is three. Refer to table 4, the outdoor branch assembly is L+M: FQZHW-03N1D.

3.4 Branch joint dimension

3.4.1 Indoor branch joint dimension

Branch model	Gas side joints	Liquid side joints
FQZHN-01D		

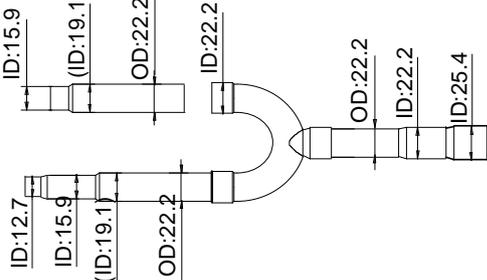
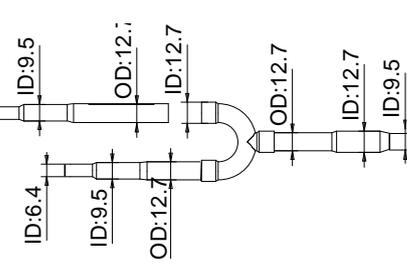
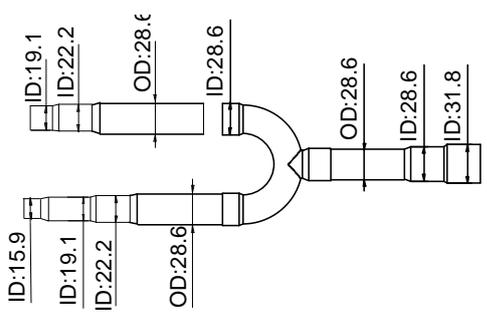
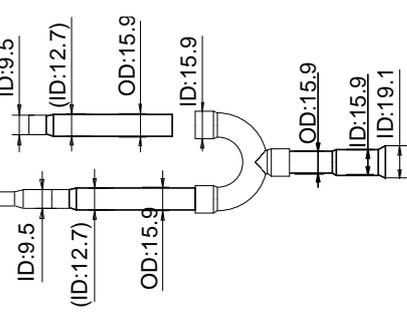
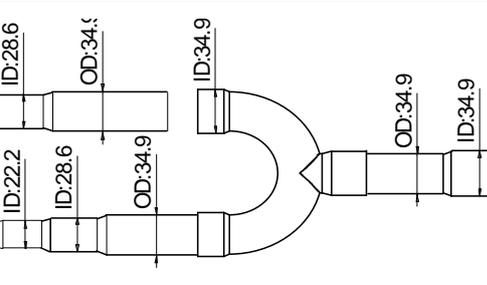
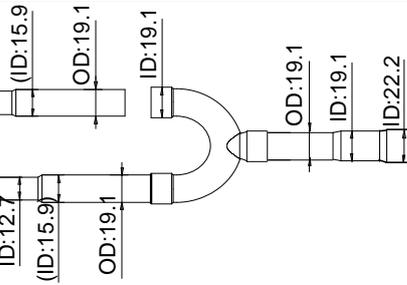
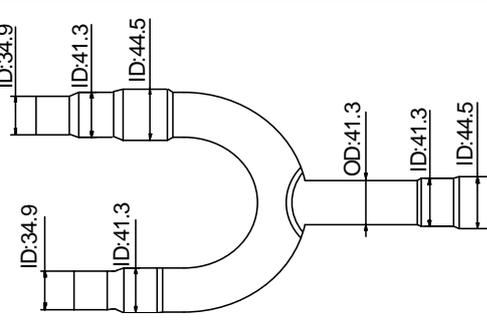
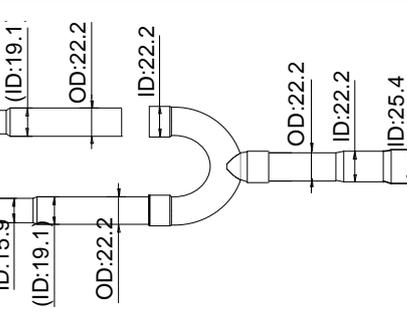
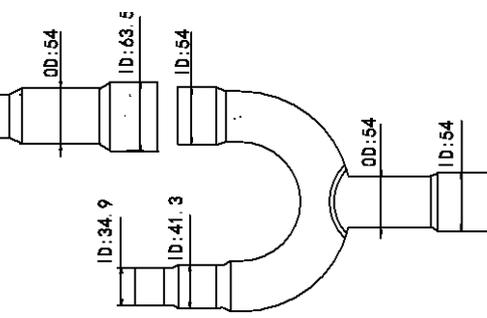
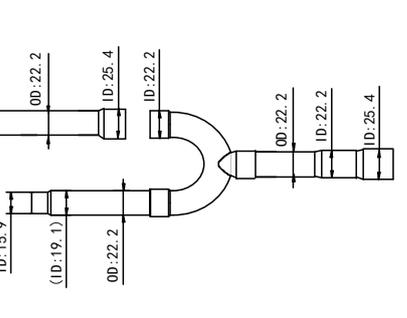

**Indoor branch joint dimension**

Branch model	Gas side joints	Liquid side joints
FQZHN-02D	 <p>Diagram showing gas side joints for FQZHN-02D. Dimensions include: ID:15.9, (ID:19.1), OD:22.2, ID:22.2, OD:22.2, ID:22.2, ID:25.4, ID:12.7, ID:15.9, (ID:19.1), OD:22.2.</p>	 <p>Diagram showing liquid side joints for FQZHN-02D. Dimensions include: ID:6.4, ID:9.5, OD:12.7, ID:12.7, OD:12.7, ID:12.7, ID:9.5, ID:6.4, ID:9.5, (ID:12.7), OD:12.7.</p>
FQZHN-03D	 <p>Diagram showing gas side joints for FQZHN-03D. Dimensions include: ID:19.1, ID:22.2, OD:28.6, ID:28.6, OD:28.6, ID:28.6, ID:31.8, ID:15.9, ID:19.1, ID:22.2, OD:28.6.</p>	 <p>Diagram showing liquid side joints for FQZHN-03D. Dimensions include: ID:9.5, (ID:12.7), OD:15.9, ID:15.9, OD:15.9, ID:15.9, ID:19.1, ID:6.4, ID:9.5, (ID:12.7), OD:15.9.</p>
FQZHN-04D	 <p>Diagram showing gas side joints for FQZHN-04D. Dimensions include: ID:22.2, ID:28.6, OD:34.9, ID:34.9, OD:34.9, ID:34.9, ID:38.1, ID:19.1, ID:22.2, ID:28.6, OD:34.9.</p>	 <p>Diagram showing liquid side joints for FQZHN-04D. Dimensions include: ID:12.7, (ID:15.9), OD:19.1, ID:19.1, OD:19.1, ID:19.1, ID:22.2, ID:9.5, ID:12.7, (ID:15.9), OD:19.1.</p>
FQZHN-05D	 <p>Diagram showing gas side joints for FQZHN-05D. Dimensions include: ID:34.9, ID:41.3, ID:44.5, OD:41.3, ID:41.3, ID:44.5, ID:34.9, ID:41.3, ID:44.5.</p>	 <p>Diagram showing liquid side joints for FQZHN-05D. Dimensions include: ID:15.9, (ID:19.1), OD:22.2, ID:22.2, OD:22.2, ID:22.2, ID:25.4, ID:12.7, ID:15.9, (ID:19.1), OD:22.2.</p>
FQZHN-06D	 <p>Diagram showing gas side joints for FQZHN-06D. Dimensions include: ID:41.3, OD:54, ID:63.5, ID:54, ID:34.9, ID:41.3, OD:54, ID:54, ID:63.5.</p>	 <p>Diagram showing liquid side joints for FQZHN-06D. Dimensions include: (ID:19.1), OD:22.2, ID:25.4, ID:22.2, ID:15.9, (ID:19.1), OD:22.2, OD:22.2, ID:22.2, ID:25.4.</p>

3.4.2 Outdoor branch joint dimension

Branch model	Gas side joints	Liquid side joints
FQZHW-02N1D		
FQZHW-03N1D		
FQZHW-04N1D		

## 4. Refrigerant pipe installation

### 4.1 Basic requirements

#### 4.1.1 Operation procedure

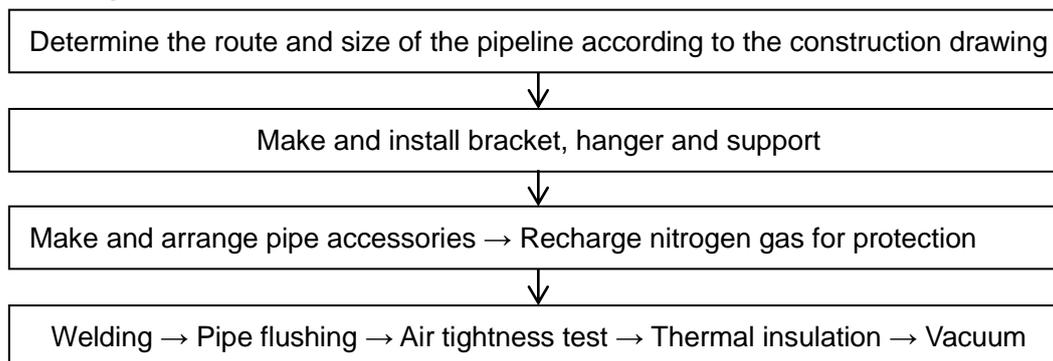

#### 4.1.2 Three principles for refrigerant piping

Item	Reasons	Countermeasure
Dry	The rain comes into the pipe/Engineering water comes into the pipe/Condensate water in the pipe	The process of tubing must be criterion → Blow cleanly → Vacuum
Cleanness	There are oxide produced by welding/Outside dust /Sundries	Charge nitrogen gas to prevent when welding/Attention the cleanness during the piping process → Blow cleanly
Air tightness	Imprecision welding/Unqualified airproof to bell-mouth/Leakage of the fringe	Use the suited welding rod to weld/Comply to the welding operation criteria/Comply to bell-mouth connecting operation criteria/Comply to the interface operation criteria → Air tightness test

**Caution:** Removing oil for copper pipe of a system that uses R410A

For the system that uses R410A, oil-free copper pipes should be selected (they can also be customized). If ordinary (oily) copper pipes are used, it must be cleaned with gauze that is dipped into tetrachloroethylene solution.

Purpose of cleansing copper pipe: Remove the lube (industrial oil used during the processing of the copper pipe) attached to the inner wall of the copper pipe. The ingredients of such lube are different from those of the lube used by the R410A refrigerant, and they will produce deposit through reaction, which may cause complicated system fault.

**Special Note:** Never use CCl<sub>4</sub> for pipe cleansing and flushing, or the system will be seriously damaged.

#### 4.1.3 Support for refrigerant pipe

##### 1. Fixing horizontal pipe

When the air conditioner is running, the refrigerant pipe will deform (for example, shrunk/expanded or inclined downward). To avoid pipe damage, use hanger or support to support it (see the table below for the criteria).

Pipe Diameter in.(mm)	Less than Φ25/32(20)	Φ25/32~1-37/64(20-40)	Larger than Φ1-37/64(40)
Interval between support points ft.(m)	3.28(1)	4.92(1.5)	6.56(2)

In general, gas pipe and liquid pipe should be suspended in parallel, and the interval between support points should be selected according to the diameter of the air pipe. Since the temperature of the flowing refrigerant will change as the operation and working condition change, which will result in hot expansion and cold shrinkage of the refrigerant pipe, so the pipe with thermal insulation should not be clamped tightly, otherwise the copper pipe may get broken due to stress concentration.

##### 2. Fixing vertical pipe

Fix the pipe along the wall according to the pipeline route. Round log should be used at the pipe clip to replace thermal insulation material, "U"-shape pipe should be fixed outside the round log, and the round log should be provided with anticorrosion treatment.

Pipe Diameter in.(mm)	Less than Φ25/32(20)	Φ25/32~1-37/64(20-40)	Larger than Φ1-37/64(40)
Interval between support points ft.(m)	4.92(1.5)	6.56(2)	8.2(2.5)

3. Local fixing

To avoid stress concentration due to expansion and shrinkage of the pipe, it is usually required to conduct local fixing beside the wall through-holes of the branch pipe and end pipe.

**4.1.4 Requirements for installing branch pipe subassembly**

When laying the branch pipe subassembly, pay attention to the following:

- 1) Do not replace branch pipe with tee pipe.
- 2) Follow the construction drawing and installation instructions to confirm the models of branch pipe subassembly as well as the diameters of main pipe and branch pipe.
- 3) Neither sharp bend (an angle of 90°) nor connection to other branch pipe subassembly is allowed at places within 500mm away from the branch pipe subassembly.
- 4) Try best to install the branch pipe subassembly at a place that facilitates welding (if doing so is impossible, it is recommended to prefabricate the subassembly).
- 5) Install vertical or horizontal branch joint, and ensure that the horizontal angle is within 10°. Refer to the right side picture:

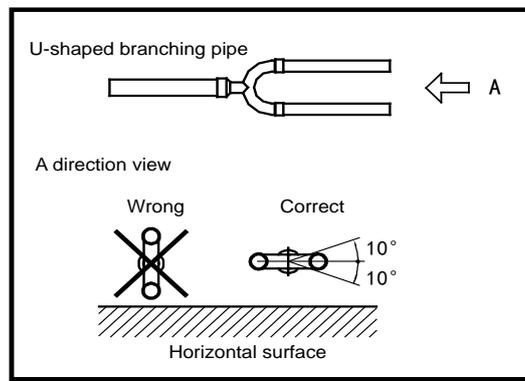

- 6) For avoid oil accumulate at the outdoor unit, please install the branching pipes properly.

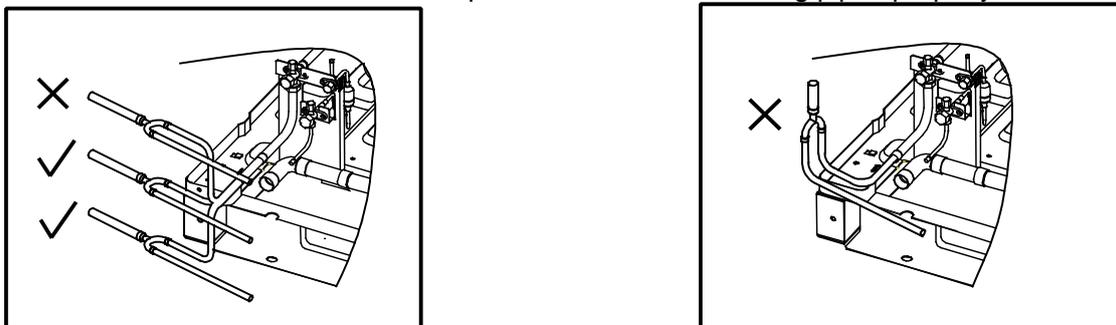

- 7) To ensure even diversion of refrigerant, pay attention to the distance between the branch pipe subassembly and the horizontal straight pipe.

- a. Ensure that the distance between the bending point of copper pipe and the horizontal straight pipe section of the adjacent branch pipe is larger than or equal to 1.64ft.(0.5m).
- b. Ensure that the distance between the horizontal straight pipe sections of the two adjacent branch pipes is larger than or equal to 1.64ft.(0.5m).
- c. Ensure that the distance between the branch pipe and the horizontal straight pipe section used to connect the indoor unit is larger than or equal to 1.64ft.(0.5m).

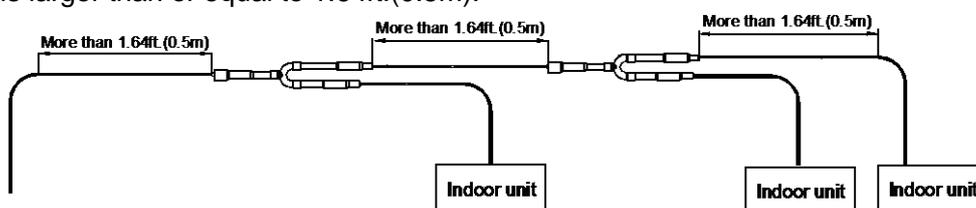

**4.2 Storage and maintain of copper pipe**

**4.2.1 Pipe carriage and storage**

1. Avoid the pipe from bending or deforming during the carriage.
2. Seal the openings of the copper pipe with end cover or adhesive tape during the storage.
3. Place the coil upright to avoid compressing deformation due to self-weight.
4. Use wooden support to ensure that the copper pipe is higher than the ground, so as to make the pipe dust-proof and water-proof.
5. Take dust-proof and water-proof measures at both ends of the pipe.
6. Keep the pipes on special bracket or bench at specified place on the construction site.

**4.2.2 Correct to seal the opening**

1. There are two ways for opening sealing:
  - 1) Sealing with cover or adhesive tape (suitable for short-term storage)
  - 2) Sealing welding (suitable for long-term storage)

Caution: The openings of the copper pipe must be sealed at any time during the construction.

• Method of sealing with cover or adhesive tape

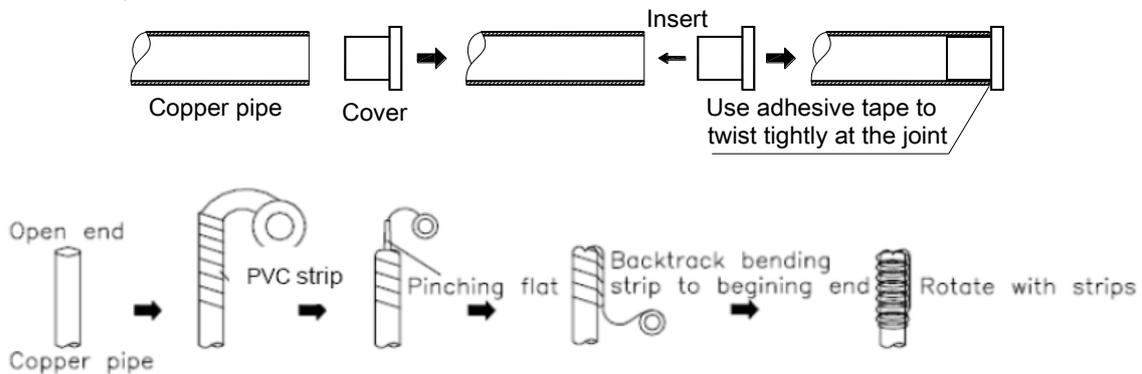

It is recommended to seal the openings of the pipe with both cover and adhesive tape.

• Method of sealing welding



2. Special attention:

- 1) When putting the copper pipe through the hole in the wall (dirt is easy to enter into the pipe), the pipe orifice should be sealed with cover.
- 2) When the copper pipe goes outside the wall, ensure that no rain water can enter the pipe, particularly when the pipe is placed upright.
- 3) Before completing the pipe connection, seal the openings of the pipe with covers.
- 4) Place the openings of the pipe vertically or horizontally.

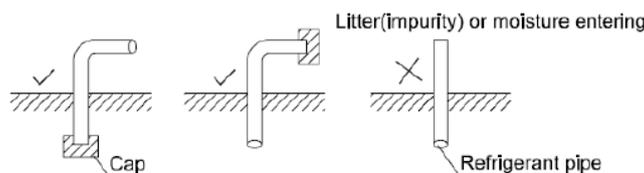

5) Before putting the pipe outside the wall, seal the opening of the pipe with a cover.

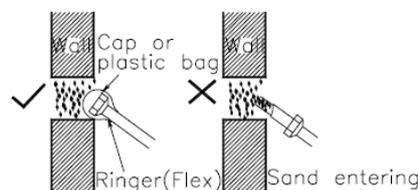

6) Do not place the pipe on the ground directly, or keep it away from ground friction.

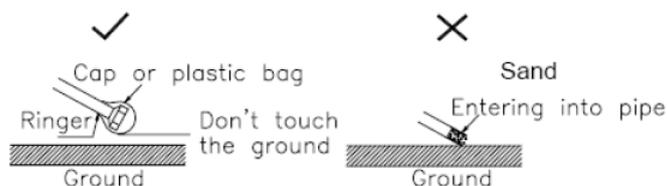

7) When conduct piping on a raining day, remember to seal the openings of the pipe first.

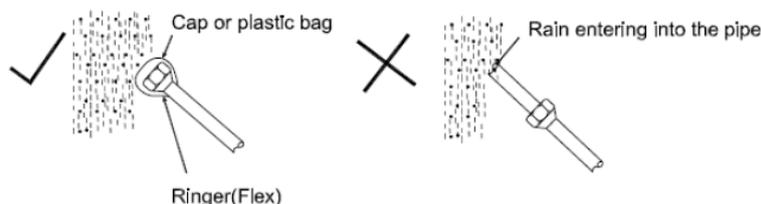

### 4.3 Processing of copper pipe

#### 4.3.1 Pipe cutting

##### 1. Tool

Use a pipe cutter instead of a saw or cutting machine to cut the pipe.

##### 2. Correct operation procedure:

Rotate the pipe evenly and slowly, and apply force to it. Cut the pipe off while ensuring that it does not deform.

##### 3. Risk if a saw or cutting machine is used to cut pipe:

Copper chip will enter the pipe (in this case, it will be very hard to clean up), or which may even enter the compressor or blocking the throttling unit.

#### 4.3.2 Rectify opening of copper pipe

##### 1. Purpose

Clear out the burr at the opening of the copper pipe, clean the inside of the pipe, and rectify the opening of the pipe, so as to avoid scratch at the opening to be sealed during flaring.

##### 2. Operation procedure

- 1) Use a scraper to remove the inner spurs. When doing so, keep the opening of the pipe downwards to avoid copper chip from entering the pipe.
- 2) After the chamfering is completed, use veiling to remove the copper chip out of the pipe.
- 3) Ensure no scar of produced, so as to avoid the pipe from getting broken during flaring.
- 4) If the pipe end obviously deforms, cut the end off and then cut the pipe again.

#### 4.3.3 Pipe expansion

1. Purpose: Expand the opening of the pipe so that another copper pipe can be inserted to replace direct connection and reduce welding spots.

2. Highlight: Ensure that the connection part is smooth and even; after cutting the pipe off, remove the inner spurs.

3. Operation method: Insert the expanding header of the pipe expander into the pipe to expand the pipe. After completing pipe expansion, rotate the copper pipe a small angle to rectify the straight line scratch left by the expanding header.

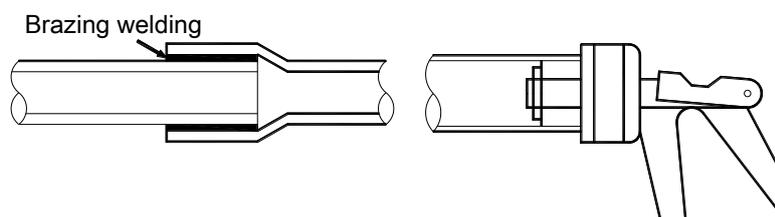

**4.3.4 Bell-mouthed opening**

1. Purpose: Flaring bell-mouthed opening is used for screw thread connection.
2. Highlight:
  - 1) Before performing the bell-mouthed opening operation, perform fire annealing for the hard pipe.
  - 2) Use pipe cutter to cut pipe to ensure even cross section and avoid refrigerant leakage; do not use a steel saw or metal cutting device to cut pipe, otherwise the cross section will get deformed and the copper chip will enter the pipe.
  - 3) Remove burr carefully to avoid scar on the bell-mouthed opening, which may lead to refrigerant leakage.
  - 4) When connecting pipes, use two spanners (one torque wrench and one non-adjustable spanner).
  - 5) Before conducting opening bell-mouthed, install pipe onto the flaring nut.
  - 6) Use proper torque to tighten the flaring nut..

Pipe Diameter In.(mm)	Torque		Legend
	(kgf-cm)	(N-cm)	
1/4" (6.35)	144~176	1420~1720	
3/8" (9.52)	333~407	3270~3990	
1/2" (12.7)	504~616	4950~6030	
5/8" (15.88)	630~770	6180~7540	
3/4" (19.05)	990~1210	9270~11860	

Caution: When you are tightening the flaring nut with a spanner, the tightening torque will be suddenly increased at a certain point. From this point, further tighten the flaring nut to the angles shown below.

Pipe Diameter in.(mm)	Angle of further tightening	Recommended length of tool lever in.(mm)
3/8" (9.52)	60°~90°	About 7-7/8 (200)
1/2" (12.7)	30°~60°	About 9-27/32 (250)
5/8" (15.88)	30°~60°	About 11-13/16 (300)

7) Check whether the surface of the flaring opening is damaged. The size of the flaring opening is as shown below.

Pipe Diameter In.(mm)	R410A	Legend
	Size of Flaring Opening (A)	
1/4 (6.35)	8.7~9.1	
3/8 (9.52)	12.8~13.2	
1/2 (12.7)	16.2~16.6	
5/8 (15.9)	19.3~19.7	
3/4 (19.1)	23.6~24.0	

**Cautions:**

- a. Apply some refrigeration oil onto the inner surface and outer surface of the flaring opening, to facilitate the connection or rotation of the flaring nut, ensure close sticking between the sealing surface and the bearing surface, and avoid pipe bending.
- b. Ensure that the flaring opening is not cracked or deformed, otherwise it cannot be sealed or, after the system runs for some time, refrigerant leakage will occur.

**4.3.5 Pipe bending**

1. Method

- 1) Manual bending: Suitable for thin copper pipes ( $\Phi 1/4''(6.35\text{mm})$ -  $\Phi 1/2''(12.7\text{mm})$ ).
- 2) Mechanical bending: Suitable in a wide range of copper pipes ( $\Phi 1/4''(6.35\text{mm})$ -  $\Phi 2-41/64''(67\text{mm})$ ). Spring bender, manual bender or electric bender is used.

Purpose: Reduce welding joints and required elbows, and improve engineering quality; In order to save material, no joint is needed.

**2. Caution**

- 1) When bending a copper pipe, ensure that there is no twinkle or deformation on the inner side of the pipe.
- 2) When using a spring bender, ensure that the bender is clean before inserting it in the copper pipe.
- 3) When using a spring bender, ensure that the bending angle does not exceed  $90^\circ$ , otherwise twinkle will appear on the inner side of the pipe, and the pipe may easily get broken.
- 4) Ensure that the pipe does not sink during the bending process; ensure that the cross section of the bending pipe is larger than  $2/3$  of the original area, otherwise it cannot be used.

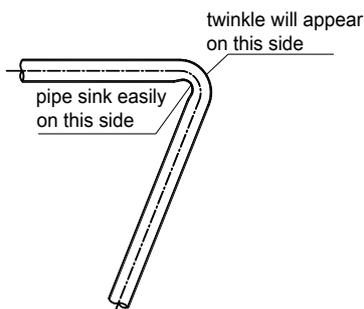

**4.4 Brazing welding operation**

**4.4.1 Selecting refrigerant pipe**

- 1. All pipe use shall comply with national or local standards (for example, pipe diameter, material, thickness, etc.)
- 2. Specification: Seamless phosphorus to oxygenate copper pipe
- 3. Try best to use straight pipe or coil and avoid too much brazing welding.

Note: Select the pipes according to the pipe diameters shown below (O—coil, 1/2H—straight pipe)

Outer Diameter in.(mm)	Material	Minimum Thickness in.(mm)	Outer Diameter	Material	Minimum Thickness	Outer Diameter	Material	Minimum Thickness
$\Phi 1/4(6.35)$	O	$1/32(0.8)$	$\Phi 3/4(19.1)$	O	$3/64(1.0)$	$\Phi 1-1/2(38.1)$	1/2H	$1/16(1.5)$
$\Phi 3/8(9.52)$	O	$1/32(0.8)$	$\Phi 7/8(22.2)$	1/2H	$3/64(1.2)$	$\Phi 1-3/4(44.5)$	1/2H	$1/16(1.5)$
$\Phi 1/2(12.7)$	O	$1/32(0.8)$	$\Phi 1(25.4)$	1/2H	$3/64(1.2)$	$\Phi 2-1/8(54.0)$	1/2H	$5/64(1.8)$
$\Phi 5/8(15.9)$	O	$3/64(1.0)$	$\Phi 1-1/8(28.6)$	1/2H	$3/64(1.3)$	$\Phi 2-5/8(67.0)$	1/2H	$5/64(1.8)$

**4.4.2 Nitrogen filling for protecting copper pipe during brazing welding**

- 1. Purpose: Avoid oxide scale from appearing on the inner wall of the copper pipe in the high temperature
- 2. Risks of non-protective welding:

If no sufficient nitrogen is charged into the refrigerant pipe being welded, oxides will be generated on the inner wall of the copper pipe. These oxides will block the refrigerant system, which will lead to all kinds of malfunctions such as burn-out the compressor, poor cooling efficiency.

To avoid these problems, charge nitrogen continuously into the refrigerant pipe during the brazing welding, and ensure that the nitrogen passes through the operating point until the welding is completed and the copper pipe cools down completely. The schematic diagram for nitrogen charging is shown below.



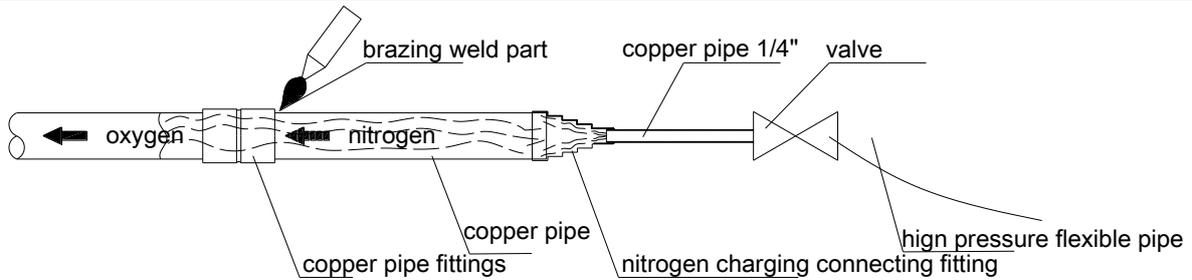

3. Making nitrogen-charging pipe joint

When welding the pipe joint, connect the nitrogen-charging joint to the pipe fittings to be welded. The nitrogen-charging joint is shown below:

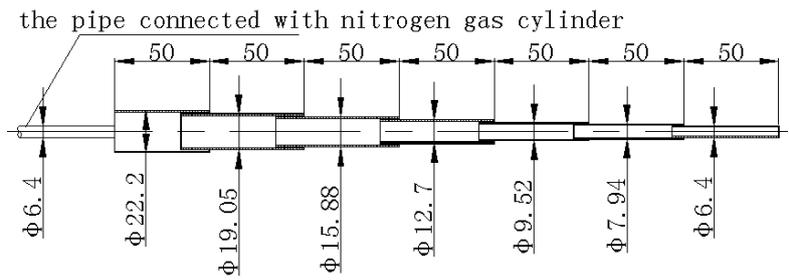

4. Cautions for welding pipe fittings

- 1) Adopt transition pipe.
- 2) Charge nitrogen from the side of the short pipe, because short distance may result in perfectible nitrogen replacement effect.

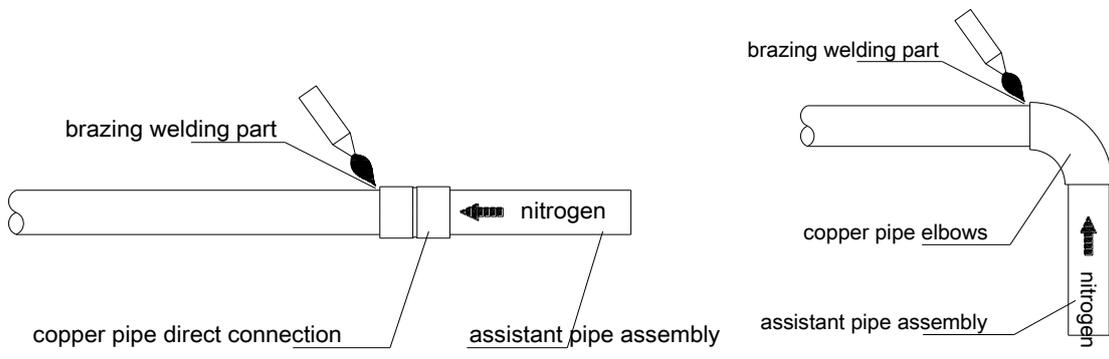

5. Standard operation of brazing welding

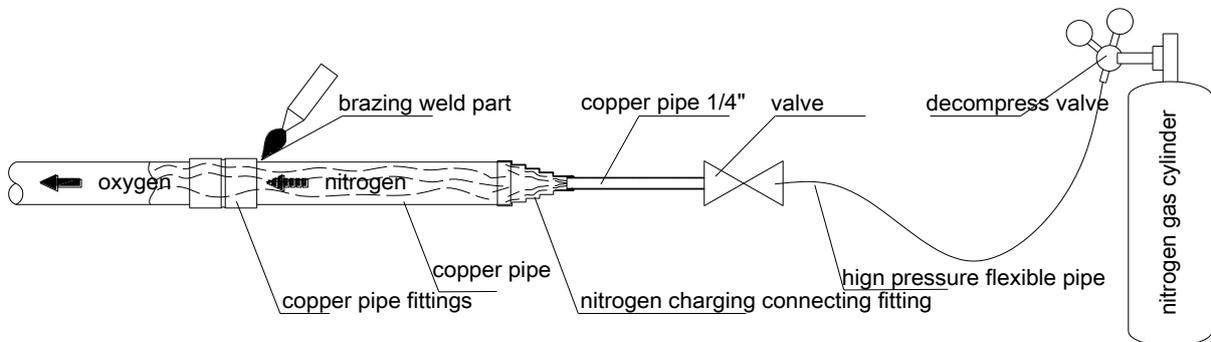

Highlight

- 1) Control the nitrogen pressure to be about 0.2-0.3kgf/cm<sup>2</sup> during the welding.
- 2) Ensure the gas is nitrogen; oxygen will easily leads explosion, so it is forbidden.
- 3) Use pressure reducing valve, and control the pressure of the charged nitrogen to be about 0.2kg/ cm<sup>2</sup>.

- 4) Select a proper position for charging nitrogen.
- 5) Ensure that the nitrogen passes through the welding spots.
- 6) If the pipeline between the position for charging nitrogen and the welding spot is rather long, ensure that the nitrogen is charged for sufficient time so as to discharge all the air from the welding spot.
- 7) After completing the welding, charge the nitrogen continuously until the pipe cools down completely.
- 8) Try best to conduct welding downwards or horizontally and avoid face-down welding.

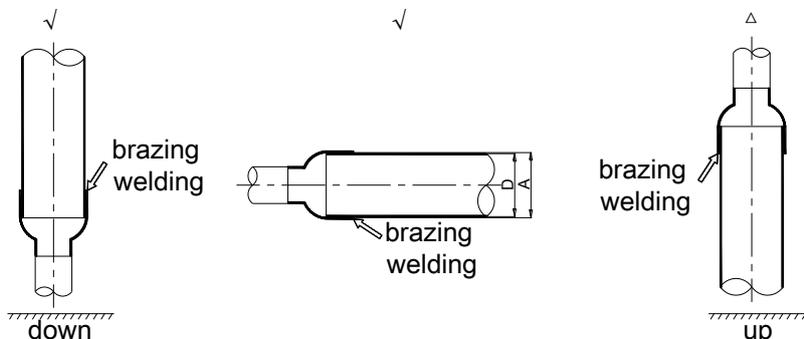

**6. Cautions**

- 1) Take fire-prevention measures when conducting welding (ensure that a fire extinguisher is available beside the operating position).
- 2) Avoid getting burnt.
- 3) Pay attention to the fit gap of the position where the pipe is inserted.

Note: The follow table shows the relation between the minimum embedded depth and gap at the copper pipe joint.

Type	Outer diameter of pipe (D) (in.(mm))	Minimum inlaid depth (B) (in.(mm))	Gap A—D (in.(mm))
	$13/64(5) < D < 5/16(8)$	15/64(6)	0.002(0.05)-
	$5/16(8) < D < 15/32(12)$	9/32(7)	0.01(0.21)
	$15/32(12) < D < 5/8(16)$	5/16(8)	0.002(0.05)-
	$5/8(16) < D < 63/64(25)$	25/64(10)	0.01(0.27)
	$63/64(25) < D < 1-3/8(35)$	15/32(12)	0.002(0.05) –
	$1-3/8(35) < D < 1-49/64(45)$	35/64(14)	0.014(0.35)

**4.5 Pipe cleaning**

**4.5.1 Flushing copper pipe**

1. Function: use pressure gas to flush pipeline (raw material or welded assembly) for eliminating dust, trash and moisture. Solid impurity is hard to be washed out, so special attention shall be drawn to the protection of copper pipeline during construction.

2. Purpose

- 1) Eliminate oxide powder or part oxide layer in copper pipe.
- 2) Help to clear out dirt and humidity in pipe.

3. Risk in case of no flushing:

If the remaining solid impurity and moisture in pipeline could not be eliminated effectively, serious malfunctions shall happen, such as ice blockage, dirt blockage and compressor being jammed.

**4.5.2 Procedure of flushing**

1. Mounting pressure adjusting valve on nitrogen gas cylinder. The applied gas must be nitrogen. If adopting polytetrafluoro ethylene or carbon dioxide, there is a risk of condensation. If using oxygen, there is a risk of explosion.
2. Making use of inflation tube to connect outlet of pressure adjusting valve and inlet at liquid pipe side of

outdoor unit.

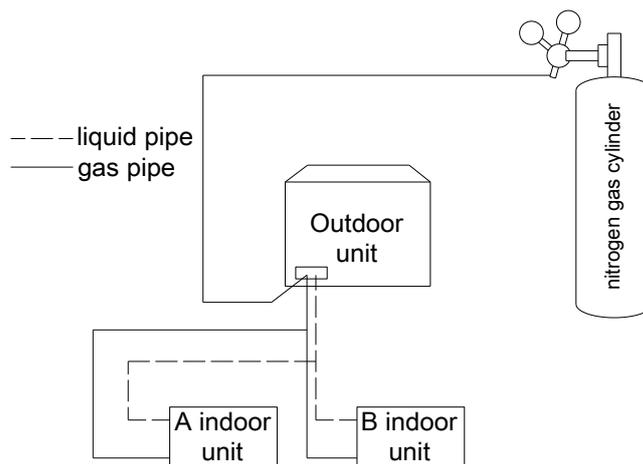

3. Use blind plug to block all connectors of liquid side copper line (including unit B) soundly, excluding indoor unit A.

4. Turn on nitrogen gas cylinder valve, and then pressurize to 5kgf/cm<sup>2</sup> gradually through adjusting valve.

5. Check whether nitrogen has passed through the liquid pipe at the side of indoor unit A. Connector at the side of indoor unit body has been covered by tape to prevent the entering of dirt.

#### 4.5.3 Detailed steps for flushing

1. Hold proper blockage material (such as block bag and white cotton) to push against the main pipe opening at the gas side of indoor unit.

2. When pressure increases and hands could not push against the opening, suddenly release pipe opening (flushing for first time).

Repeat above step1 and step 2 to re-flush dirt (flushing for multi-times)

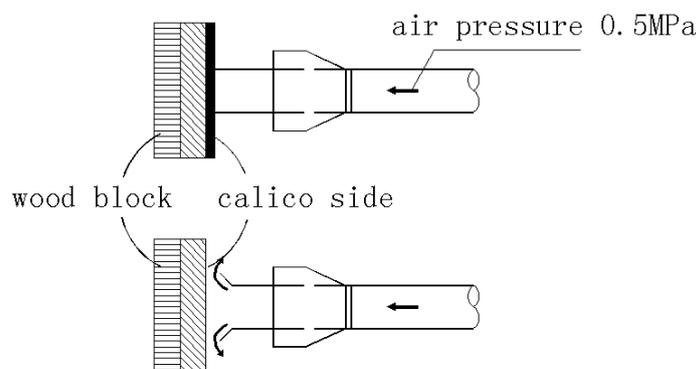

3. During flushing, place a piece of white cotton at the pipe opening for checking, and you shall find some humidity occasionally.

Way of thoroughly drying pipeline is as follows:

1) Making use of nitrogen gas to flush the inner part of pipe until no dirt and humidity.

2) Carry out vacuum drying operation (see vacuum drying of MDV refrigerant piping in detail).

3) Shut down nitrogen main valve.

4) Repeat above operations to the connected copper pipe of all indoor units.

5) Sequence of flushing: when pipeline has been connected to system, sequence of flushing is from far to near, that is, in light of principal unit, flushing from the farthest pipe opening to principal unit in turn (i.e.

1)-2)-3)-4)-5)-6)).

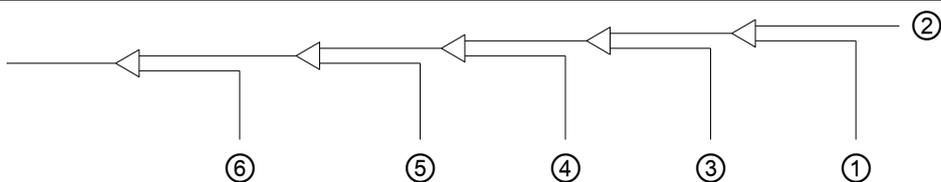

Caution: When flushing one pipe opening, block all pipe openings which are connected to this opening.

6) After finishing flushing, seal soundly all openings linked with atmosphere to prevent the entering of dust, trash and moisture.

#### 4.6 Piping connection between outdoor units

All connection pipes between outdoor units should be horizontal, it is not allowed the concave at junction site.

The height of each connection pipe between outdoor units is not allowed to over the height of refrigerant outlet pipe.

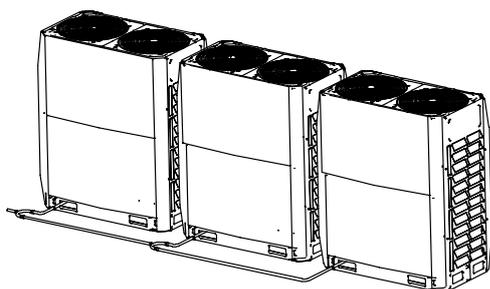

√ Correct way

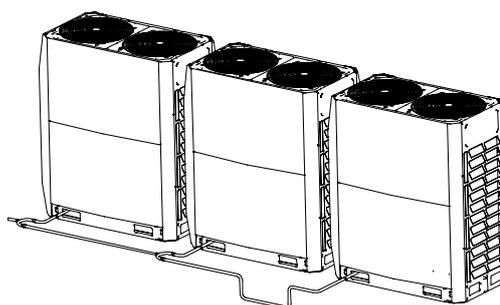

× Wrong way

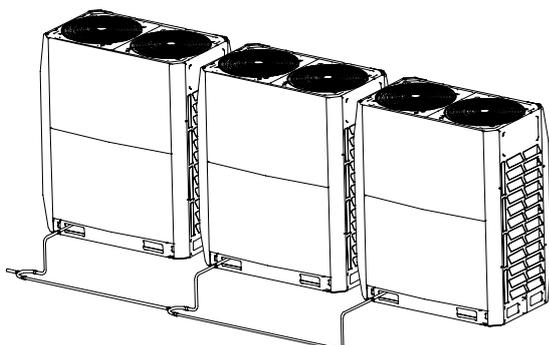

√ Correct way

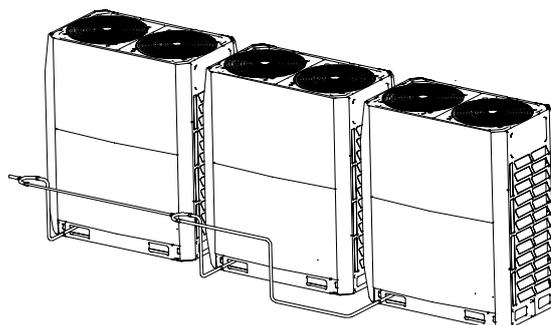

× Wrong way

#### 4.7 Branch pipe installation

The branching pipe must be installed horizontally and error angle of it should not be larger than 10°. Otherwise, refrigerant assignment will be uneven and malfunction will be caused.

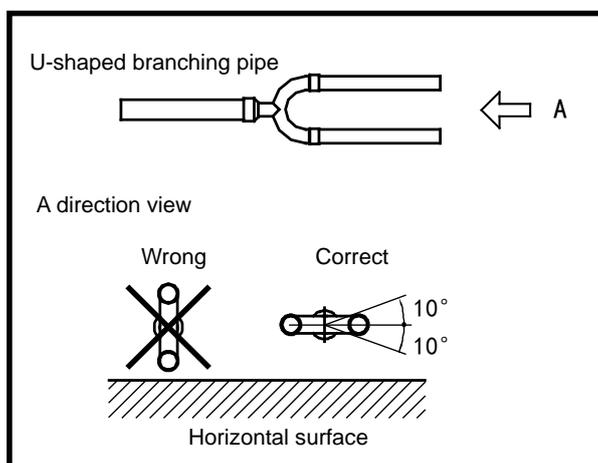

For avoiding oil accumulate at the outdoor unit, please install the branching pipes properly.

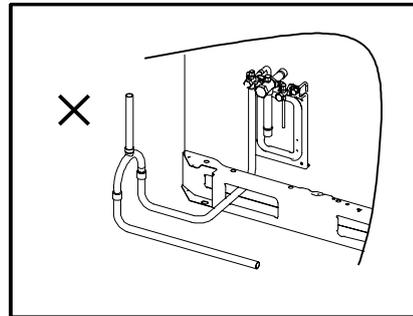
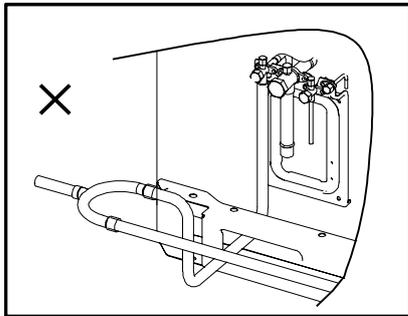
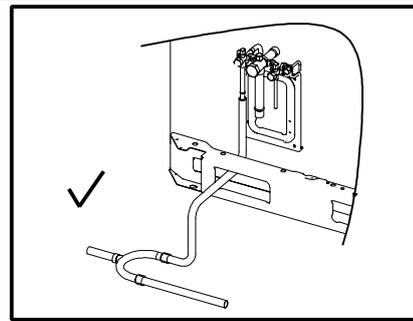
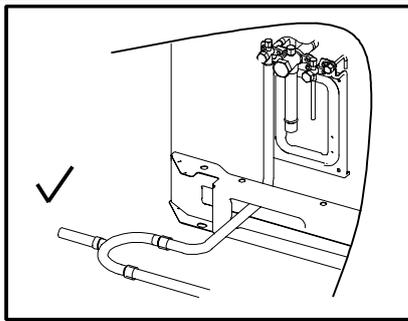

## 5. Drainage pipe engineering

### 5.1 Installation highlights of drainage pipe

#### 5.1.1 Installation principle of drainage pipe

1) Slope; 2) reasonable pipe diameter; 3) nearby discharge

#### 5.1.2 Installation highlights of drainage pipe

1. Before installing condensate water pipeline, determine its route and elevation to avoid intersection with other pipelines and ensure slope is smooth and straight.

2. Make sure that the two horizontal fluid pipes shall avoid encountering, and preventing flow backwards and drainage difficulty.

a. Correct connection:

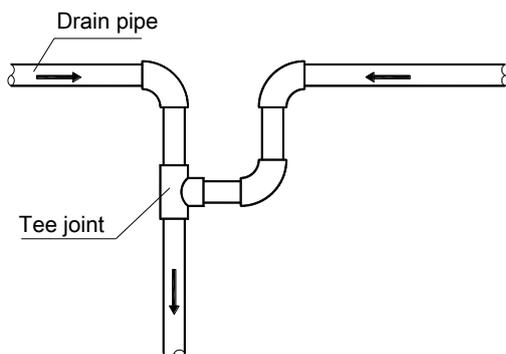

OK

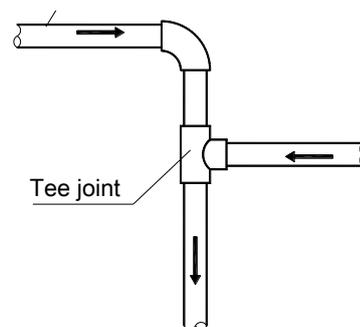

OK

b. Incorrect connection:

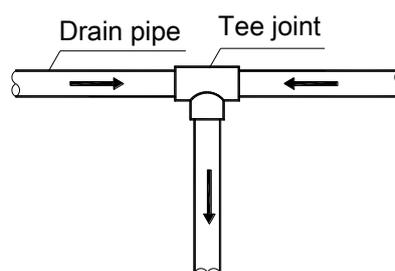

X

**Advantages of correct connection:**

1. Do not cause flow backwards of one pipe.
2. The slope of two pipes can be regulated separately.

**Disadvantages of incorrect connection:**

1. Interfere drainage.
2. The side of branch pipe with large quantity of fluid volume will flow to the side with small quantity, thus leading to the water backwards of branch pipe with small quantity.

**3. Suspender gap:**

In general, the horizontal gap is 0.8m-1m and the vertical gap is 1.5m-2.0m. Each vertical pipe shall be equipped with not less than two suspenders. Overlarge suspender gap for horizontal pipe shall create bending, thus leading to air resistance.

4. The highest point of drainage pipe shall be designed with air hole to ensure that condensate water could be discharged smoothly. The outlet air hole shall face down to prevent dirt entering pipe.
5. After finishing connection, conduct water passing test and overflowing water test to pipelines to check the smoothness of drainage and leakage of pipeline system.
6. Use specific glue to adhesive the seam of thermal insulation materials, and then bind with rubber or plastics adhesive tape. The width of the adhesive tape shall not be less than 50mm to ensure fastness and prevent condensation.
7. The drainage pipe of air conditioner shall be installed separately with other waste pipe, rainwater pipe and other drainage pipe in building.
8. The slope of drainage pipe shall be kept above 1/100.

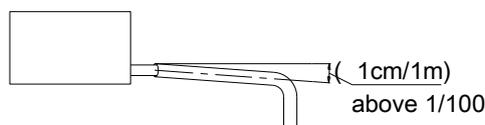

9. In case 1/100 slope cannot need, consider to use larger-sized pipe and use its diameter to create slope.
10. Conflux towards horizontal pipe shall come from upside as much as possible. If it comes from transverse route, reflux is easy to be created.
11. The end of drainage pipe shall not contact with ground directly.

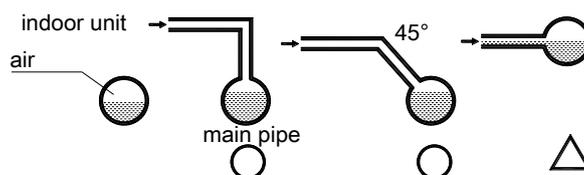
**Caution**

1. The drainage pipe diameter shall meet the draining requirement of indoor unit.
2. The outlet air vent cannot be installed nearby the lifting pump of the indoor unit.
3. Check whether condensate water pump can be started up and shut down normally by infusing water into the water-containing plate of indoor unit and powering on.
4. All joints shall be firm (particularly PVC pipe).
5. The drainage pipe is not allowed to turn to adverse slope, horizontal, and bending.
6. Dimension of drainage pipe shall be not less than the connecting mouth size of drain piping to indoor unit.
7. Work out thermal insulation of drainage pipe, otherwise it is easy to produce condensation. Thermal insulation processing shall be continued to the connecting part of indoor unit.
8. Indoor units with different draining pattern shall not share the same concentrated drainage pipe.
9. Discharge of condensate water cannot influence normal life and working of other people.
10. As for long drainage pipe, hanging bolt shall be used to ensure 1/100 slope without bending PVC pipe.

※ The support gap of horizontal pipe is 0.8-1.0mm. If the gap is too large, it shall produce bending and air resistance, while air resistance could seriously influence smoothness of water flow to cause abnormal water level. As shown in following figure:

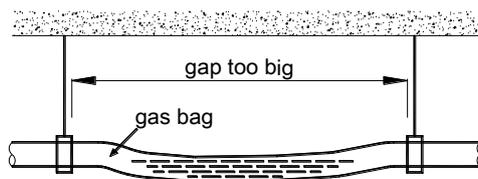

### 5.2 Water storing elbow of drainage pipe

To indoor unit with large negative pressure at the outlet of water-containing plate, the drainage pipe must be equipped with water storing elbow.

#### Function of water storing elbow:

When indoor unit is in motion, prevent generating negative pressure to cause drainage difficulty or blow water out of the air outlet.

#### Installation of water storing elbow:

1. Install water storing elbow as shown in following figure: H shall be above 50mm.
2. Install one water storing elbow for each unit.
3. When installation, consider it shall be convenient in future clean.

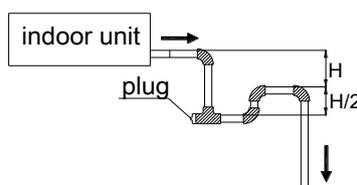

### 5.3 Concentrated drainage pipe

#### 5.3.1 Pipeline diameter of concentrated drainage pipe

Select drainage pipe diameter according to indoor unit's combined flow volume.

E.g. If one 1HP unit with 2L/h discharging condensate water, the calculation of the combined flow volume of three 2HP units and two 1.5HP units is:  $2HP \times 2L/h \times 3 + 1.5HP \times 2L/h \times 2 = 18L$

#### 5.3.2 Relation between horizontal pipeline diameter and permitted displacement of condensate water

PVC piping	Inner diameter of piping(reference value: in.(mm))	Inner diameter of piping (in.(mm))	Permitted displacement(1/h)		Remark
			Slope 1:50	Slope 1:100	
PVC25	3/4(19)	25/32(20)	39	27	(Reference value)could not be used for confluence pipe
PVC32	1-1/16(27)	63/64(25)	70	50	
PVC40	1-11/32(34)	1-7/32(31)	125	88	Could be used for confluence pipe
PVC50	1-47/64(44)	1-37/64(40)	247	175	
PVC63	2-13/64(56)	2-1/64(51)	473	334	

Attention: through converge point need use PVC40 or larger pipe.

#### 5.3.3 Relation between vertical pipeline diameter and displacement of condensate water

PVC piping	Inner diameter of piping(reference value: in.(mm))	Inner diameter of piping (in.(mm))	Permitted displacement(1/h)	Remark
PVC25	3/4(19)	25/32(20)	220	(Reference value)could not be used for confluence pipe
PVC32	1-1/16(27)	63/64(25)	410	
PVC40	1-11/32(34)	1-7/32(31)	730	Could be used for confluence pipe
PVC50	1-47/64(44)	1-37/64(40)	1440	
PVC63	2-13/64(56)	2-1/64(51)	2760	
PVC75	2-19/32(66)	2-41/64(67)	5710	
PVC90	3-7/64(79)	3-1/32(77)	8280	

Attention: through converge point need use PVC40 or larger pipe.

### 5.3.4 Operation process of concentrated drainage

Install indoor unit → connect drainage pipe → water passing test and overflowing water test → thermal insulation of drainage pipe

Caution:

- 1) Increase drainage point as much as possible and reduce quantity of connected indoor units, to ensure horizontal main drainage pipe not be too long.
- 2) Units with drainage pump and natural drainage shall converge to different drainage system separately.
- 3) Add two elbows at air outlet, and make sure its mouth faces down to prevent dirt and so on dropping into pipe to create blockage.

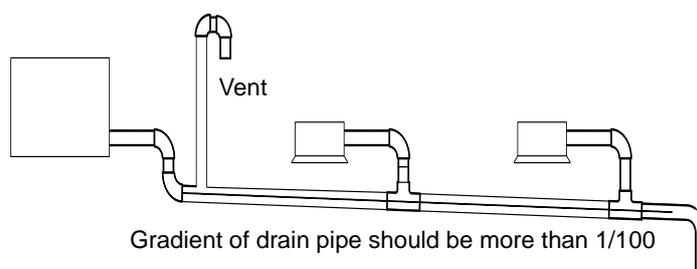

### 5.4 Lifting of drainage pipe (for the unit with lift pump)

#### Installation of lift pipe

1. When connecting drainage pipe with indoor unit, use pipe clamp shipped with unit to fix. Glue splicing is not permitted for ensuring convenience in repairing.
2. To ensure 1/100 slope, total lift height of drainage pipe (H) shall depend on indoor unit's pump, and do not set vent pipe on the lifting pipe section. After lifting vertically, immediately place down inclined, otherwise it will cause error operation of switch at water pump. The connecting method is shown as follows:

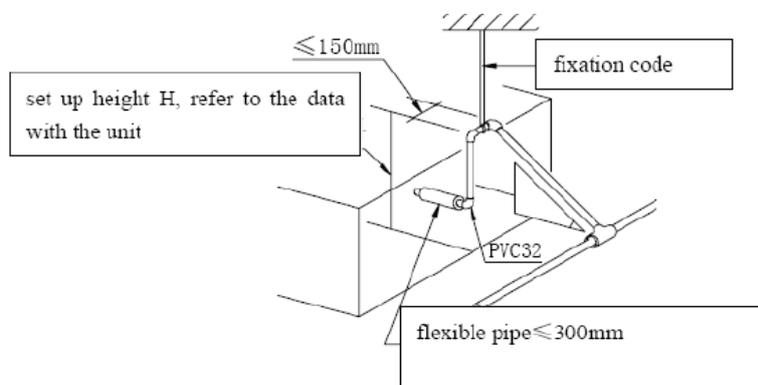

Note: Air outlet could not be installed on the lifting part; otherwise water shall be discharged to ceiling or could not be discharged.

### 5.5 Overflowing water test and water passing test

#### 5.5.1 Overflowing water test

After finishing the construction of drainage pipe system, fill the pipe with water and keep it for 24 hours to check whether there is leakage at joint section.

#### 5.5.2 Water passing test

##### 1. Natural drainage mode

Infuse water-containing plate with above 600ml water through check port slowly, and observe transparent hard pipe at drainage outlet to confirm whether it can discharge water.

##### 2. Pump drainage mode

- 1) Remove plug of water level switch, remove water-finding cover and slowly infuse water-containing plate with about 2000ml water through water-finding port to prevent touching the motor of drainage pump.



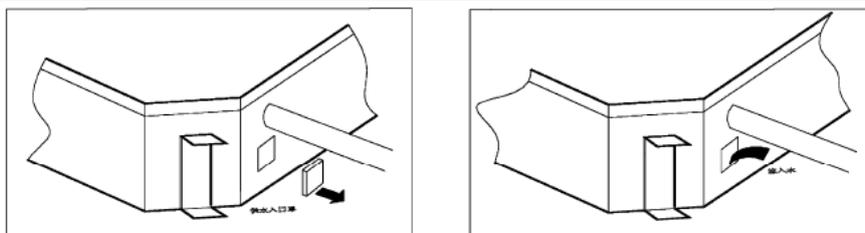

2) Power on and let the air conditioner operate for cooling. Check operation status of drainage pump, and then turn on water level switch, check operation sound of pump and observe transparent hard pipe at drainage outlet to confirm whether it can discharge water. (In light of the length of drainage pipe, water shall be discharged after delaying about 1 minute)

3) Stop the operation of air conditioner, turn down power supply and put water-finding cover to the original place.

a. After stopping the operation of air conditioner, check whether there is something abnormal 3 minutes later. If drainage pipe have not been distributed properly, over back-flow water shall cause the flashing of alarm indicator at remote-controlled receiving board and even water shall run over the water-containing plate.

b. Continuously add water until reaching alarm water level, check whether the drainage pump could discharge water at once. If water level does not decline under warning water level 3 minutes later, it shall cause shutdown of unit. When this situation happens, normal startup shall be carried out by turning down power supply and eliminating accumulated water.

**Note:** Drain plug at the main water-containing plate is used for eliminating accumulated water in water-containing plate when maintaining air conditioner fault. During normal operation, the plug shall be filled in to prevent leakage.

## 6. Duct engineering

### 6.1 Fabrication of duct

1. The material, specification, performance and thickness of metal duct should be in accordance with the relevant regulations of present National Products Standard. The thickness of steel sheet or galvanized steel sheet should not be less than the regulation in table below:

Thickness of steel sheet duct

Diameter(D) or edge length (b) of duct (in.(mm))	Circular duct (in.(mm))	Rectangle duct (in.(mm))	
		Middle/low pressure system	High pressure system
$D(b) \leq 12-19/32(320)$	0.02(0.5)	0.02(0.5)	0.03(0.75)
$12-19/32(320) < D(b) \leq 17-23/32(450)$	0.024(0.6)	0.024(0.6)	0.03(0.75)
$17-23/32(450) < D(b) \leq 24-51/64(630)$	0.03(0.75)	0.024(0.6)	0.03(0.75)
$24-51/64(630) < D(b) \leq 39-3/8(1000)$	0.03(0.75)	0.03(0.75)	0.04(1)
$39-3/8(1000) < D(b) \leq 1250$	0.04(1)	0.04(1)	0.04(1)

2. The material, specification, performance and thickness of non-metal duct should be in compliance with design and regulations of present National Products Standard.

3. The body, frame, fixing material and sealed cushion of fire-proof air duct should be made of non-combustible materials. Its fire resistance rating should be in accordance with the design requirement.

4. The sheathing of composite duct should be made of non-combustible materials. Inner insulation material should be no burning or burning retardant with rating B1, and no harm to people's body.

5. The permitting deviation to outer diameter or long edge of duct: when less than 11-13/16"(300mm), it is 0.08"(2mm); when more than 11-13/16"(300mm), it is 0.12"(3mm). The permitting deviation of pipe end flatness is 0.08"(2mm).

Discrepancy between two diagonal lines of rectangle duct shall not be more than 0.12"(3mm). Discrepancy between two diameters of any cross-cut circular flange shall not be more than 0.08"(2mm).

### 6.2 Connection of Duct

### 1. Connection of metal duct

- 1) The seam of duct board splice should be stagger and cross-seam is not allowed.
- 2) Specification of metal duct flange shall not be less than the data as shown in table below.

#### Specification to flange and bolt of circular metal duct

Diameter of duct(D) (in.(mm))	Specification of flange (in.(mm))		Specification of bolt
	Flat steel	Angle steel	
$D \leq 5-33/64(140)$	25/32x5/32(20x4)	-	M6
$5-33/64(140) < D \leq 11-1/32(280)$	1x5/32(25x4)	-	
$11-1/32(280) < D \leq 24-51/64(630)$	-	1x1/8 (25x3)	
$24-51/64(630) < D \leq 49-7/32(1250)$	-	1-3/16x5/32(30x4)	M8
$49-7/32(1250) < D \leq 78-47/64(2000)$	-	1-37/64x5/32(40x4)	

#### Specification to flange and bolt of rectangle metal duct (mm)

Dimension of long edge of duct(b) (in.(mm))	Specification of flange(angle steel) (in.(mm))	Specification of bolt
$b \leq 24-51/64(630)$	1x1/8 (25x3)	M6
$24-51/64(630) < b \leq 59-1/16(1500)$	1-3/16x1/8(30x3)	M8
$59-1/16(1500) < b \leq 98-27/64(2500)$	1-37/64x5/32(40x4)	
$98-27/64(2500) < b \leq 157-31/64(4000)$	1-31/32x13/64(50x5)	M10

- 3) Diameter of bolt and rivet to duct flange for middle/low pressure system should be no more than 5-29/32”(150mm).

As for duct of high pressure system, it should be no more than 3-15/16”(100mm).

- 4) Four angles of rectangle duct flange should be designed with screw hole.
- 5) When improving the strength of duct flange position by adopting reinforcement method, the applied condition corresponding to flange specification could be extended.

### 2. Connection of nonmetallic duct

Specification of flange should be in accordance with standard, gap of bolt hole should be no more than 4-23/32”(120mm). Four angles of rectangle duct flange should be designed with screw hole.

### 3. Strengthening of metal duct

When edge length of rectangle duct is more than 630mm, edge length of insulation duct is more than 31-1/2”(800mm) and length of pipe section is more than 49-7/32”(1250mm), or single-edge level area of low pressure duct is more than 1.2 square meters and single-edge level area of high/middle pressure duct is more than 1.0 square meter, strengthening measures should be conducted.

### 4. Strengthening of nonmetallic duct

When diameter or edge length of HPVC duct is more than 19-11/16”(500mm), the joint section of duct and flange should be equipped with strengthening board and the gap should not be more than 17-23/32”(450mm).

## 6.3 Connecting Highlights of Duct

1. Supporting, hanging and mounting bracket should be made of angle steel. Position of expansion bolt should be correct, firm and reliable. The buried part could not be painted and oil pollution should be eliminated. Gap should be in accordance with regulation below:

- 1) If duct is installed horizontally, gap should be no more than 13.1ft.(4m) when diameter or edge length is less than or equal to 1.3ft.(400mm), while the gap should be no more than 9.8ft.(3m) when diameter or edge length is more than 1.3ft.(400mm).

- 2) If duct is installed vertically, gap should be no more than 13.1ft.(4m) and make sure there is at least 2 fixed points on single straight pipe.

2. Supporting, hanging and mounting bracket could not be installed at air opening, valve, checking door and automatically controlled device, and distance to air opening or plugged tube shall not be less than 0.66ft.(200mm).

3. Hanging bracket should not be hung above flange.

4. Thickness of flange gasket should be 0.12-0.2"(3-5mm). Gasket should be flat on flange and inserting to pipe is not allowed. Set up fixed points at proper place for hanging pipe to prevent vibration.
5. Vertical splice seam of duct should be stagger. Make sure there is no vertical seam at the bottom of duct installed horizontally. As for the installation of flexible short duct, keep proper tightness and no distortion.
6. All metal parts (including supporting, hanging and mounting bracket) on pipeline system engineering should be conducted anti-corrosion treatment.

#### 6.4 Installation of Assembly

1. The regulating device of duct should be installed in place where is easy to operate, flexible and reliable.
2. The air port should be installed firmly and air pipe should be connected tightly. Frame should be tightly contact with decorate of building. The appearance should be smooth and flat, and regulation is flexible.
3. If air port is installed horizontally, deviation of levelness is no more than 3/1000. If air port is installed vertically, deviation of perpendicular should be no more than 2/1000.
4. The same air port in same room should be installed at the same height, and put in order

### 7. Heat Insulation Engineering

The insulation of refrigerating equipment and pipe is carried out through general insulation method, which binding the equipment and pipe with solid multi-hole insulation material and exploiting proper wet-proof and protection measures, called insulation structure. The form of insulation structure shall be different in light of different insulation materials. This is a traditional insulation method which is adopted very early. Although its insulation performance is general, but it is simply in structure, convenient in construction and cheap in price, so that it is widely used in refrigeration engineering.

#### 7.1 Insulation of Refrigerant Piping

##### 7.1.1 Operational procedure of refrigerant piping insulation

Construction of refrigerant pipe → insulation (excluding connecting section) → test for air sealing → connecting section insulation

**Connecting section:** for instance, insulation construction just could be carried out after air tightness test at welding area, opening expending area and flange joint is successful.

##### 7.1.2 Purpose of refrigerant piping insulation

1. During operation, temperature of gas pipe and liquid pipe shall be over-heating or over-cooling extremely. Therefore, it is necessary to carry out insulation; otherwise it shall reduce the performance of unit and burn compressor.
2. Gas pipe temperature is very low during cooling. If insulation is not enough, it shall form dew and cause leakage.
3. Temperature of outlet pipe (gas pipe) is very high (generally 122-212°F(50-100°C) during heating. Touching due to carelessness shall cause hurt, so it is necessary to take insulation measures to avoid getting hurt.

##### 7.1.3 Selection of insulation materials for refrigerant piping

Adopt hole-closed foam insulation materials with level B1of burning retardant and over 248°F(120°C) of constant burning performance.

##### 7.1.4 Thickness of insulation layer

1. When outer diameter of copper pipe (d) is less than or equal to 1/2"(12.7mm), the thickness of insulation layer (δ) shall be above 19/32"(15mm).

When outer diameter of copper pipe (d) is more than or equal to 5/8"(15.88mm), the thickness of insulation layer (δ) shall be above 25/32"(20mm).

2. In hot and wet environment, the above recommended value shall be increased one time.

**Note:** The outdoor pipeline shall be protected by metal case to proof sunshine, storm and air erosion, and prevent damage of external force or man-made destroy.

##### 7.1.5 Installation and highlights of insulation construction

1. Example of wrong operation: Gas pipe and liquid pipe are carried out insulation together; causing the operation effect of air conditioner is bad.

2. Example of correct operation:

a. Gas pipe and liquid pipe are carried out heat insulation separately.

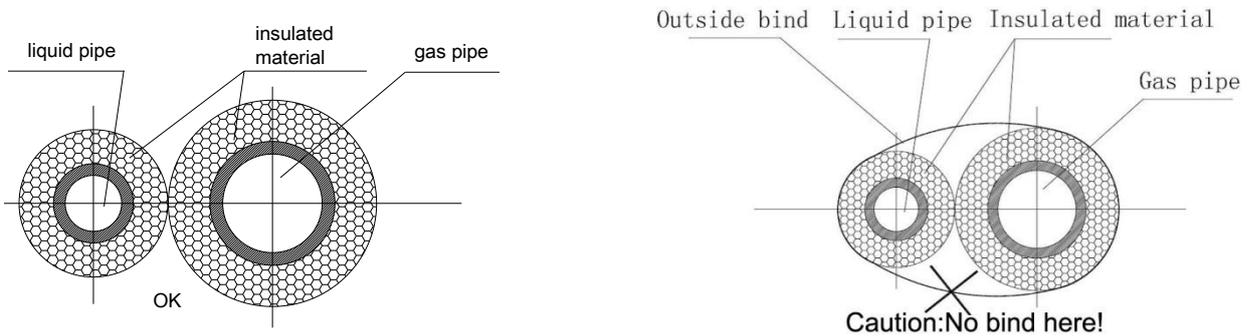

**Note:** After gas pipe and liquid pipe are carried out heat insulation separately, bind with tape. If it is bound over tightly, the spliced insulation joint shall be damaged.

b. The surrounding of pipe connecting section shall be carried out insulation entirely.

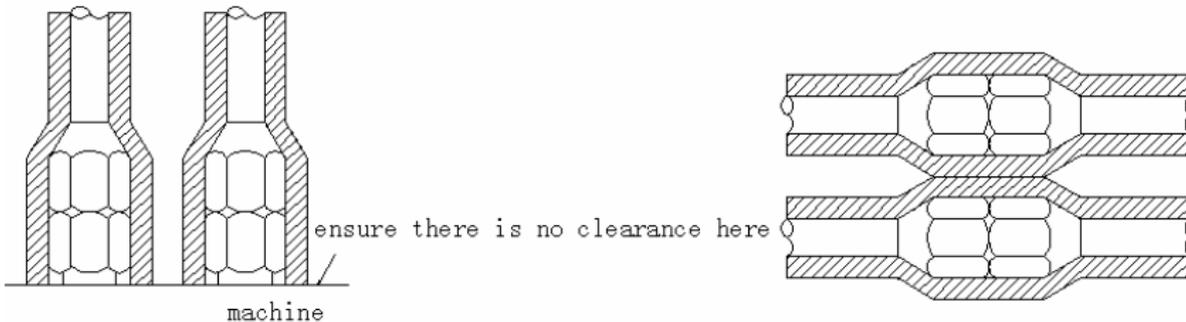

**Highlights:**

1. No gap in joint of insulation materials.
2. If the joint of insulation materials is linked tardily and tape is bound over tightly, shrinkage and leakage shall be produced easily to create phenomena of dew-drop. The over-tightened tape shall edge out air in material, leading to decrease the insulation effect at this part; meanwhile tape shall be easily aged and drop down.
3. In indoor shield space, it is no necessary to bind belting, so as to avoid influencing insulation effect.

Correct repairing method for insulation cotton: (see the figure below)

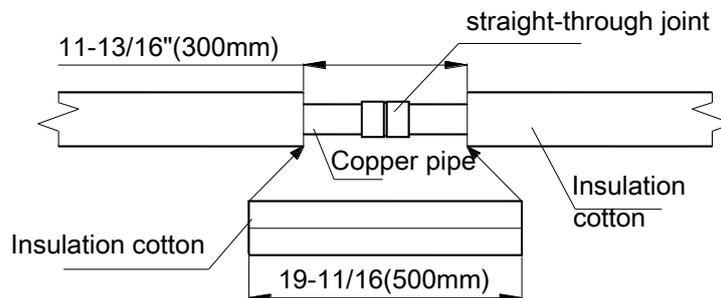

Firstly cut out the material longer than gap, expend the two ends and embed the insulated cotton, at last, paste joint with glue.

**Highlights of insulation repairing:**

1. Repaired length of insulation (insulation tube with filled gap) shall be 1-31/32~3-15/16\"/>
- 2. Sliver the cut of insulation to be repaired and cross-section shall be even.
- 3. Insert gap with insulation for repairing and cross-section shall be pressed tightly.
- 4. All cross-section and cut need to be pasted with glue.

5. Finally, bind the seam with rubber/plastic tape.
6. Prohibit conducting insulation by using binder fabric in concealed section, so as to avoid influencing insulation effect.

### 7.2 Insulation of Condensate Water Pipe

1. Select rubber/plastic tube with burning retardant of rating B1.
2. Thickness of insulation layer is usually above 10mm.
3. The insulation material at water outlet of unit body should be pasted with glue on the unit body, so as to avoid dewing and dripping.
4. Pipe installed in wall shall not be conduct insulation.
5. Use specific glue to paste the seam of insulation material, and then bind with cloth tape. The width of tape shall not be less than 1-31/32"(50mm). Make sure it is firm and avoid dewing.

### 7.3 Insulation of Duct

1. Insulation of duct
  - 1) Insulation of duct parts and equipment should be conducted after confirming that the leakage test and quality of duct is qualified.
  - 2) Usually making use of centrifugal glass cotton, rubber/plastic material or other late-model insulation duct to conduct insulation.
2. Insulation layer should be even and tight. Crack, gap and other defects are not allowed.
3. The supporting, hanging and mounting bracket of duct should be set up to the outside of insulation layer, and insert bed timber between bracket and duct.
4. Thickness of insulation layer
  - 1) As for the inlet and outlet duct installed in room free of air conditioner, the thickness of insulation layer should be above 1-37/64"(40mm) when adopting centrifugal glass cotton for insulation.
  - 2) As for the inlet and outlet duct installed in room with air conditioner, the thickness of insulation layer should be above 1"(25mm) when adopting centrifugal glass cotton for insulation.
  - 3) When adopting rubber/plastic material and other materials, the thickness of insulation layer should be come out in accordance with design requirement or calculation.

## 8. Caution for brazing

- Make sure to blow through with nitrogen when brazing. Blowing through with nitrogen prevents the creation of large quantities of oxidized film on the side of the pipe. An oxidized film adversely affects valves and compressors in the refrigerating system and prevents proper operation.
- The nitrogen pressure should be set to 2.9PSI(0.02MPa) (just enough so it can be felt on the skin) with a pressure-reducing valve.

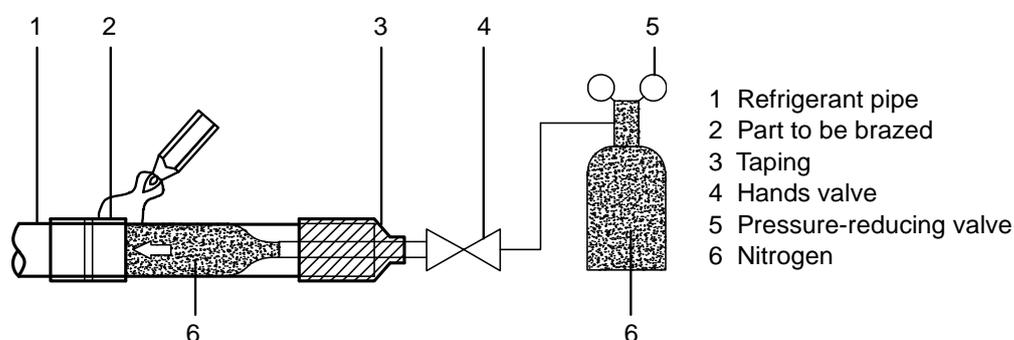

- Do not use anti-oxidants when brazing the pipe joints. Residue can clog pipes and break equipment.
- Do not use flux when brazing copper-to-copper refrigerant piping. Use phosphor copper brazing filler alloy (BCuP) which does not require flux.

- Flux has an extremely harmful influence on refrigerant pipe systems. For instance, if chlorine based flux is used, it will cause pipe corrosion in particular, if the flux contains fluorine, it will deteriorate the refrigerant oil.

## 9. Remove dirt or water in the piping

- Make sure there is no any dirt or water in the pipe before connecting the piping to the outdoor units.
- Wash the piping with high pressure nitrogen, never use refrigerant of the outdoor unit to do that.

## 10. Gas tightness test

### 10.1 Purpose and operation procedure of air tightness test

#### 10.1.1 Purpose

Search leak source, make sure there is no leakage in system to prevent system fault due to leakage of refrigerant.

#### 10.1.2 Operation tips

Subsection detection, overall pressure-keeping, grading pressurization.

#### 10.1.3 Operation procedure

- After piping of indoor unit has been connected, weld port of high-pressure side piping.
- Weld low-pressure side piping with connector for pressure gauge together.
- Charge nitrogen slowly into pressure gauge connector to conduct air tightness test.

### 10.2 Operation of air tightness test

#### 10.2.1 Operation procedure

- When conducting air tightness test, make sure that gas pipe and liquid pipe are kept in full-shut status; otherwise, nitrogen might enter the circulation system of outdoor unit. Both gas valve and liquid valve need to be strengthened before pressurization d.
- Each refrigerant system shall be slowly pressurized from the two sides of gas pipe and liquid pipe.
- Make use of dry nitrogen as medium to conduct air tightness test. Phase-in control diagram of pressurization is as follows:

No.	Phase (phase-in pressurization)	Criteria
1	Phase 1: appear large leakage after over three minutes of pressurization with 42.6PSI(3.0kgf/cm <sup>2</sup> ).	No pressure drop after modification
2	Phase 2: appear major leakage after over three minutes of pressurization with 213.3PSI(15.0kgf/cm <sup>2</sup> ).	
3	Phase 3: appear small leakage after over 24 hours of pressurization with R410A: 568.8PSI(40.0kgf/cm <sup>2</sup> ).	

#### 10.2.2 Pressure observation

- Pressurize to regulated value and maintain 24 hours. When modifying pressure according to variation of temperature, it is qualified if pressure drop does not happen. If pressure falls, find out the leak source and modify it.

#### 2. Modification method

When ambient temperature difference is  $\pm 1.8^{\circ}\text{F}(1^{\circ}\text{C})$ , the pressure difference shall be  $\pm 1.4\text{PSI}(0.1\text{kgf}/\text{cm}^2)$ .

Modification formula: Real value = pressure of pressurization + (temperature of pressurization – temperature during observation) $\times 1.4\text{PSI}(0.1\text{kgf}/\text{cm}^2)$

You can find out whether the pressure drops or not by comparing the modification value with pressurization value.

#### 3. General ways for searching leak source

Conduct detection through three phases; find out leak source when pressure drop happens.

- Audition detection-----hear large leakage sound
- Hand-touching detection-----place hand at the joint of pipeline to feel whether there is leakage

3) Soap water detection-----bubbles shall burst out from leak source.

4) Detection by use of halogen leak detector

Using halogen leak detector when finding out pressure drop but not finding the leak source.

a. Keep nitrogen at 42.6PSI(3.0kgf/cm<sup>2</sup>).

b. Supplement refrigerant to 71.1PSI(5.0kgf/cm<sup>2</sup>).

c. Use halogen leak detector, methane leak detector and electric leak detector for detection.

d. If the leak source still could not be found, continuously pressurize to 568.8PSI(40.0kgf/cm<sup>2</sup>) (R410A) and then detect again.

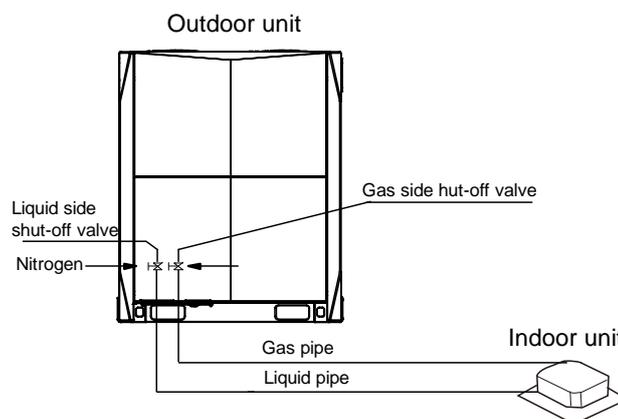

#### 4. Caution

1) The air tightness test is conducted by pressurize nitrogen (R410A system: 568.8PSI(40.0kgf/cm<sup>2</sup>)).

2) It is not allowed to adopt oxide, flammable gas and toxic gas to conduct air tightness test.

3) Before pressure-keeping reading, let it rest for several minutes till pressure is stable, to record temperature, pressure value for future modification.

4) After pressure-keeping is over, release system pressure to 71.1~113.7PSI(5~8kgf/cm<sup>2</sup>) and then conduct pressure-keeping and storage.

5) If pipeline is too long, conduct phase-in detection.

a. Inner side of pipeline

b. Inner side of pipeline + upright

c. Inner side of pipeline + upright+ outer side of pipeline

## 11. Vacuum Drying

### 11.1 Purpose and highlights of vacuum drying

#### 11.1.1 Purpose of vacuum drying

1. Dehumidify the system to prevent ice-blockage and copperizing. Ice-blockage shall cause abnormal operation, while copperizing shall damage compressor.

2. Eliminating the non-condensable gas of system to prevent oxidizing components, system pressure fluctuation, and bad heat exchanging during the system operation.

3. Detect leak source from reverse rotate.

#### 11.1.2 Selection of vacuum pump

1. The limit of vacuum degree is below -14.6PSI(756mmHg).

2. The discharge of vacuum pump is over 4L/s.

3. The precision of vacuum pump is over 0.001ft.H<sub>2</sub>O(0.02mmHg).

#### Highlights of R410A system:

After the vacuum process of R410A refrigerant circulation is over, vacuum pump stops running and the lubricant in vacuum pump shall flow back to air conditioning system, for the inner of pump soft pipe is in vacuum status. In addition, same situation shall happen if vacuum pump suddenly stops during operation. At this moment, different oils will mix, which induce the refrigerant circulating system to malfunction, so it is

recommended to use one-way valve to prevent reverse flow of oil in vacuum pump.

### 11.1.3 Vacuum drying for pipe

Vacuum drying: Use vacuum pump to make the moisture (liquid) in pipeline change into steam, which will eliminate the moist of the pipeline and keep drying of pipe inner. Under atmospheric pressure, water's boiling point (steam temperature) is 212°F(100°C), while its boiling point will decline when using vacuum pump reduce the pipeline pressure to vacuum. When the boiling point declines under outdoor temperature, moisture in pipe shall be evaporated.

Boiling Point of Water (°F(°C))	Air Pressure (PSI(mmHg))	Vacuum Degree (PSI(mmHg))	Boiling Point of Water (°F(°C))	Air Pressure (PSI(mmHg))	Vacuum Degree (PSI(mmHg))
104(40)	1.06(55)	-13.6(-705)	64(17. 8)	0.3(15)	-14.4(-745)
86(30)	0.7(36)	-14(-724)	59(15)	0.25(13)	-14.44(-747)
80(26. 7)	0.5(25)	-14.2(-735)	53.1(11. 7)	0.2(10)	-14.5(-750)
76(24. 4)	0.45(23)	-14.25(-737)	45(7. 2)	0.16(8)	-14.54(-752)
72(22. 2)	0.4(20)	-14.3(-740)	32(0)	0.1(5)	-14.6(-755)
69.1(20. 6)	0.35(18)	-14.35(-742)			

## 11.2 Operation procedure for vacuum drying

### Methods of vacuum drying

By different construction environment, there are two kinds of vacuum drying ways: ordinary vacuum drying and special vacuum drying.

#### 11.2.1 Ordinary vacuum drying

- 1) Firstly, connect the pressure gauge to the infusing mouth of gas pipe and liquid pipe, keep vacuum pump running for above 2 hours, and it is quality that vacuum degree of vacuum pump is below -14.6PSI(-755mmHg).
- 2) If the vacuum degree of vacuum pump could not be below -14.6PSI(-755mmHg) after 2 hours of drying, system will continue drying for one hour.
- 3) If the vacuum degree of vacuum pump could not be below -14.6PSI(-755mmHg) after 3 hours of drying, please check the system leakage source.
- 4) Vacuum placement test: when the vacuum degree reaches -14.6PSI(-755mmHg), keep rest for 1 hour. If the indicator of vacuum gauge does not go up, it is qualified. If going up, it indicates that there is moisture and leak source.
- 5) Vacuum drying shall be conduct from liquid pipe and gas pipe simultaneously. There are a lot of functional parts like valves, which could shut down the gas flow midway.

#### 11.2. 2 Special vacuum drying

This kind of vacuum drying method shall be adopted when:

- 1) Finding moisture during flushing refrigerant pipe.
- 2) Conducting construction on rainy day, because rain water might penetrated into pipeline.
- 3) Construction period is long, and rain water might penetrated into pipeline.
- 4) Rain water might penetrate into pipeline during construction.

Procedures of special vacuum drying are as follows:

- a. The first vacuum drying 2 hours.
- b. The second vacuum damage, filling nitrogen to 7.1PSI(0.5kgf/cm<sup>2</sup>).

Because nitrogen is dry gas, vacuum damage could achieve the effect of vacuum drying, but this method could not achieve drying thoroughly when there is too much moisture. Therefore, special attention shall be drawn to prevent the entering of water and the formation of condensate water.

- c. The second vacuum drying 1 hour.

It is qualified when vacuum degree is under -14.6PSI(-755mmHg); if the vacuum degree is still above



-14.6PSI(-755mmHg) within 2 hours drying, please repeat the procedures of “vacuum damage---vacuum drying”.

d. Vacuum placement test: when the vacuum degree reaches -14.6PSI(-755mmHg), keep rest for 1 hour. If the indicator of vacuum gauge does not go up, it is qualified. If going up, it indicates that there is moisture and leak source.

## 12. Additional refrigerant charge

### 12.1 Operation procedure for recharging refrigerant

#### 12.1.1 Operation procedure

Calculate the required refrigerant volume by the length of liquid pipe → recharging refrigerant.

※The refrigerant volume from factory does not include the recharged amount of the pipeline extending.

#### 12.1.2 Detailed steps for recharging refrigerant

1. Make sure vacuum drying is qualified before recharging refrigerant.
2. Calculate the required refrigerant volume by the diameter and the length of liquid pipe.
3. Use electronic scale or fluid infusion apparatus to weight the recharged refrigerant volume.
4. Use soft pipe to connect refrigerant cylinder, pressure gauge, and examine valve of outdoor unit. And recharge with liquid mode. Before recharging, eliminate the air in the soft pipe and pressure gauge's pipe.
5. After finishing the recharging, by the gas leak detector or soap water, to detect whether there is refrigerant leakage in expansion part of indoor and outdoor units.
6. Write the recharged refrigerant volume in the indicating plate of outdoor unit.

#### Caution

- 1) The recharged refrigerant volume must be calculated according to the formula in the technical reference of outdoor unit. It isn't allowed to calculate by running current, pressure and temperature. Because current and pressure is changeable due to the difference of temperature and length of pipeline.
- 2) In the cold ambient, use warm water and hot wind to warm up refrigerant storage cylinder, and don't allow heating up directly by flame.

#### 12.1.3 Recharging R410A refrigerant

If R410A refrigerant is adopted, the tool shall be different. Confirm the following items before Recharged:

- 1) The different vacuum pump with one-way valve.
- 2) The different pressure gauge: the nut of connector and pressure scale are different.
- 3) The different recharging soft pipe and connector.
- 4) The charging method is different. Recharge into the outdoor unit with liquid phase.
- 5) The different leak detector.

### 12.2 Calculating the recharged refrigerant volume

Calculate the additional refrigerant charge according to the diameter and the length of the liquid side pipe of the outdoor/indoor unit connection. The refrigerant is R410A.

Note: Assume equivalent pipe length of the branch joint is 0.5m (for calculation purposes).

Pipe size of liquid side ( in.(mm))	Additional refrigerant charge per meter (kg)
Φ1/4(6.35)	0.022
Φ3/8(9.53)	0.057
Φ1/2(12.7)	0.110
Φ5/8(15.9)	0.170
Φ3/4(19.1)	0.260
Φ7/8(22.2)	0.360
Φ1(25.4)	0.520
Φ1-1/8(28.6)	0.680

- Charge the additional refrigerant from the gas pipe or liquid pipe. After the system is running, if it is needed to charge refrigerant during maintenance, charge at the gauge point.
- **Calculating formula (R410A):**
- The recharged volume:  $R \text{ (kg)} = (L1 \times 0.022 \text{ kg/m}) + (L2 \times 0.057 \text{ kg/m}) + (L3 \times 0.110 \text{ kg/m}) + (L4 \times 0.170 \text{ kg/m}) + (L5 \times 0.260 \text{ kg/m}) + (L6 \times 0.360 \text{ kg/m}) + (L7 \times 0.520 \text{ kg/m}) + (L8 \times 0.680 \text{ kg/m})$
- L1: Actual total length of Φ6.35 liquid pipe (m); L2: Actual total length of Φ9.53 liquid pipe (m);
- L3: Actual total length of Φ12.7 liquid pipe (m); L4: Actual total length of Φ15.9 liquid pipe (m);
- L5: Actual total length of Φ19.1 liquid pipe (m); L6: Actual total length of Φ22.2 liquid pipe (m);
- L7: Actual total length of Φ25.4 liquid pipe (m); L8: Actual total length of Φ28.6 liquid pipe

### 13. Electric wiring installation

#### 13.1 Wiring terminals instruction

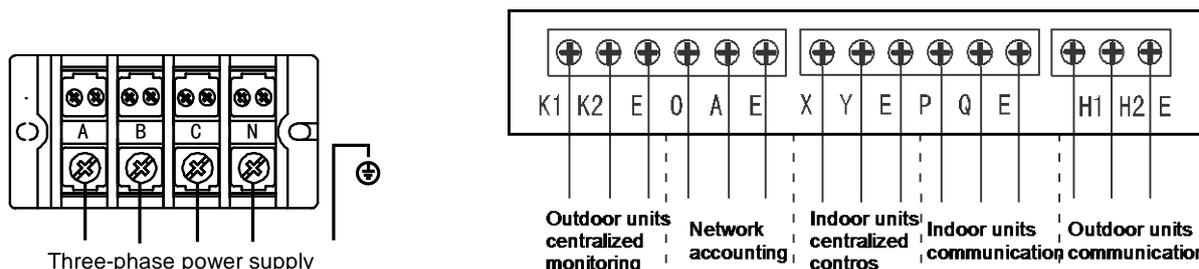

#### 13.2 Electric characteristics

Model	Units				Power supply			Compressor		OFM	
	Hz	Voltage (V)	Min. (V)	Max. (V)	MCA (A)	TOCA (A)	MFA (A)	MSC (A)	RLA (A)	kW	FLA (A)
MVD-V5X252W/V2GN1	50/60	380~415	342	440	17.8	22.8	25	-	14.58	0.465	4.6
MVD-V5X280W/V2GN1	50/60	380~415	342	440	20.3	22.8	25	-	14.58	0.465	4.6
MVD-V5X335W/V2GN1	50/60	380~415	342	440	21.9	23.7	25	-	15.62	0.465	4.5
MVD-V5X400W/V2GN1	50/60	380~415	342	440	29	29.8	35	-	10.23+10.23	0.29+0.23	2.8+2.4
MVD-V5X450W/V2GN1	50/60	380~415	342	440	30.1	29.8	35	-	10.23+10.23	0.29+0.23	2.8+2.4
MVD-V5X500W/V2GN1	50/60	380~415	342	440	36.3	37.9	40	-	15.62+9.36	0.42+0.35	3.9+3.5
MVD-V5X560W/V2GN1	50/60	380~415	342	440	42.8	48.3	50	-	15.62+15.62	0.44+0.35	4.0+3.4
MVD-V5X615W/V2GN1	50/60	380~415	342	440	46.4	48.3	50	-	15.62+15.62	0.44+0.35	4.0+3.4

The current value of combination unit is the total value of each basic model(refer to Table.6-2)

For example: 46HP=22HP+12HP+12HP

Power current: MCA=39.63+18.38+18.38=76.39; TOCA=44.9+23+23=90.9; MFA=50+25+25=100

Compressor: RLA=15.62+15.62+15.62+15.62=62.48

OFM: FLA=4.0+3.4+4.5+4.5=16.4

Notes:

1. RLA is based on the following conditions, Indoor temp. 27°C(80.6°F) DB/19°C(66.2°F) WB, Outdoor temp. 35°C(95°F) DB

2. TOCA means the total value of each OC set.

3. MSC means the Max. current during the starting of compressor.

4. Voltage range.

Units are suitable for use on electrical systems where voltage supplied to unit terminals is not below or above listed range limits.

5. Maximum allowable voltage variation between phases is 2%

6. Selection wire size based on the larger value of MCA or TOCA

7. MFA is used to select the circuit breaker and the ground fault circuit interrupter (earth circuit breaker).

**MCA:** Min. Circuit Amps. (A)

**TOCA:** Total Over-current Amps. (A)

**MFA:** Max. Fuse Amps. (A)

**MSC:** Max. Starting Amps. (A)

**RLA:** Rated Load Amps. (A)

**OFM:** Outdoor Fan Motor.

**FLA:** Full Load Amps. (A)

**KW:** Rated Motor Output (KW)

### 13.3 Electric wiring installation

**Note:**

- Please select power supply for indoor unit and outdoor unit separately.
- The power supply should have specified branch circuit with leakage protector and manual switch.
- The power supply, leakage protector and manual of all the indoor units connecting to the same outdoor unit should be universal. (Please set all the indoor unit power supply of one system into the same circuit. It should turn on or shut down the unit at the same time, otherwise, the service life would affect seriously, even the unit may not turn on.)
- Please put the connective wiring system between indoor unit and outdoor unit with refrigerant piping system together.
- It is suggested to use 3-core shielded wire as signal wire between indoor and outdoor units, multi-core wire is unavailable.
- Please comply with relevant National Electric Standard.
- Power wiring should be done by professional electrician.

#### 13.3.1 Outdoor unit powering supply wiring

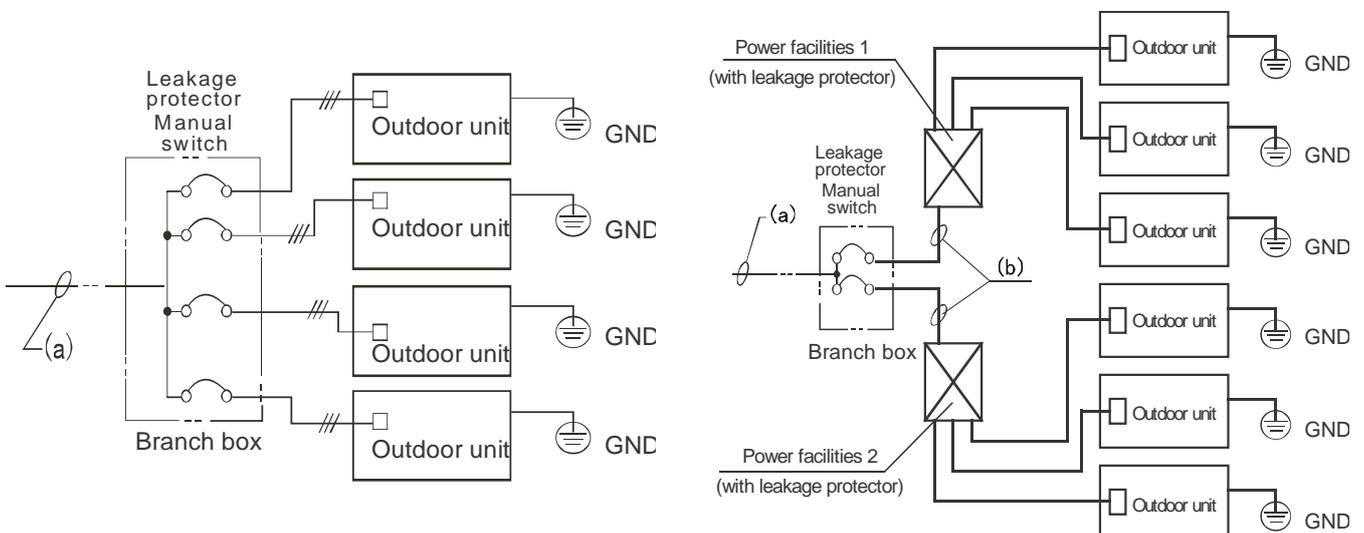
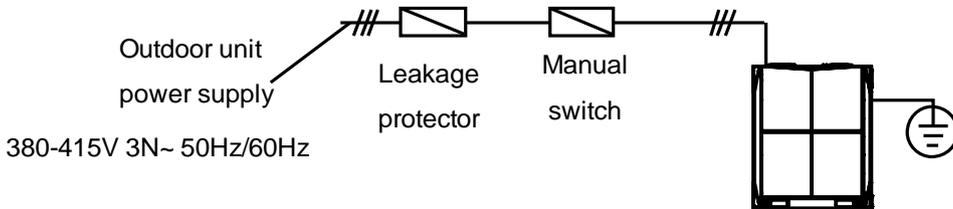

**13.3.2 Indoor unit powering supply wiring**

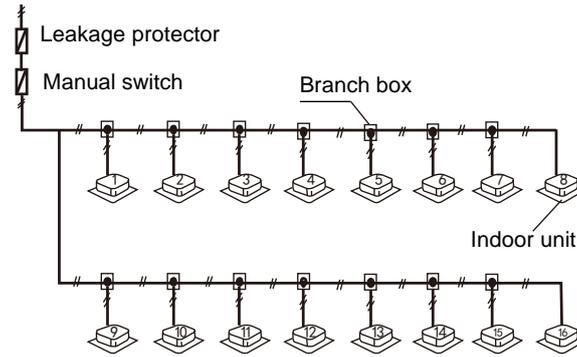

Note:

- Set refrigerant piping system, signal wires between indoor units and signal wires between outdoor units into one system.
- Power must unified supply to all indoor units in the one system.
- Please do not put the signal wires and power wires in the same wire tube; keep distance between the two tubes. (Keep distance above 11-13/16inch(300mm), when current capacity of power supply less than 10A, and keep distance above 19-11/16inch(500mm), when current capacity of power supply less than 50A).
- Make sure to address the outdoor unit which is in combination type.

**13.4 Control system installation**

The control line should be shielded wire. Using other wiring shall create signal interference, thus leading to error operation. The shielded nets at the two sides of shielded wires are either grounded to the earth, or connected with each other and jointed to the sheet metal along to the earth.

Control wire could not be bound together with refrigerant pipeline and power wire. When power wire and control wire is distributed in parallel form, keep gap between them above 11-13/16inch(300mm) so as to preventing signal interference.

Control wire could not form closed loop.

Control wire has polarity, so be careful when connecting.

The shield net should be grounded at the wiring terminal of outdoor unit. The inlet and outlet wire net of indoor communication wire should be connected directly and could not be grounded, and form open circuit at the shield net of final indoor unit.

**13.4.1 Signal wire between outdoor unit and indoor unit**

Signal wire of indoor/outdoor unit adopts 3-core shielded wire ( $\geq 0.0012\text{in.}^2(0.75\text{mm}^2)$ ) which has polarity, please connect it correctly.

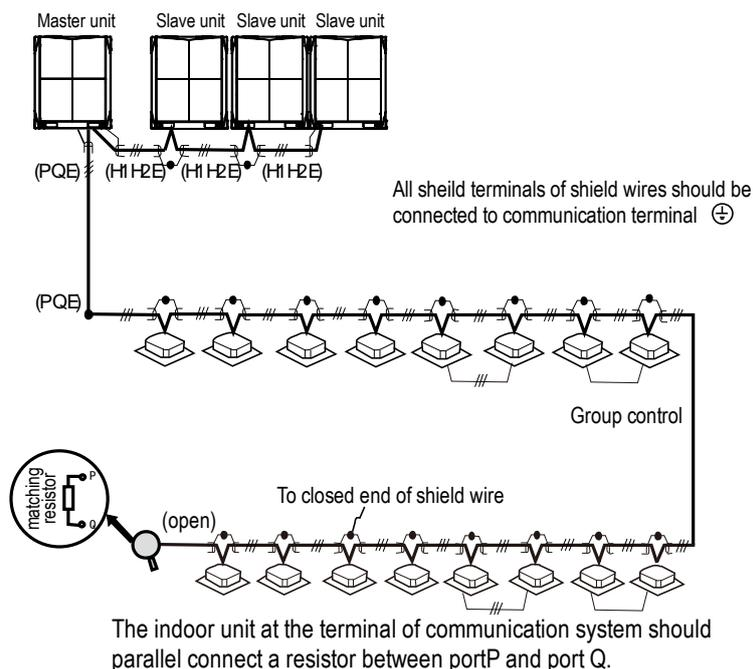

### 13.4.2 Example connection of wiring

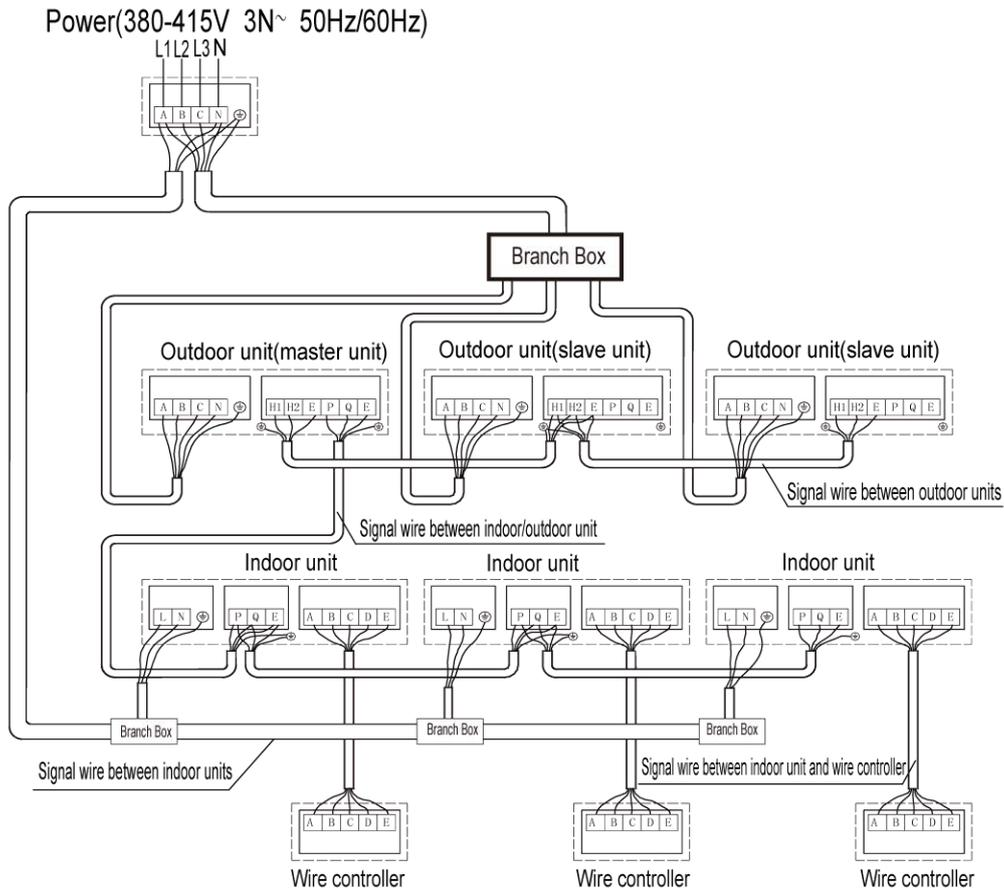

### 13.4.3 Signal wire of centralized control

When centralized control is needed, one CCM03 (central controller of indoor unit) can only control the indoor units which are in the same refrigerant system **via the port X Y E of outdoor unit**. Outdoor unit will automatically distribute the address to indoor units without any manual setting. Remote controller can enquiry and modify every indoor unit address.

The diagram below shows the connection of signal wire in this case:

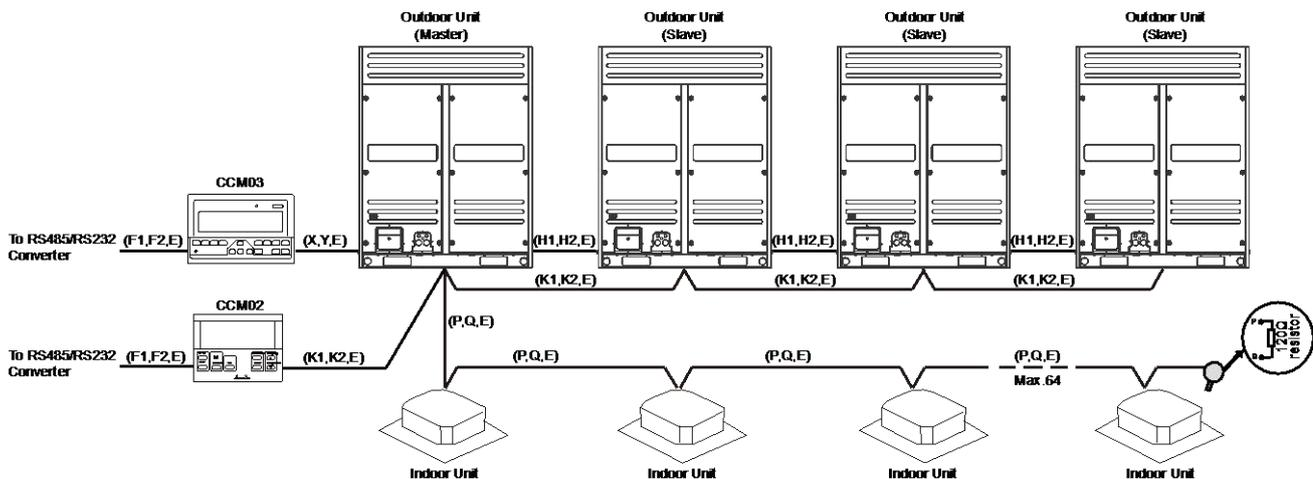

Besides, CCM03 can also connect indoor units **via the port X Y E of indoor unit**. However, one more group of wire (X Y E between indoor units) is needed; it is more complex and not suggested. Anyway, the diagram below shows the connection of signal wire in this case:

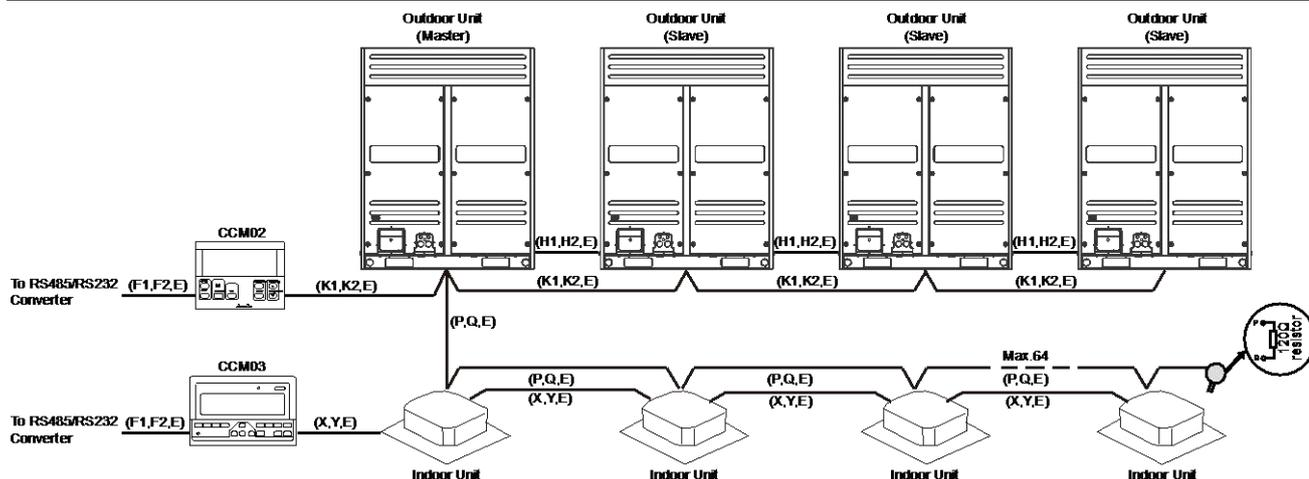

## 14. Running test

### 14.1 Inspection and confirmation before commissioning

- Check and confirm that refrigeration pipe line and communication wire of indoor and outdoor units have been connected to the same refrigeration system. Otherwise, operation troubles shall happen.
- Power voltage is within  $\pm 10\%$  rated voltage.
- Check and confirm that the power wire and control wire are correctly connected.
- Check whether wire controller is properly connected.
- Before powering on, confirm there is no short circuit to each line.
- Check whether all units have passed nitrogen pressure-keeping test for 24 hours with R410A:  $40\text{kg}/\text{cm}^2$  (580PSI).
- Confirm whether the system to debugging has been carried out vacuum drying and packed with refrigeration as required.

### 14.2 Preparation before debugging

- Calculate the additional refrigerant quantity for each set of unit according to the actual length of liquid pipe.
- Keep required refrigerant ready.
- Keep system scheme, system piping diagram and control wiring diagram ready.
- Record the setting address code on the system scheme.
- Turn on power switches of outdoor unit in advance, and keep connected for above 12 hours so that heater heating up refrigerant oil in compressor.
- Turn on all valves. If the above valves do not be turned on totally, the unit should be damaged.
- Check whether the power phase sequence of outdoor unit is correct.
- All dial switch of indoor and outdoor units have been set according to the Technical Requirement of Product.

**Note:** The setting of outdoor unit’s dial switch should be conducted under power-off, otherwise the unit shall not identify. The following table shows the address and power of outdoor master and slave unit:

ADDRESS dial switch		POWER dial switch	
0	Master unit	0	8HP
1	Salve unit 1	1	10HP
2	Salve unit 2	2	12HP
3	Salve unit 3	3	14HP
$\geq 4$	Invalid address, system error	4	16HP
/		5	18HP
/		6	20HP
/		7	22HP
/		$\geq 8$	Invalid dial switch

### 14.3 Commissioning of Trial Run

#### 14.3.1 Commissioning for trial run of single unit.

1. Each independent refrigeration system (i.e. each outdoor unit) should be conducted trial operation.
2. Detection details of trial run:
  - 1) As for fan in unit, make sure the rotating route of its impeller is correct and impeller turns around smoothly. No abnormal vibration and noise.
  - 2) Check whether there is abnormal noise during operation of refrigerant system and compressor.
  - 3) Check outdoor unit whether it can detect each indoor unit.
  - 4) Check whether drainage is smooth and its lift pump can be in motion.
  - 5) Check whether microcomputer controller can be in motion normally and whether any trouble appears.
  - 6) Check whether operating current is within the allowed range.
  - 7) Check whether each operating parameter is within the range permitted by the equipment.

**Note:** When conducting trial run, separately test cooling mode and heating mode to judge the stability and reliability of system.

#### 14.3.2 Commissioning for the trial run of the paralleled system

1. Check and confirm that operation of single unit is normal through trial operation. After confirm it is normal, conduct operation of the whole system, i.e., Commissioning of MDV system.
2. Commissioning is carried out according to the Technical Requirement of Product. When Commissioning, analyze and record operation status so as to understand the operation status of the whole system for convenient maintenance and examination.
3. After finishing Commissioning, fill out Commissioning report in detail.

#### 14.4 Fill the name of connected system

To clearly identify the connected systems among two or more indoor units and outdoor units, select names for every system and record them on the nameplate on the outdoor electric control box cover.

Model(indoor unit)	
Room Name Eg: Indoor unit (A) of the first system on second floor is recorded as:-2F-1A	

#### 14.5 Caution on refrigerant leakage

- This air conditioner adopts R410A as refrigerant, which is safe and noncombustible.
- The room for air conditioner should be big enough that refrigerant leakage cannot reach the critical thickness. Besides this, you can take some action on time.
- R410A critical thickness:  $0.3 \text{ kg/m}^3$  ( $0.02 \text{ lbs./ft}^3$ ), (Critical thickness: the max thickness of Freon without any harm to person)

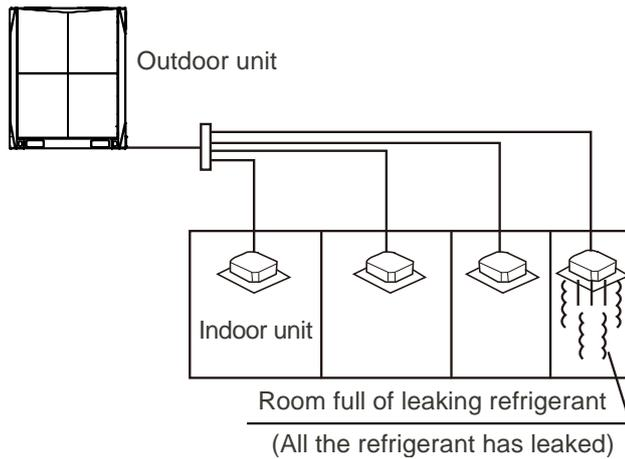

- Calculate the critical thickness through following steps, and take necessary actions.
  1. Calculate the refrigerant charge A
  2. Total refrigerant charge = delivered refrigerant charge (nameplate) + supplemental refrigerant charge
  3. Calculate the indoor volume (B) (as the minimum volume)
  4. Calculate the refrigerant thickness.
 
$$A/B \leq \text{critical thickness } 0.3\text{kg/m}^3 \text{ (0.02lbs./ft}^3\text{)}$$
- Countermeasure to over-high refrigerant thickness
  1. Install mechanical ventilator to reduce the refrigerant thickness under critical level. (Ventilate regularly)
  2. Install leakage detector alarming device related to mechanical ventilator if you cannot regularly ventilate.

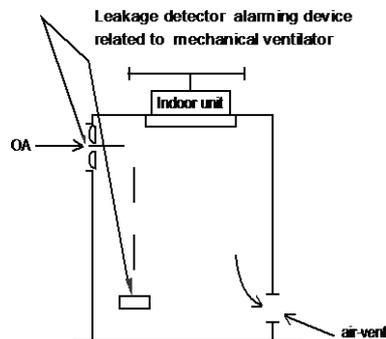



The commissioning report form is shown as follows:

## Commissioning Report for Maxi MVD

Date: \_\_\_\_\_dd\_\_\_\_mm\_\_\_\_yy

<b>Item name:</b>	
<b>Address:</b>	<b>Tel:</b>
<b>Supplier:</b>	<b>Delivery date: dd mm yy</b>
<b>Installation section:</b>	<b>Principal:</b>
<b>Commissioning section:</b>	<b>Principal:</b>
<b>Remark: recharged refrigeration quantity to system: _____kg</b>	

Installing section: \_\_\_\_\_

(seal)

Signature: \_\_\_\_\_

Date: \_\_\_\_\_dd\_\_\_\_mm\_\_\_\_yy

Commissioning name: \_\_\_\_\_

(seal)

Signature: \_\_\_\_\_

Date: \_\_\_\_\_dd\_\_\_\_mm\_\_\_\_yy

## Test Data for Test Run of \_\_\_\_\_ System

<b>Model of outdoor unit</b>	<b>Production series no.</b>

### Operation data of outdoor unit (Cooling)

Unit	No.1	No.2	No.3
Run Voltage V			
Total current of run A			
Operation current of compressor A			
High-pressure pressure Kg/cm <sup>2</sup>			
Low-pressure pressure Kg/cm <sup>2</sup>			
Inlet air temperature °C			
Outlet air temperature °C			

### Operation data of indoor unit

No.	Position	Model	Bar code of indoor unit	Inlet air temperature °C	Outlet air temperature °C
1					
2					
3					
4					
5					
6					
7					
8					
9					
10					
11					
12					
13					
14					
15					
16					

**System check (SW2)**

**SW2:** (CHECK)—Used to query outdoor unit data. Check point sequence and corresponding actuality is as follows:

No.	Normal display	Content (present frequency)	Note
1	0 - -	Outdoor unit address	Master unit: 0; slave unit: 1, 2, 3.
2	1 - -	Outdoor unit capacity	Refer to note 1
3	2 - -	Outdoor unit quantity	Available for master unit
4	3 - -	Setting quantity of indoor unit	Available for master unit
5	4 - -	Total capacity of outdoor units	Available for master unit
6	5 - -	Total capacity requirement of indoor units	Capacity requirements
7	6 - -	Total correct capacity requirement of master unit	Capacity requirements
8	7 - -	Running mode	Refer to note 2
9	8 - -	Actual running capacity of this outdoor unit	Capacity requirement
10	9 - -	Fan A speed	Refer to note 3
11	10 - -	Fan B speed	Refer to note 3
12	11 - -	Temperature of evaporator pipe (T2B/T2)	Actual value=display value
13	12 - -	Temperature of condenser pipe (T3)	Actual value=display value
14	13 - -	Temperature of outdoor ambient (T4)	Actual value=display value
15	14 - -	Discharge temperature of inverter compressor A	Actual value=display value
16	15 - -	Discharge temperature of inverter compressor B	Actual value=display value
17	16 - -	Main inverter module temperature	Actual value=display value
18	17 - -	Saturation temperature corresponding to the discharge pressure	Actual value=display value+30
19	18 - -	Current of inverter compressor A	Actual value=display value
20	19 - -	Current of inverter compressor B	Actual value=display value
21	20 - -	Opening degree of EXVA	Pulse value=display value×8
22	21 - -	Opening degree of EXVB	Pulse value=display value×8
23	22 - -	High pressure	Actual value=display value×0.1MPa
24	23 - -	Low pressure (Reserved)	/
25	24 - -	Quantity of indoor units which are communicated with master unit	Actual value=display value
26	25 - -	Quantity working indoor unit	Actual value=display value
27	26 - -	Priority mode	Refer to note 4
28	27 - -	Silent mode	Refer to note 5
29	28 - -	Static pressure mode	Refer to note 6
30	29 - -	DC voltage A	Actual value=display value×10
31	30 - -	DC voltage B	Actual value=display value×10
32	31 - -	Reserved	/
33	32 - -	The last error or protection code	Display 000 if it has no error or protection
34	33 - -	Error clearance time	Actual value=display value
35	34 - -	----	End

**Note:**

- Outdoor unit capacity setting: 0—8HP; 1—10HP; 2—12HP; 3—14HP; 4—16HP; 5—18HP; 6—20HP; 7—22HP.
- Running mode: 0—OFF; 2—cooling mode; 3—heating mode; 4—forced cooling mode.
- Fan speed: 0—stop; 1~15—fan speed sequentially increase.
- Priority mode: 0—heating priority mode; 1—cooling priority mode; 2—VIP (address no. 63) priority mode or voting priority mode; 3—heating only priority mode; 4—cooling only priority mode.
- Silent mode: 0—night silent mode; 1—silent mode; 2—super silent mode; 3—no silent mode.
- Static pressure mode: 0—none static pressure; 1—low static pressure; 2—medium static pressure; 3—high static pressure.

**Normal display:** When the outdoor unit is in standby, the first two numbers on LED digital tube will display the address of the outdoor unit, and the last two numbers display the indoor unit's quantity which can communicate with outdoor unit. When the outdoor unit is operating, it will display the rotation frequency of the compressor.

**System check steps:**

- Let the system steady operation for more than 1 hours;
- Press the check button (SW2) on main PCB of outdoor master unit;
- Check the parameters one by one and fill out the commissioning tables.

---

# Part 5 Troubleshooting

1. Outdoor electric control box assembly instructions .....	171
2. Outdoor main control board instructions .....	173
3. Error code table.....	179
4. Troubleshooting .....	180

# 1. Outdoor electric control box assembly instructions

8/10/12HP

Bottom layer of electric control box

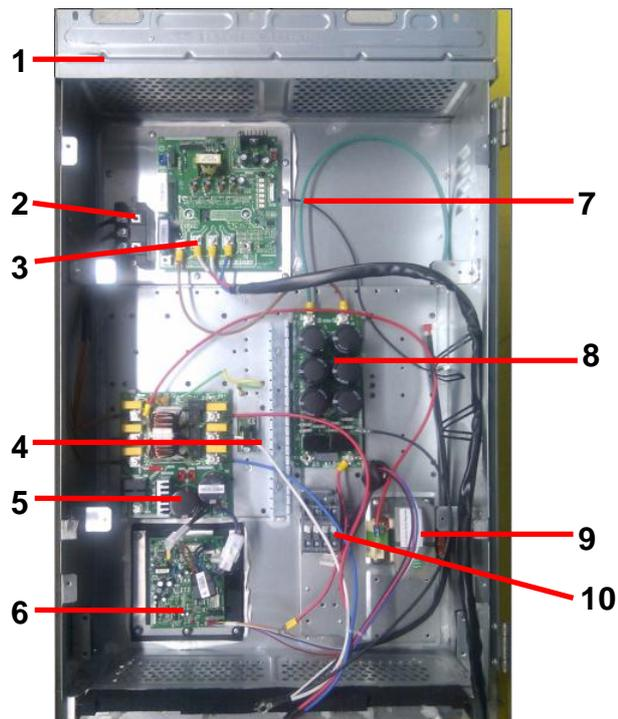

Top layer of electric control box

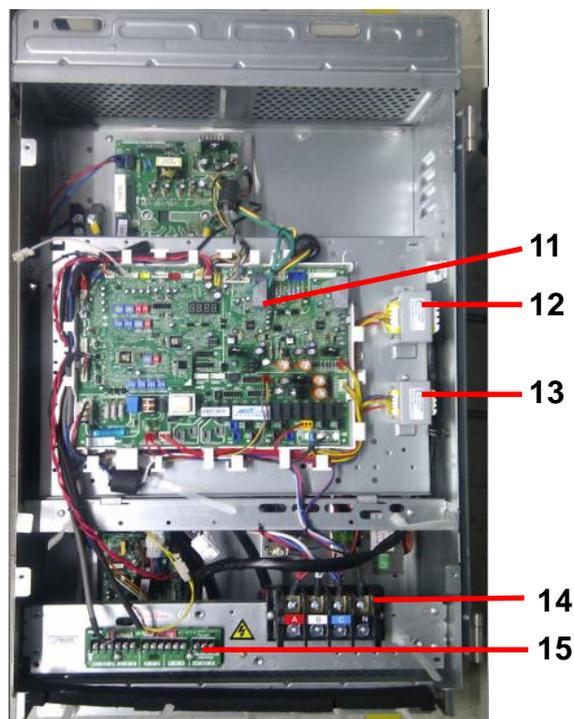

No.	Content
1	Electric control box assembly
2	Three phase bridge rectifier
3	Inverter module
4	Outdoor current detection board
5	Outdoor power supply board
6	DC fan module
7	Temperature sensor
8	Filter board
9	Reactor
10	Contactor
11	Main PCB
12	Power transformer
13	Power transformer
14	Terminal block, 4P
15	Intermediate adapter board

14/16/18/20/22HP

Bottom layer of electric control box



Top layer of electric control box

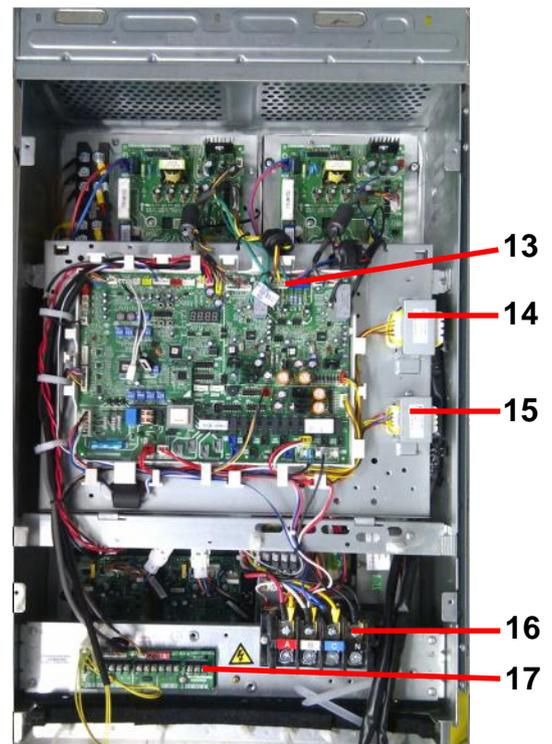

No.	Content
1	Electric control box assembly
2	Inverter module
3	Three phase bridge rectifier
4	Temperature sensor
5	Outdoor power supply board
6	Outdoor current detection board
7	Outdoor power supply board
8	DC fan module
9	Inverter module
10	Filter board
11	Reactor
12	Contactor
13	Main PCB
14	Power transformer
15	Power transformer
16	Terminal block, 4P
17	Intermediate adapter board

## 2. Outdoor main control board instructions

### 2.1 Main PCB ports instructions

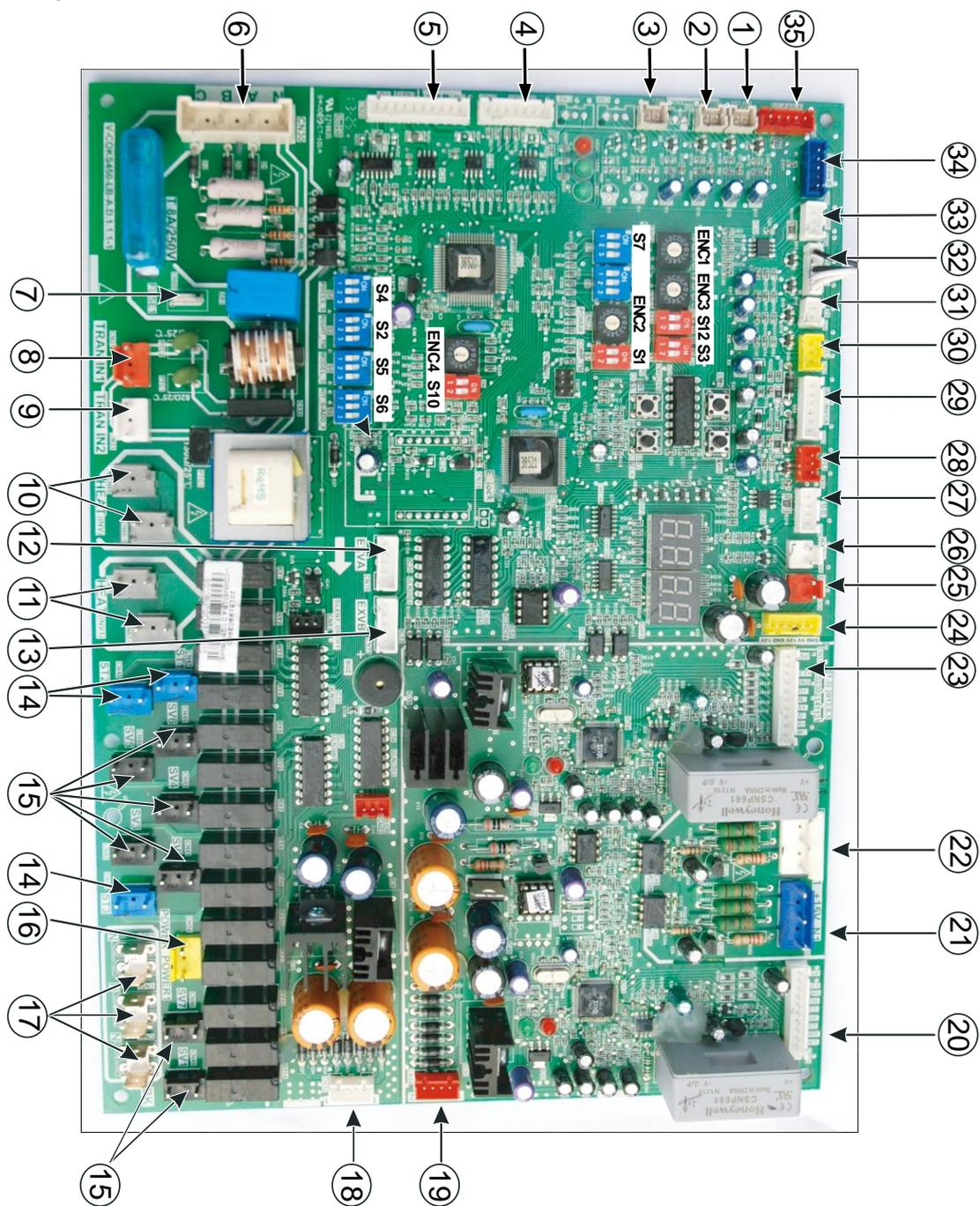

**Outdoor main PCB ports instructions**

No.	Port code	Content	Port voltage
1	CN10	Discharge temperature detection port of inverter compressor A	DC 0~5V (in dynamic change)
2	CN11	Discharge temperature detection port of inverter compressor A or B	DC 0~5V (in dynamic change)
3	CN4	Temperature detection port of inverter module	DC 0~5V (in dynamic change)
4	CN26	Reserved	/
5	CN25	Wiring port for communication between indoor and outdoor units, indoor unit network, outdoor unit network and network accounting	DC 2.5~2.7V
6	CN30	Three-phase detection port	380V
7	CN80	Reserved	/
8	CN31	Power input of No.1 transformer	220V
9	CN33	Power input of No.2 transformer	220V
10	CN66	Heat output of inverter compressor A electrical heater	220V
11	CN67	Heat output of inverter compressor B electrical heater	220V
12	CN70	Drive port of EXV A	The first pin on left: DC 12V
13	CN71	Drive port of EXV B	The other four pins: in dynamic change
14	CN47-CN49	Four-way valve output port	220V
15	CN41-CN45	One-way valve output port	220V
16	CN54	Power output port	220V
17	CN57-CN59	Null line terminal	0
18	CN32	Power output of No.1 transformer	The voltage between upper tow pins: AC 13.5V; The voltage between under tow pins: AC 9V
19	CN34	Power output of No.2 transformer	The voltage between upper tow pins: AC 14.5V; The voltage between under tow pins: AC 14.5V
20	CN39	Activation port of inverter module B	The third pin on the left: DC3.3V
21	CN38	Voltage detection port of inverter module B	DC 540V, +15V, N
22	CN36	Voltage detection port of inverter module A	DC 540V, +15V, N
23	CN37	Activation port of inverter module A	The third pin on the left: DC3.3V
24	CN35	Power supply port of main PCB	GND, +5V, +12V, GND, 12V
25	CN19	ON/OFF signal input port for system low pressure detection	0 or 5V
26	CN18	ON/OFF signal input port for system high pressure detection	0 or 5V
27	CN28	Reserved	/
28	CN16	Reserved	/
29	CN15	Current detection port of inverter compressor A and B	AC 0~7.8V (in dynamic change)
30	CN17	Input port for system high pressure detection	DC 0~5V (in dynamic change)
31	CN2	Reserved	/
32	CN1	Outdoor ambient temperature and condenser temperature detection port	DC 0~5V (in dynamic change)
33	CN20	Outdoor units communication port	DC 2.5~2.7V
34	CN65	Control port of DC fan B	The first pin on left: DC 12V
35	CN64	Control port of DC fan A	The other four pins: in dynamic change



### 2.2 Main PCB parts instructions

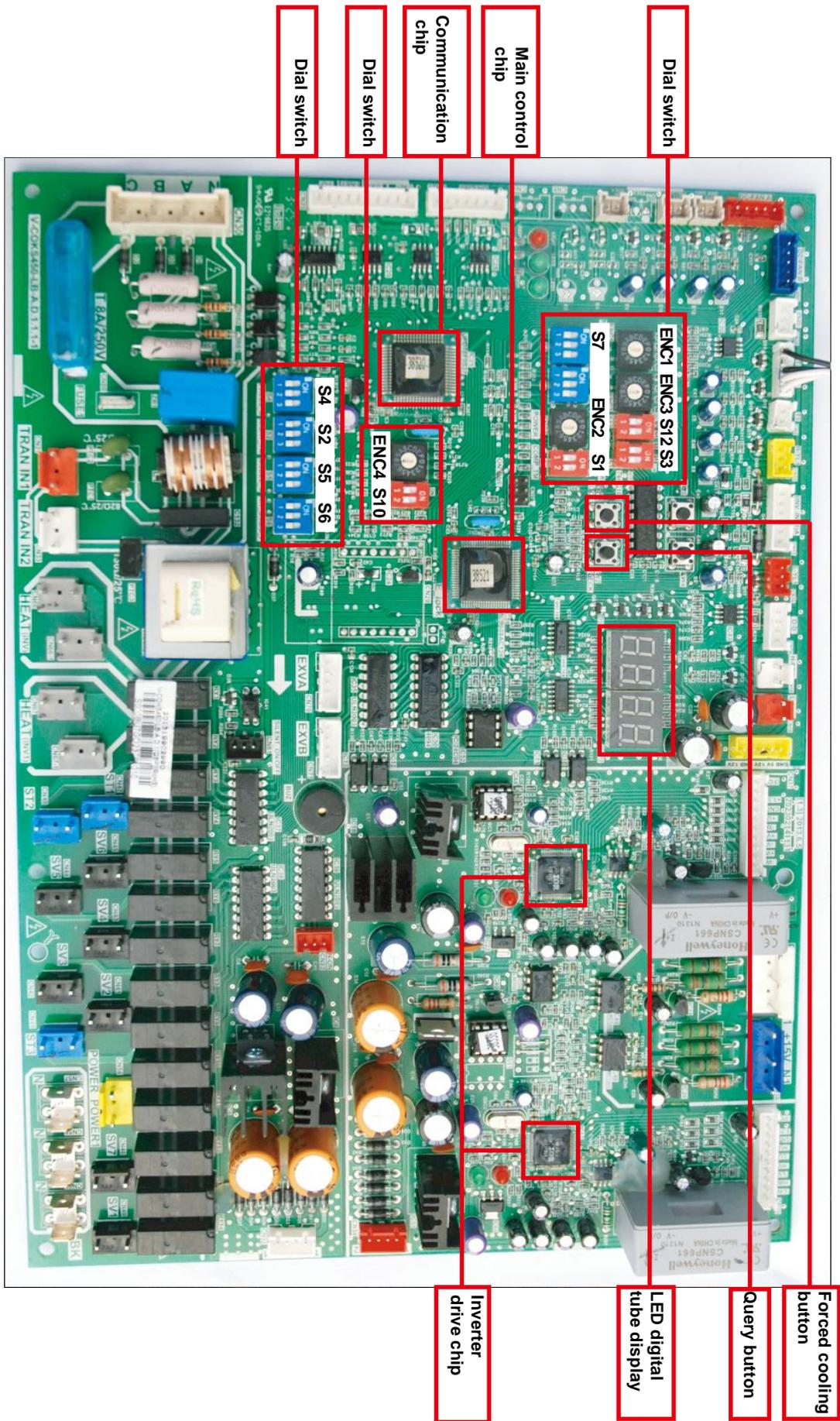

**2.2.1 Query content instructions**

No.	Normal display	Content (present frequency)	Note
1	0 - -	Outdoor unit address	Master unit: 0; slave unit: 1, 2, 3.
2	1 - -	Outdoor unit capacity	Refer to note 1
3	2 - -	Outdoor unit quantity	Available for master unit
4	3 - -	Setting quantity of indoor unit	Available for master unit
5	4 - -	Total capacity of outdoor units	Available for master unit
6	5 - -	Total capacity requirement of indoor units	Capacity requirements
7	6 - -	Total correct capacity requirement of master unit	Capacity requirements
8	7 - -	Running mode	Refer to note 2
9	8 - -	Actual running capacity of this outdoor unit	Capacity requirement
10	9 - -	Fan A speed	Refer to note 3
11	10 - -	Fan B speed	Refer to note 3
12	11 - -	T2B/T2 average temperature	Actual value=display value
13	12 - -	T3 pipe temperature	Actual value=display value
14	13 - -	T4 ambient temperature	Actual value=display value
15	14 - -	Discharge temperature of inverter compressor A	Actual value=display value
16	15 - -	Discharge temperature of inverter compressor B	Actual value=display value
17	16 - -	Main inverter module temperature	Actual value=display value
18	17 - -	Saturation temperature corresponding to the discharge pressure	Actual value=display value+30
19	18 - -	Current of inverter compressor A	Actual value=display value
20	19 - -	Current of inverter compressor B	Actual value=display value
21	20 - -	Opening degree of EXVA	Pulse value=display value×8
22	21 - -	Opening degree of EXVB	Pulse value=display value×8
23	22 - -	High pressure	Actual value=display value×0.1MPa
24	23 - -	Low pressure (Reserved)	/
25	24 - -	Quantity of indoor units which are communicated with master unit	Actual value=display value
26	25 - -	Quantity working indoor unit	Actual value=display value
27	26 - -	Priority mode	Refer to note 4
28	27 - -	Silent mode	Refer to note 5
29	28 - -	Static pressure mode	Refer to note 6
30	29 - -	DC voltage A	Actual value=display value×10
31	30 - -	DC voltage B	Actual value=display value×10
32	31 - -	Reserved	/
33	32 - -	The last error or protection code	Display 000 if it has no error or protection
34	33 - -	Error clearance time	Actual value=display value
35	34 - -	----	End

Note:

When the outdoor unit is in standby, the first two numbers on LED digital tube will display the address of the outdoor unit, and the last two numbers display the indoor unit's quantity which can communicate with outdoor unit. When the outdoor unit is operating, it will display the rotation frequency of the compressor.

1. Outdoor unit capacity setting: 0—8HP; 1—10HP; 2—12HP; 3—14HP; 4—16HP; 5—18HP; 6—20HP; 7—22HP.
2. Running mode: 0—OFF; 2—cooling mode; 3—heating mode; 4—forced cooling mode.
3. Fan speed: 0—stop; 1~15—fan speed sequentially increase.
4. Priority mode: 0—heating priority mode; 1—cooling priority mode; 2—VIP (address no. 63) priority mode or voting priority mode; 3—heating only priority mode; 4—cooling only priority mode.
5. Silent mode: 0—night silent mode; 1—silent mode; 2—super silent mode; 3—no silent mode.
6. Static pressure mode: 0—none static pressure; 1—low static pressure; 2—medium static pressure; 3—high static pressure.

**2.2.2 Dial switch setting**

**S1: Starting time setting**

	Starting time is 10 minutes
	Starting time is 12 minutes (default)

**S2: Night silent time setting**

	Night silent time is 6h/10h (default)
	Night silent time is 6h/12h
	Night silent time is 8h/10h
	Night silent time is 8h/12h

**S3: Silent mode selection**

	Night silent mode (default)
	Silent mode
	Super silent mode.
	None silent mode.

**S4: Static pressure mode selection**

	None static pressure(default) (0-20Pa)
	Low static pressure mode (reserved, can be customized)
	Medium static pressure mode (reserved, can be customized)
	High static pressure mode (20-40Pa)

**ENC3+S12: Indoor unit quantity setting**

		The quantity of indoor unit is 0-15 0~9 on ENC3 refer to 0~9 indoor units; A~F on ENC3 refer to 10~15 indoor units.
		The quantity of indoor unit is 16-31 0~9 on ENC3 refer to 16~25 indoor units; A~F on ENC3 refer to 26~31 indoor units.
		The quantity of indoor unit is 32-47 0~9 on ENC3 refer to 32~41 indoor units; A~F on ENC3 refer to 42~47 indoor units.
		The quantity of indoor unit is 48-63 0~9 on ENC3 refer to 48~57 indoor units; A~F on ENC3 refer to 58~63 indoor units.

**S5: Priority mode selection**

	Heating priority mode (default)
	Cooling priority mode
	VIP (address no. 63) priority mode or voting priority mode
	Heating only priority mode
	Cooling only priority mode

**S6: Auto addressing mode selection**

	Auto addressing
	None auto addressing (default)
	Clean the indoor unit address

**S7: Set the indoor units' numbers selection**

	No need to set the numbers of indoor units (default)
	Need to set the numbers of indoor units

**S8: Reserved**

--	--

**S10: Reserved**

--	--

**ENC1: Outdoor unit address setting**

ENC1 	Only 0, 1, 2, 3 are available. 0 is for master unit; 1, 2, 3 are for slave units
---	---

**ENC2: Outdoor unit capacity setting**

ENC2 	Only 0, 1, 2, 3, 4, 5, 6, 7 are available. 0: 8HP; 1: 10HP; 2: 12HP; 3: 14HP; 4: 16HP; 5: 18HP; 6: 20HP; 7: 22HP.
---	--

**ENC4: Network address setting**

ENC4 	Only 0, 1, 2, 3, 4, 5, 6, 7 are available.
---	--

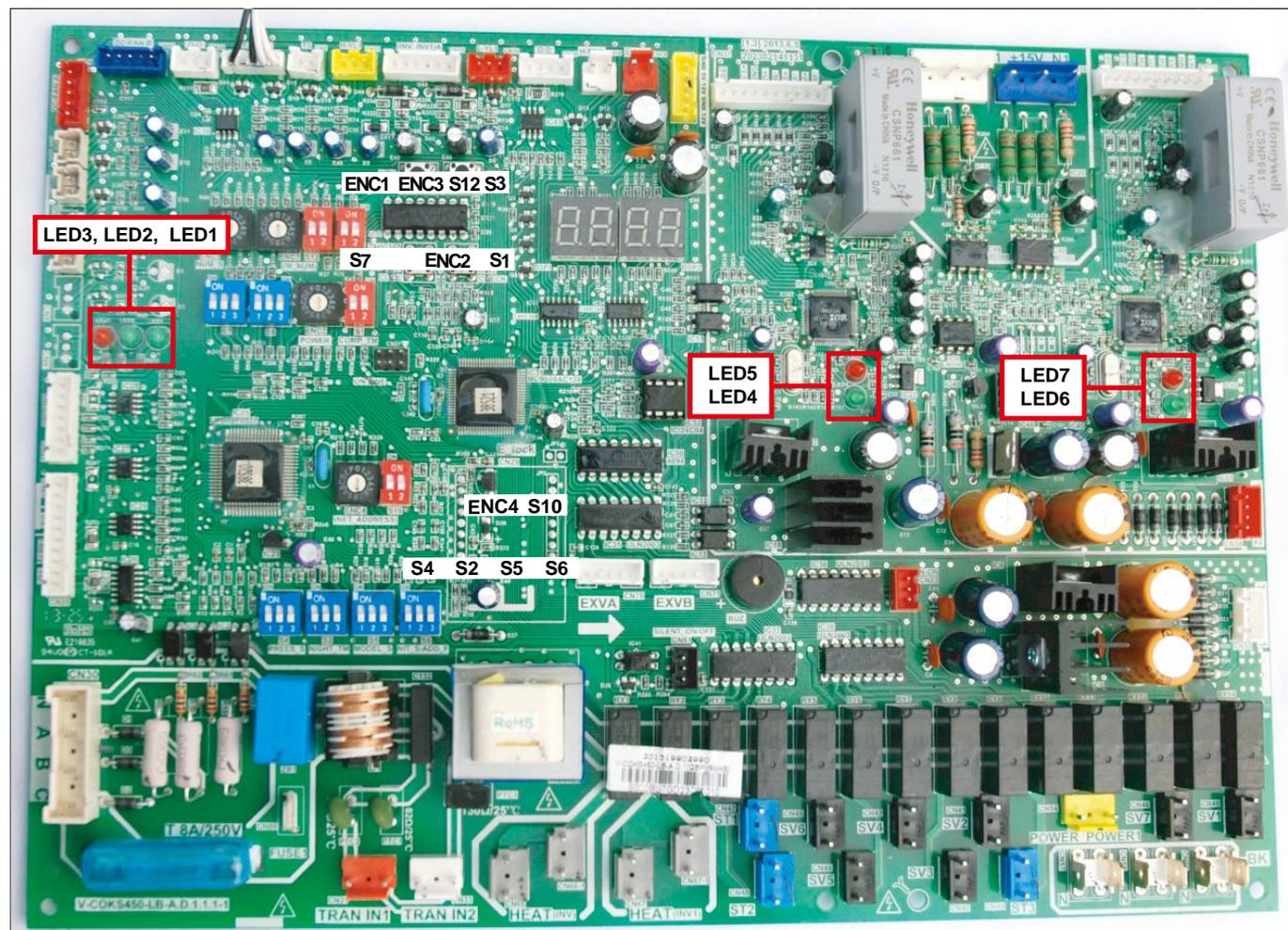
**2.3 LED on main control board instructions**

**LED1:** Power supply indicator lamp. The lamp will be on if the power supply is normal.

**LED2:** Running indicator lamp. The lamp will be on if the system running is normal.

**LED3:** Malfunction indicator lamp of network centralized control chip. The lamp will flash if three-phase sequence protection or communication errors (communication between indoor units and outdoor units, communication among indoor units, communication among chips).

**LED4:** Running indicator lamp of inverter module. The lamp will be on if the compressor is running.

**LED5:** Malfunction indicator lamp of inverter module. LED5 will be on and the LED4 will flash if the inverter module is faulty and the error code will display on digital tube by press query button.

**LED6:** Running indicator lamp of inverter module. The lamp will be on if the compressor is running.

**LED7:** Malfunction indicator lamp of inverter module. LED7 will be on and the LED6 will flash if the inverter module is faulty and the error code will display on digital tube by press query button.

### 3. Error code table

Error code	Content	Note
E0	Communication error between outdoor units	Only display on the faulty slave unit
E1	Phase sequence error	Display on the faulty unit
E2	Communication error between indoor units and the master unit.	Only display on the master unit
E3	Reserved	/
E4	Malfunction of outdoor ambient temperature sensor (T4)	Display on the faulty unit
E5	Malfunction of power supply voltage	Display on the faulty unit
E6	Reserved	/
E7	Malfunction of discharge temperature sensor	Display on the faulty unit
E8	Faulty outdoor unit address	Display on the faulty unit
xE9	Driver model is mismatched	When x is 1, it means A system; 2 means B system
xH0	Malfunction of communication between main control chip and inverter driver chip	Display on the faulty unit
H1	Malfunction of communication between main control chip and communication chip	Display on the faulty unit
H2	Faulty outdoor unit quantity (decreased)	Only display on the master unit
H3	Faulty outdoor unit quantity (increased)	Only display on the master unit
xH4	P6 protection appears three times in 60 minutes	Display on the faulty unit Cannot be recovered until re-power on
H5	P2 protection appears three times in 60 minutes	Display on the faulty unit Cannot be recovered until re-power on
H6	P4 protection appears three times in 100 minutes	Display on the faulty unit Cannot be recovered until re-power on
H7	Faulty indoor units quantity	Display on the master unit Cannot be recovered until unit quantity recover
H8	Malfunction of pressure sensor for discharge pipe	The discharge pressure $P_c \leq 0.3\text{MPa}(43.5\text{PSI})$
H9	P9 protection appears three times in 60 minutes	Display on the faulty unit Cannot be recovered until re-power on
Hc	Reserved	/
F0	PP protection appears three times in 150 minutes	Display on the faulty unit Cannot be recovered until re-power on
C7	PL protection appears three times in 100 minutes	Display on the faulty unit Cannot be recovered until re-power on
yHd	Slave units malfunction	Y stands for corresponding slave unit, y=1, 2, 3.
P0	Temperature protection of inverter compressor	Display on the faulty unit
P1	High pressure protection	Display on the faulty unit
P2	Low pressure protection	Display on the faulty unit
xP3	Over current protection of compressor	Display on the faulty unit
P4	Discharge temperature protection	Display on the faulty unit
P5	Condenser high temperature protection	Display on the faulty unit
xP6	Inverter module protection	When X is 1, it means A inverter module; 2 means B inverter module
P9	Fan module protection	Display on the faulty unit
PL	Temperature protection of inverter module	Display on the faulty unit
PP	Insufficient overheat degree protection of compressor discharge	Display on the faulty unit
xL0	Inverter module error	Display after P6 displaying for one minute
xL1	DC generatrix low voltage error	Display after P6 displaying for one minute
xL2	DC generatrix high voltage error	Display after P6 displaying for one minute
xL3	Reserved	/
xL4	MCE error/ synchronization/ closed loop	Display after P6 displaying for one minute
xL5	Zero speed protection	Display after P6 displaying for one minute
xL6	Reserved	/
xL7	Phase sequence error	Display after P6 displaying for one minute
xL8	Frequency difference in one second more than 15Hz protection	Display after P6 displaying for one minute
xL9	Frequency difference between the real and the setting frequency more than 15Hz protection	Display after P6 displaying for one minute

## 4. Troubleshooting

### 4.1 E0: Communication error between outdoor units

The error only display on faulty slave unit, all the ODU's will be standby.

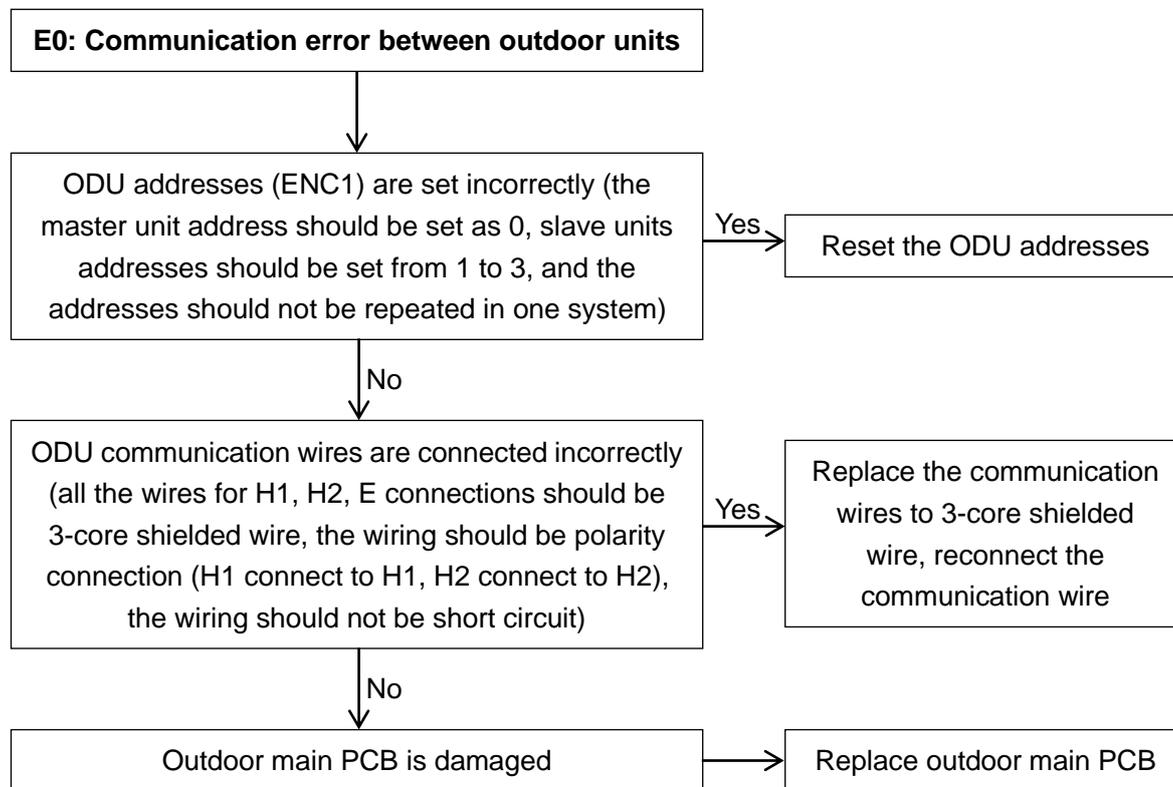

2-core shielded wire (x)



3-core shielded wire (✓)

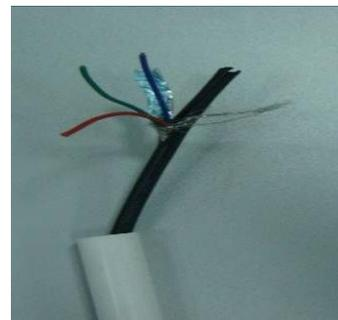

**4.2 E1: Phase sequence error**

The error only display on faulty unit, all the ODU will be standby.

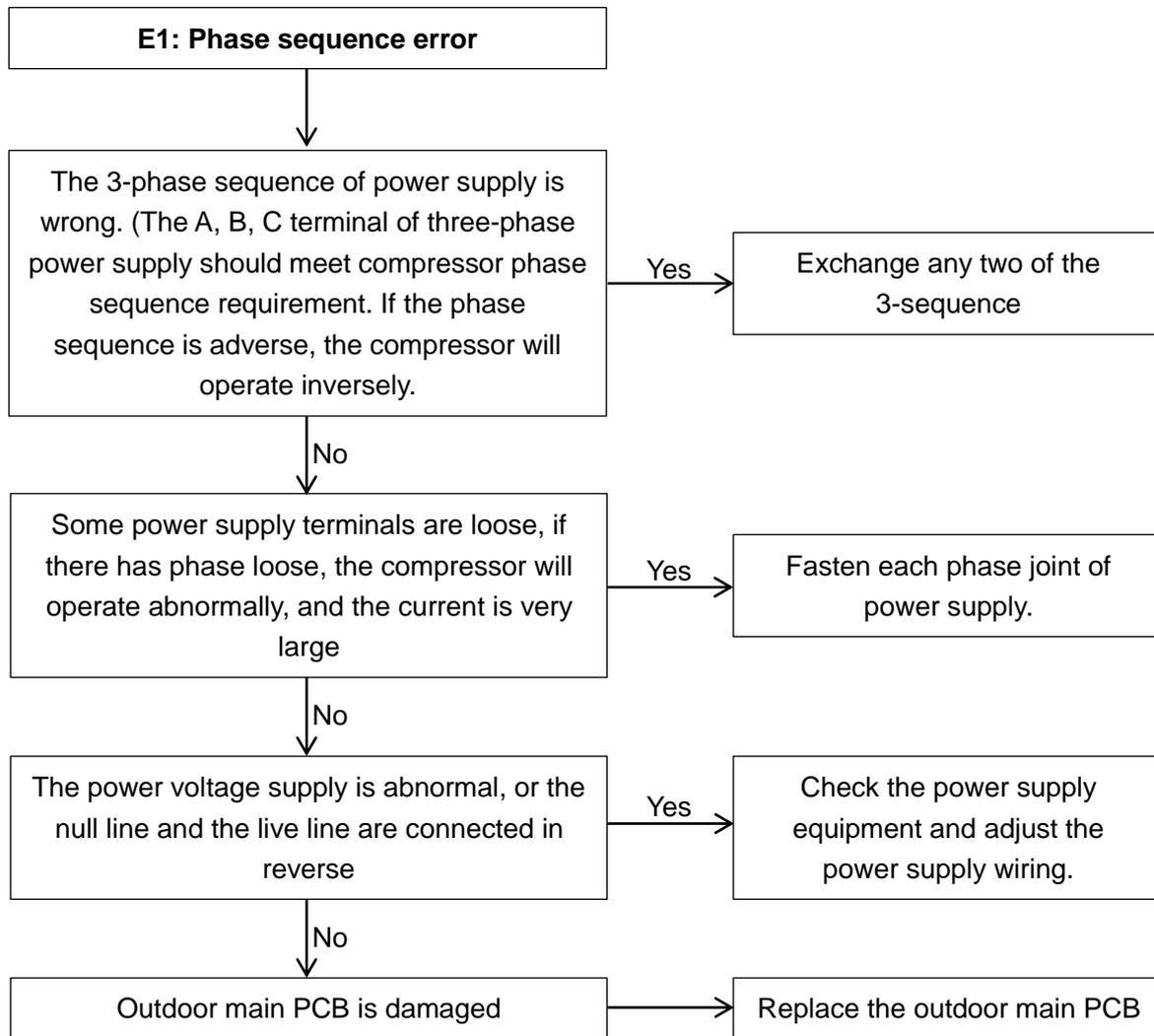

**Note:**

If the wiring connection of each outdoor unit is according to A, B, C phase sequence, when the quantity of outdoor units is large, the current difference between C phase and A, B phase will be very large for the power supply load of each outdoor unit is on C phase, it is very easy to lead to air switch break and wiring terminal burnout. So when the quantity of outdoor units is large, the phase sequence should be staggered, then the current can be distributed to the three phases equally.

### 4.3 E2: Communication error between indoor units and the master unit

The error only display on faulty slave unit, all the ODU will be standby.

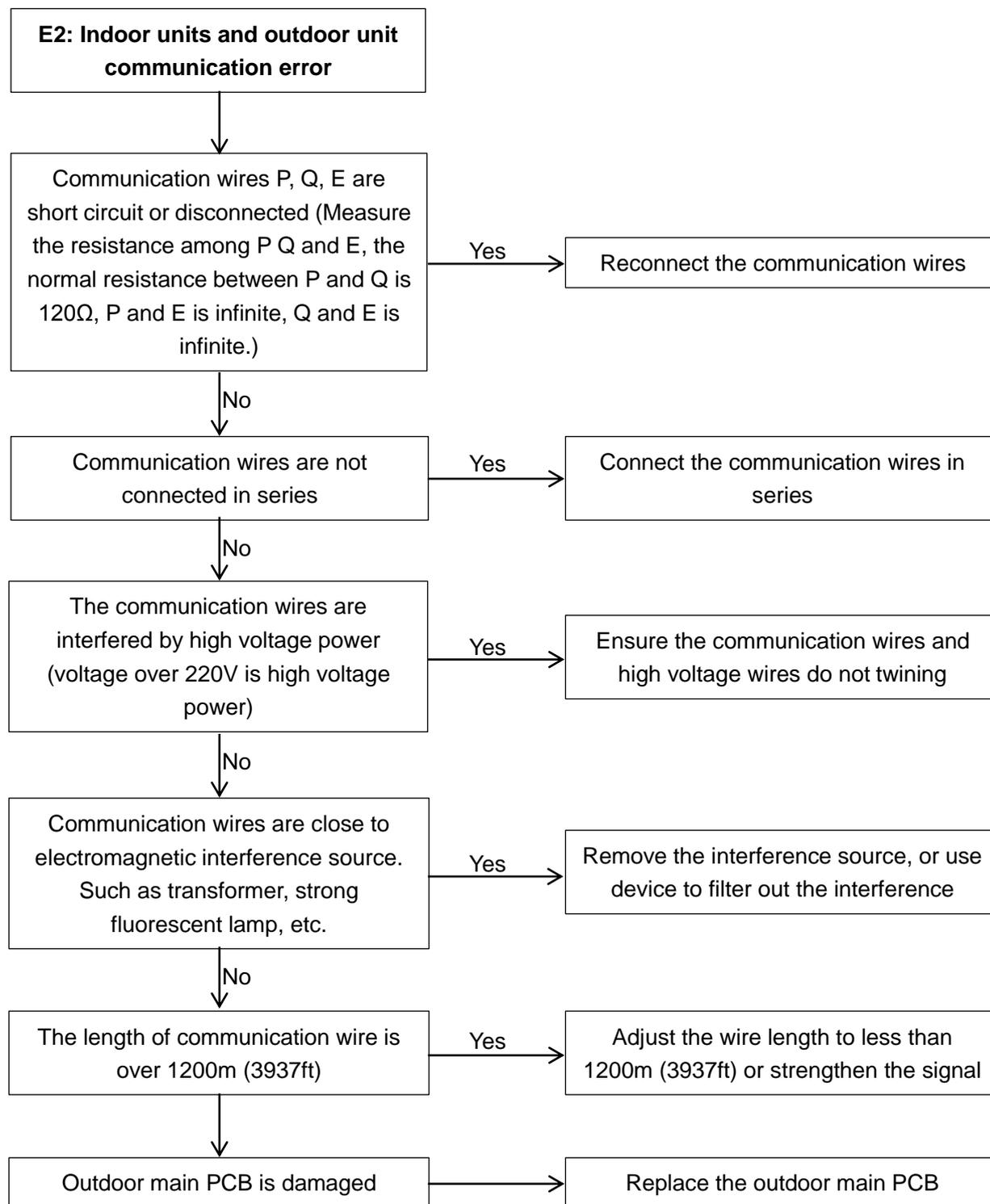



**4.4 E4: Malfunction of outdoor ambient temperature sensor (T4)****4.5 E7: Malfunction of discharge temperature sensor**

The error only display on faulty unit, all the ODU will be standby.

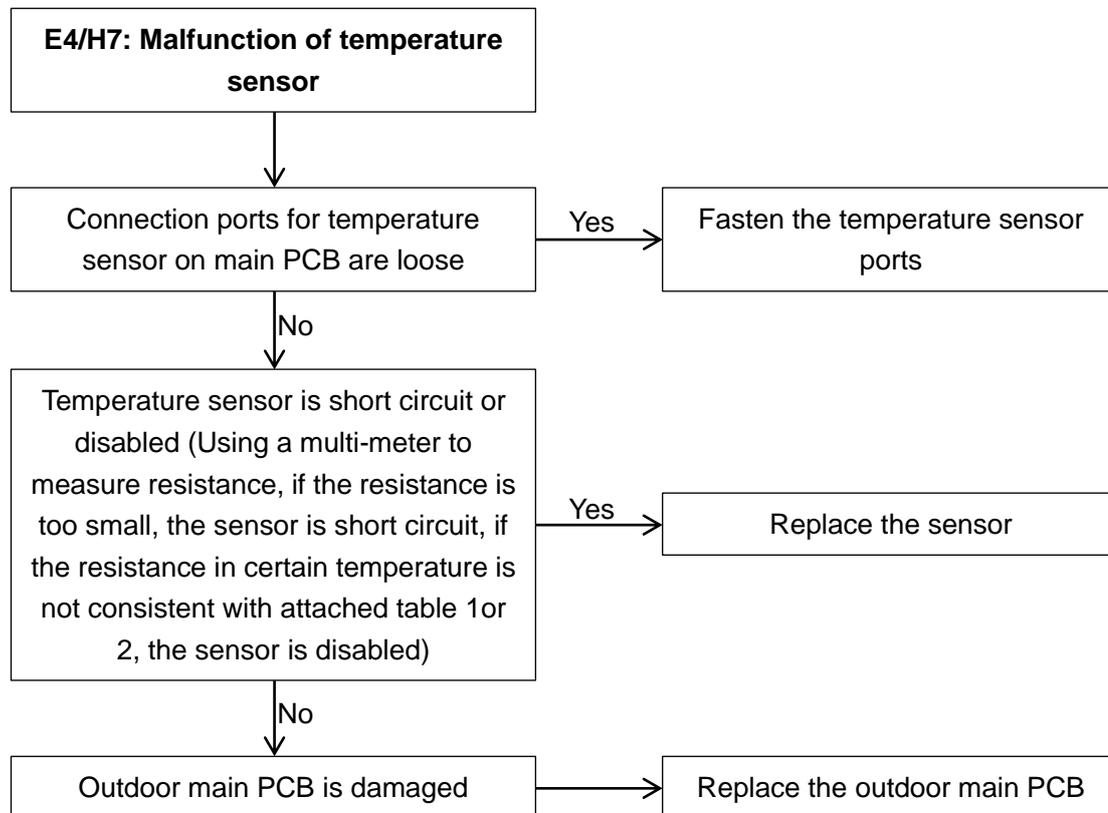

#### 4.6 E5: Malfunction of power supply voltage

The error only display on faulty unit, all the ODU will be standby.

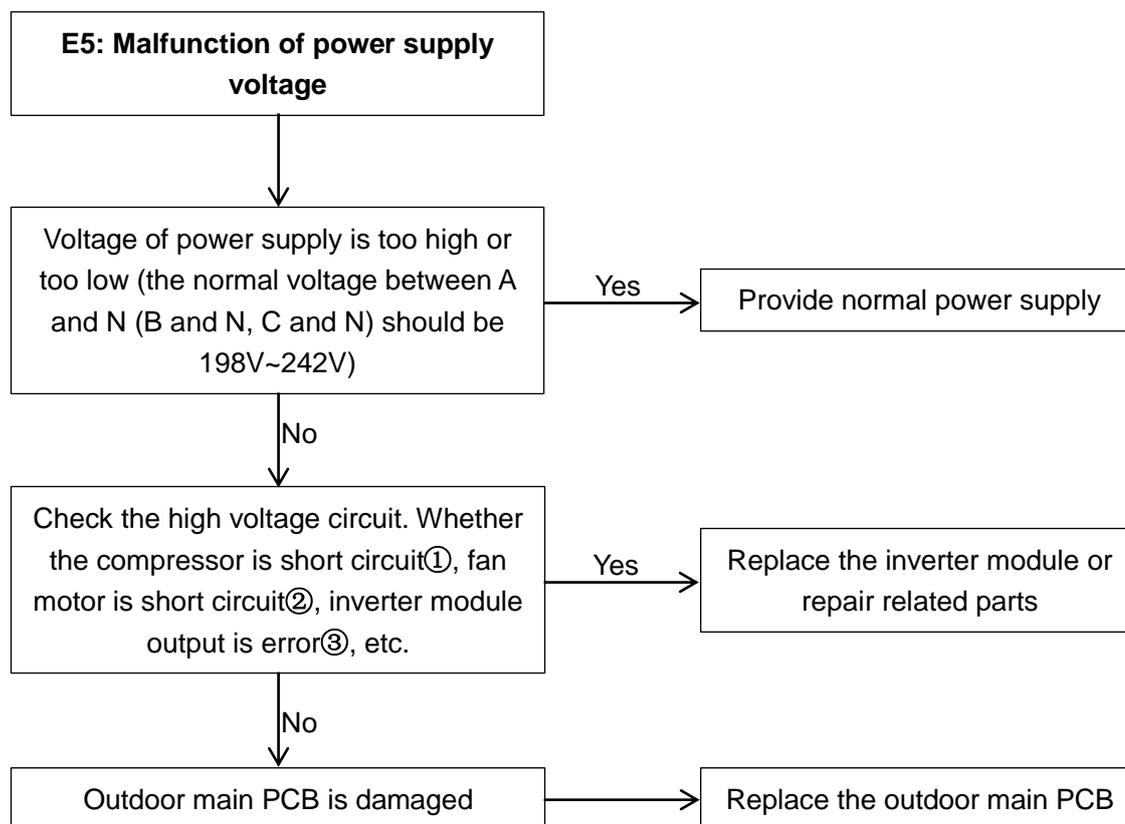

#### Note:

##### 1. How to check whether the compressor is short circuit①:

The normal resistance value of inverter compressor among U V W is 0.7~1.5Ω, and infinity to earth. If the resistance value is out of the range, the compressor is abnormal.

##### 2. How to check whether the fan motor is short circuit②:

The normal value of DC fan motor coil among U V W is less than 10Ω. If the measured value is 0Ω, the fan motor is short circuit.

##### 3. How to check whether the inverter module output is error③:

Let PN and U V W of inverter module short circuit, then dial multi-meter to buzzer file, if the multi-meter is ring, the inverter module output is error.

#### 4.7 E8: Faulty outdoor unit address

The error only display on faulty slave unit, all the ODU will be standby.

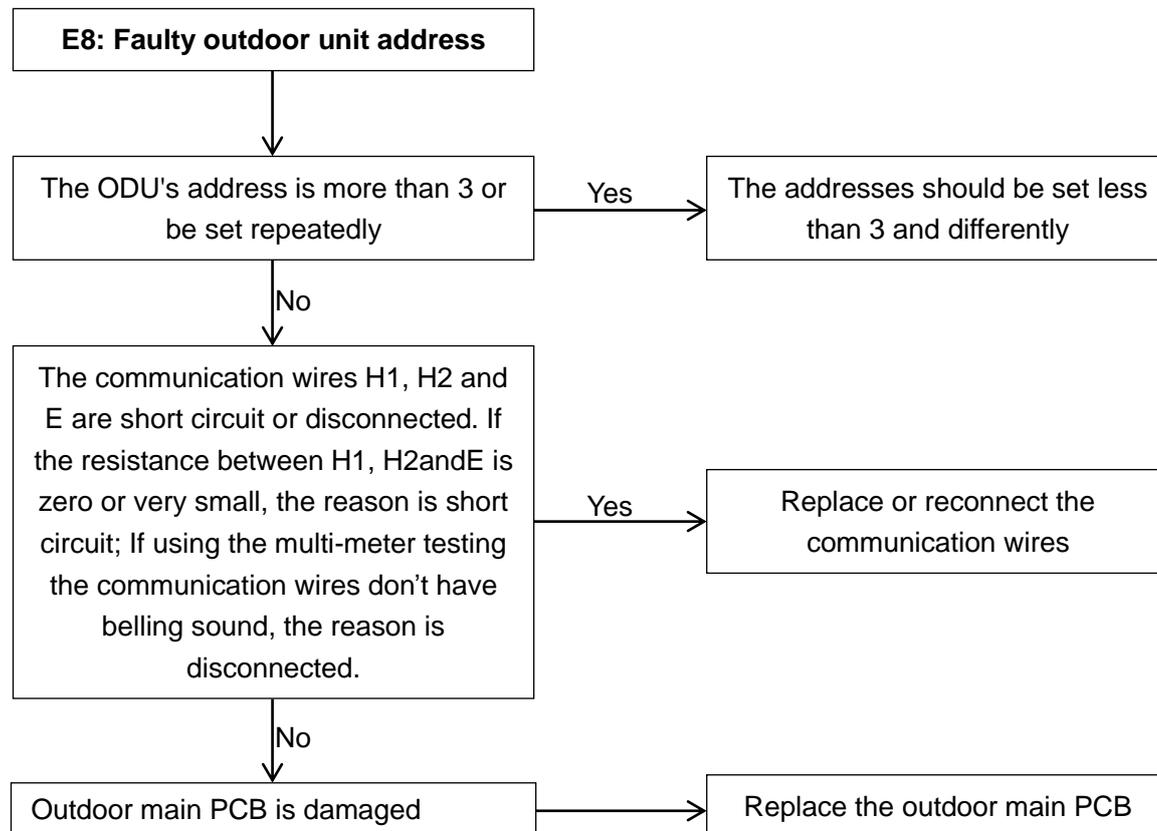

#### 4.8 xE9: Driver model is mismatched (When x is 1, it means A system; 2 means B system)

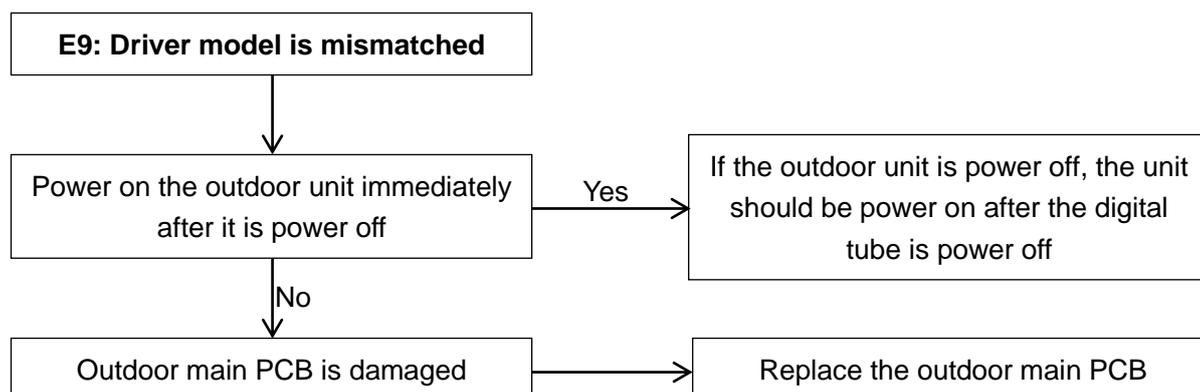

**4.9 xH0: Malfunction of communication between main control chip and inverter driver chip**

**4.10 H1: Malfunction of communication between main control chip and communication chip**

The error only display on faulty unit, all the ODU will be standby.

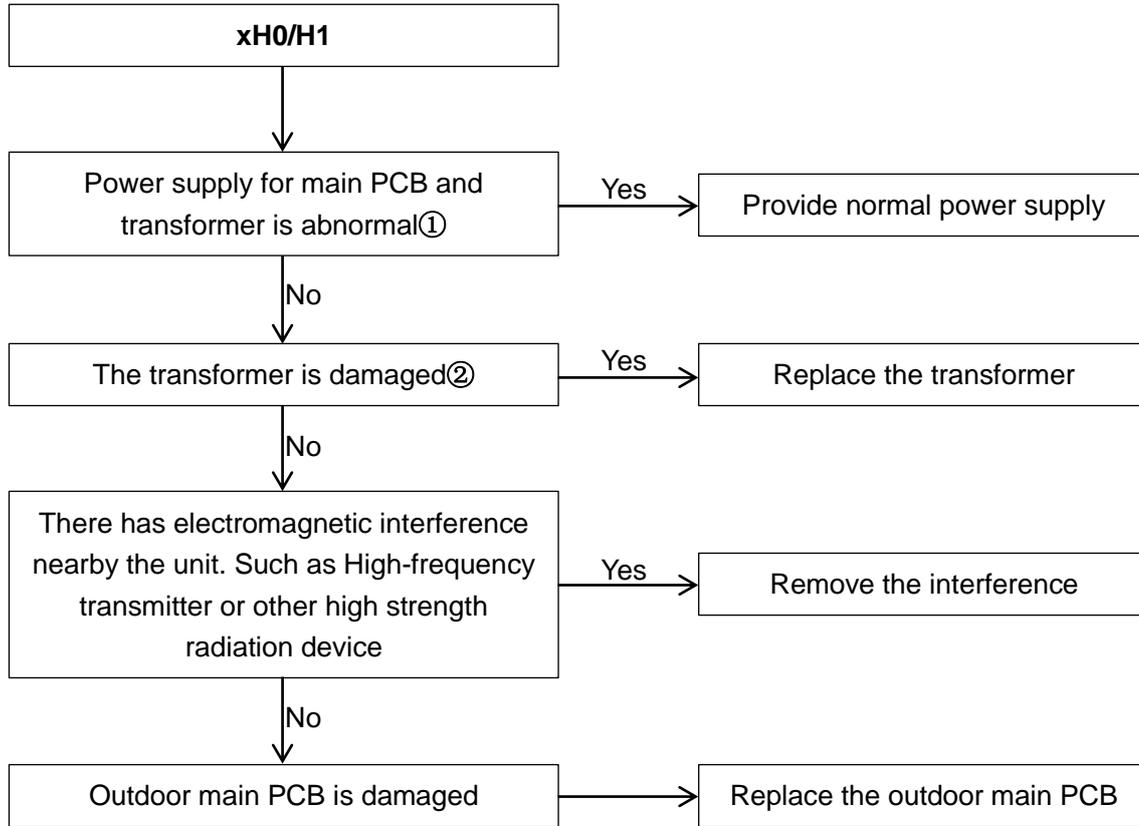

**Note:**

**1. How to check whether power supply for transformer is abnormal①**

Check the voltage of 8(CN31), 9(CN33) and 24(CN35) terminals. The normal voltage of 8(CN31) and 9(CN33) terminals should be 220V, the voltage between “GND” and “5V” of 24(CN35) terminal should be 5V, the voltage between “GND” and “12V” of 24(CN35) terminal should be 12V. If the voltage is out of the range, the power supply for main PCB and transformer is abnormal.

**2. How to check whether the transformer is disabled②**

The voltage between upper tow pins of 18(CN32) terminal is AC 13.5V; the voltage between under tow pins of 18(CN32) terminal is AC 9V. The voltage between upper tow pins of 19(CN34) terminal is AC 14.5V; the voltage between under tow pins of 19(CN34) terminal is AC 14.5V

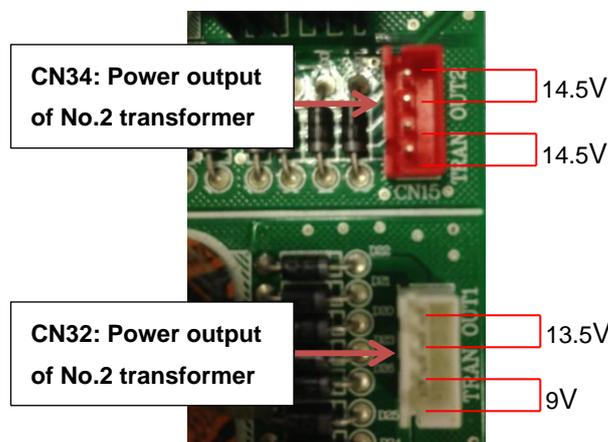

**4.11 H2: Faulty outdoor unit quantity (decreased)****4.12 H3: Faulty outdoor unit quantity (increased)**

The error only display on master unit, all the ODU will be standby.

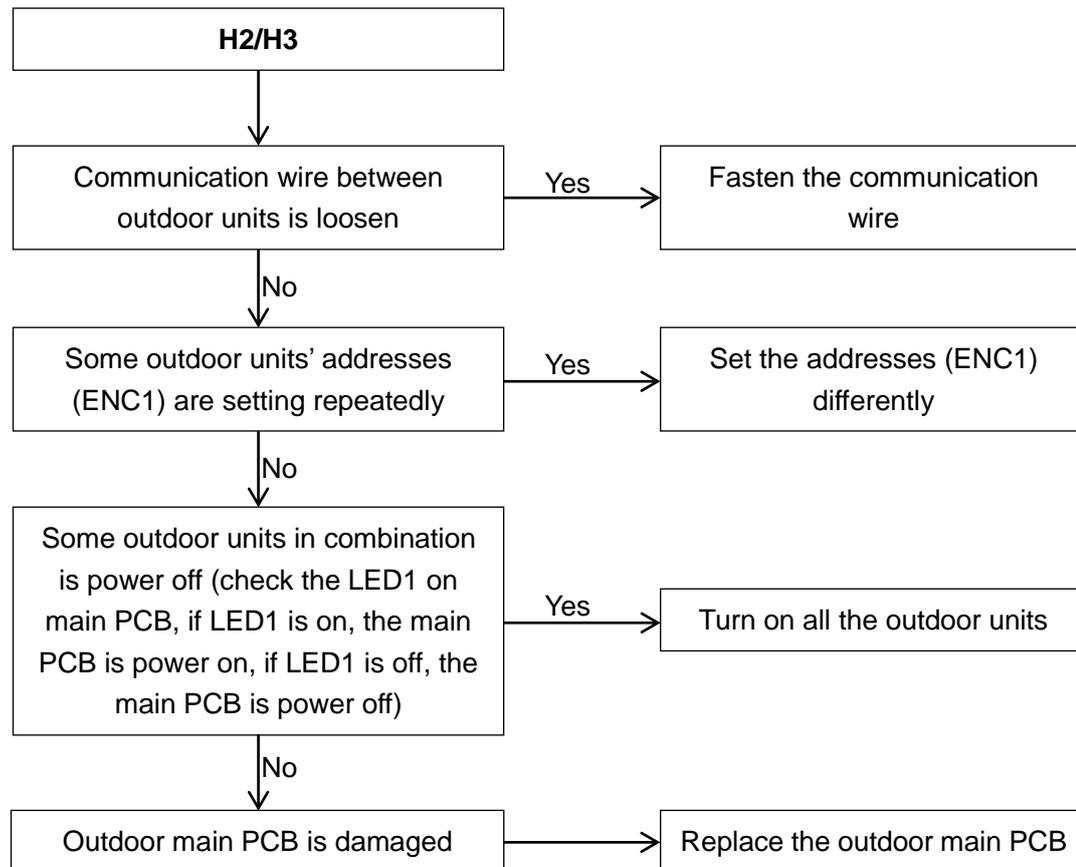

Note: All the outdoor units should be unified power supply. If the outdoor units are not unified power supply, once some outdoor unit is power off, other outdoor units are still running, it may cause system unbalance and damage devices.

### 4.13 H7: Faulty indoor units quantity

The error only display on master unit, all the ODU will be standby. It will display when the quantity of indoor units decrease above 3 minutes.

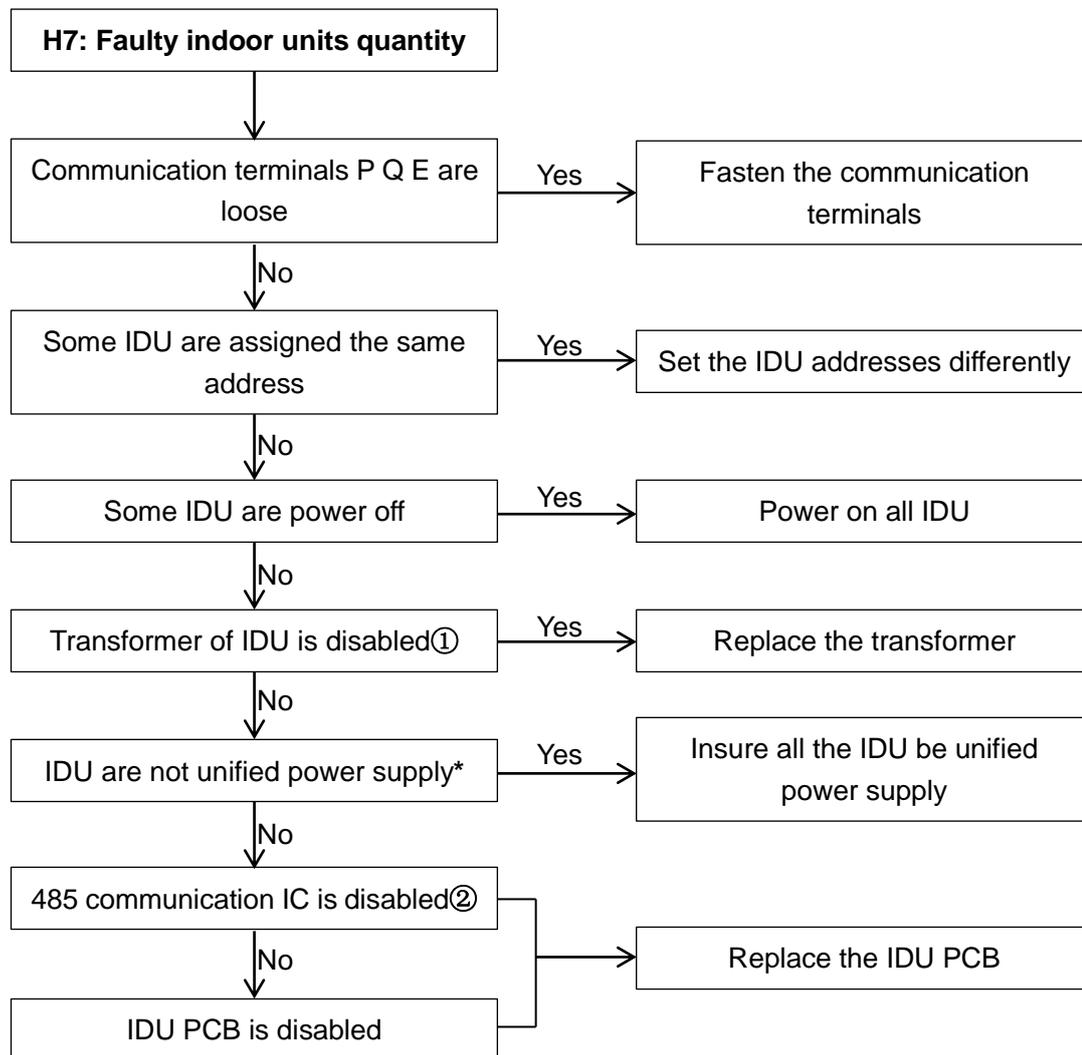

**Note:**

**1. How to check whether the transformer of IDU is disabled①**

The voltage input of IDU transformer is 220V, the voltage output is AC9V (yellow-yellow) and AC13.5V (brown-brown).

**2. How to check whether the 485 communication IC is disabled②**

The normal voltage between “P” and “GND” is DC2.5~2.7V, between “Q” and “GND” is DC2.5~2.7V. If the voltage is out of the normal range, the 485 communication IC is disabled.

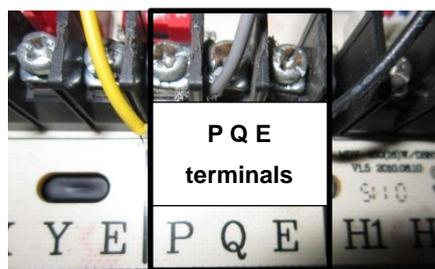

\* Indoor units should be unified power supply, which can prevent compressor from liquid hammer caused by dropped indoor units with EXV unclosed.

#### 4.14 H8: Malfunction of pressure sensor for discharge pipe

When the discharge pressure is lower than 0.3MPa (43.5PSI), the system will display H8 error, the ODU in standby. When the discharge pressure is back to normal, H8 disappears and normal operation resumes.

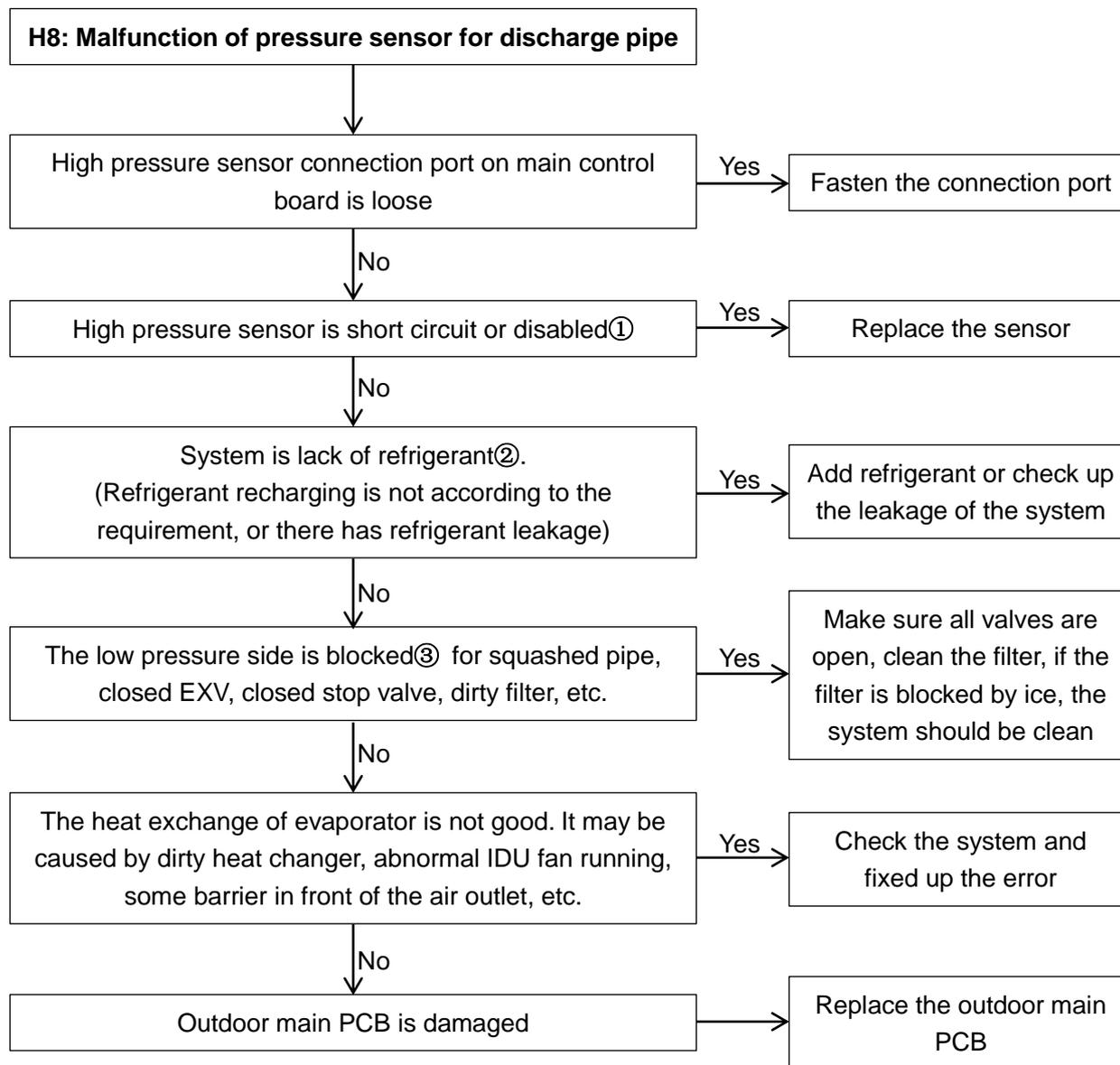

#### Note:

##### 1. How to check whether the high pressure sensor is short circuit or disabled①

Measure the resistance among the three terminals of the pressure sensor, if the resistance value is megohm or infinite, the pressure sensor is disabled, otherwise, it may be normal.

##### 2. The phenomenon of lack of refrigerant②:

Top temperature and discharge temperature of all compressors are higher than normal value, discharge pressure and suction pressure are both lower than normal value, current is lower than normal value, suction pipe may be frosting. All the phenomenon will disappear after recharging refrigerant.

##### 3. The phenomenon of the low pressure side is blocked③:

The discharge temperature is higher than normal value\*, low pressure is lower than normal value\*, current is lower than normal value\* and suction pipe may be frosting.

\*The normal system running parameters please refer to attached table 3.

**4.15 yHd: Slave units malfunction (y stands for corresponding slave unit)**

yHd is only displayed on master unit. y stands for corresponding slave unit. If y is 1, it means No.1 slave unit has problem, then you should check No.1 slave unit.

**4.16 P0: Temperature protection of inverter compressor****4.17 P4: Discharge temperature protection;****4.18 H6: P4 protection appears three times in 100 minutes**

The error only display on faulty unit, all the ODU will be standby.

H6 error cannot resume automatically, and it can resume only by restarting the machine.

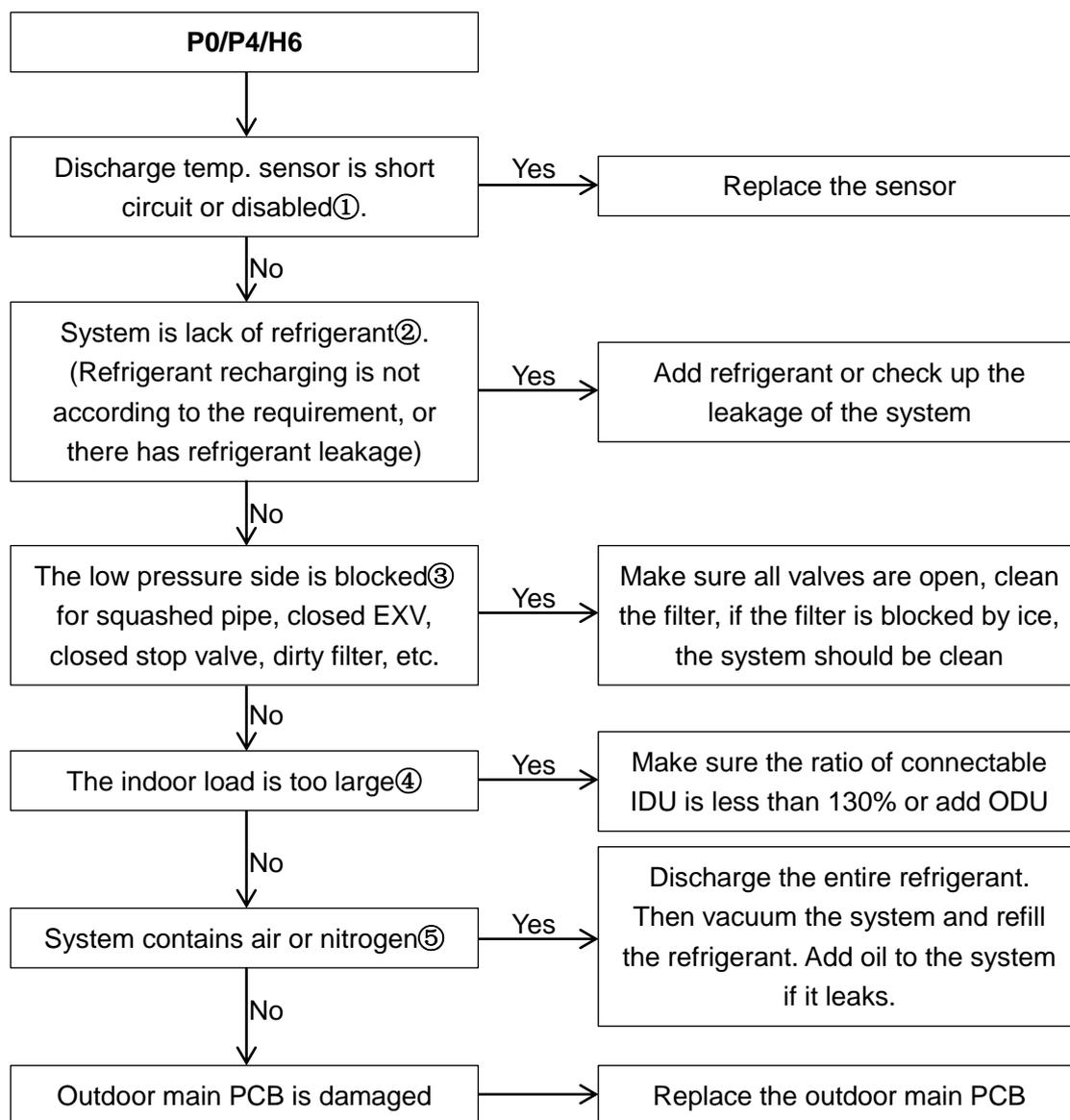
**Note:****1. How to check whether the discharge temperature sensor is short circuit or disabled①:**

Using a multi meter to measure resistance, if the resistance is too small, the sensor is short circuit, if the resistance in certain temperature is not consistent with attached table 2, the sensor is disabled

**2. The phenomenon of lack of refrigerant②:**

Top temperature and discharge temperature of all compressors are higher than normal value, discharge pressure and suction pressure are both lower than normal value, current is lower than normal value, suction pipe may be frosting. All the phenomenon will disappear after recharging refrigerant.



**3. The phenomenon of the low pressure side is blocked③:**

The discharge temperature is higher than normal value\*, low pressure is lower than normal value\*, current is lower than normal value\* and suction pipe may be frosting.

**4. The phenomenon of the indoor load is too large④:**

The suction temperature and discharge temperature are both higher than normal value.

**5. The phenomenon of the system contains air or nitrogen⑤:**

The high pressure is higher than normal value, current is larger than normal value, discharge temperature is higher than normal value, compressor makes noise, pressure meter do not display steady.

\*The normal system running parameters please refer to attached table 3.

**4.19 P1: High pressure protection**

When the pressure is over 4.4MPa, the system will display P1 protection, the ODU in standby. When the pressure is lower than 3.2MPa, P1 disappears and normal operation resumes.

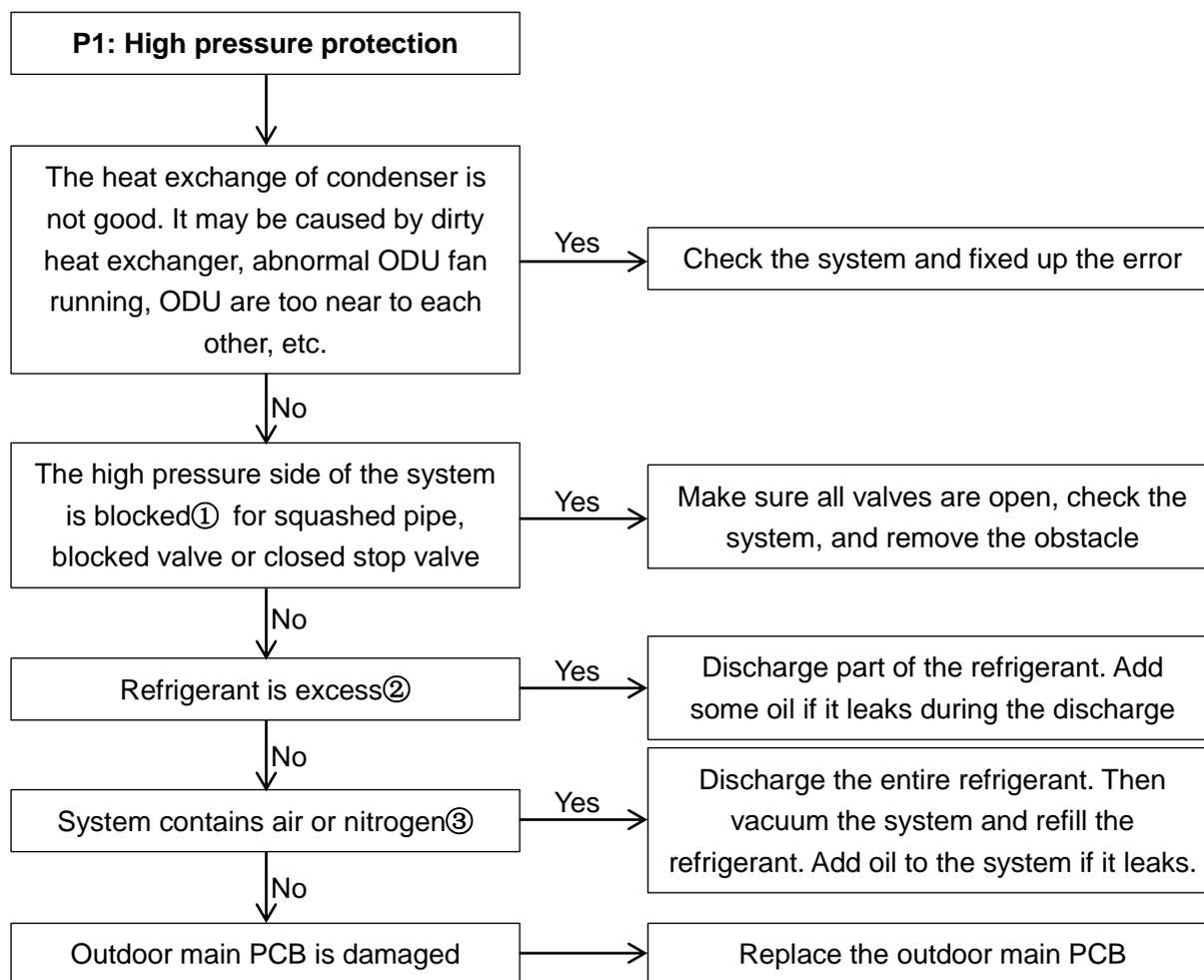

**Note:**

**1. The phenomenon of The high pressure side of the system is blocked①:**

The high pressure is higher than normal value, the low pressure is lower than normal value, and the discharge temperature is higher than normal value.

**2. The phenomenon of the refrigerant is excess②:**

The high pressure is higher than normal value, the low pressure is higher than normal value, and the discharge temperature is lower than normal value.

**3. The phenomenon of the system contains air or nitrogen③:**

The high pressure is higher than normal value, current is larger than normal value, discharge temperature is higher than normal value, compressor makes noise, pressure meter do not display steady.

\*The normal system running parameters please refer to attached table 3.

\*If the system install three-phase protector, and the three-phase protector connect with high pressure switch in series connection, the system will display P1 protection when fist power on, and P1 protection will disappear after system is steady.

\*If the system install three-phase protector, and the three-phase protector connect with low pressure switch in series connection, the system will display P2 protection when fist power on, and P2 protection will disappear after system is steady.

#### 4.20 P2: Low pressure protection

##### 4.21 H5: P2 protection appears three times in 60 minutes

When the pressure is lower than 0.05MPa, the system will display P2 protection, the ODU in standby. When the pressure is higher than 0.15MPa, P2 disappears and resumes normal operation.

H5 error will display when system appear 3 times P2 protection in 60 minutes, it cannot resume automatically, and it can resume only by restarting the machine.

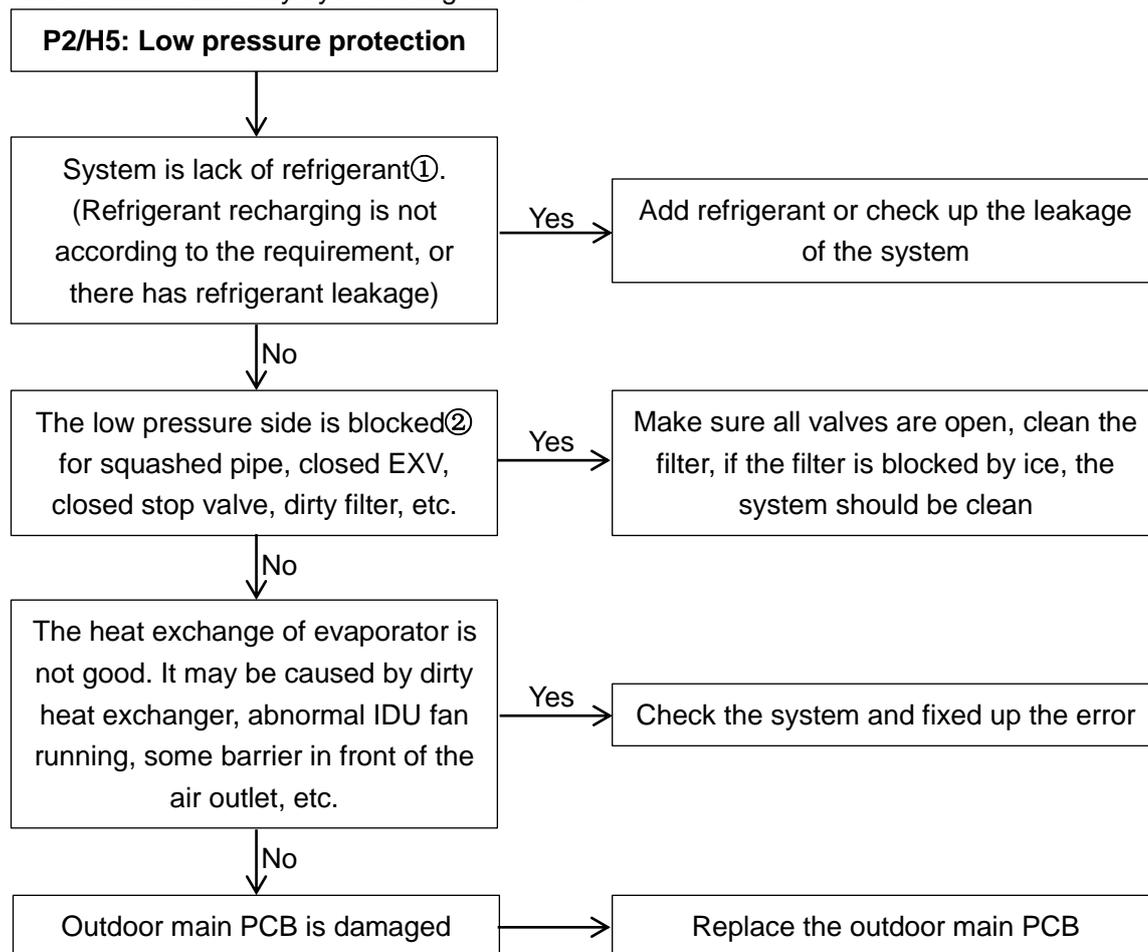

**Note:**

**1. The phenomenon of lack of refrigerant①:**

Top temperature and discharge temperature of all compressors are higher than normal value, discharge pressure and suction pressure are both lower than normal value, current is lower than normal value, suction pipe may be frosting. All the phenomenon will disappear after recharging refrigerant.

**2. The phenomenon of the low pressure side is blocked②:**

The discharge temperature is higher than normal value\*, low pressure is lower than normal value\*, current is lower than normal value\* and suction pipe may be frosting.

\*The normal system running parameters please refer to attached table 3.

\*If the system install three-phase protector, and the three-phase protector connect with high pressure switch in series connection, the system will display P1 protection when fist power on, and P1 protection will disappear after system is steady.

\*If the system install three-phase protector, and the three-phase protector connect with low pressure switch in series connection, the system will display P2 protection when fist power on, and P2 protection will disappear after system is steady.

#### 4.22 xP3: Over current protection of compressor (When x is 1, it means A compressor; 2 means B compressor)

When the current of inverter compressor is over 12A\*, the system will display P3 protection, the ODU in standby. When the current goes back to normal range, P3 disappears and normal operation resumes.

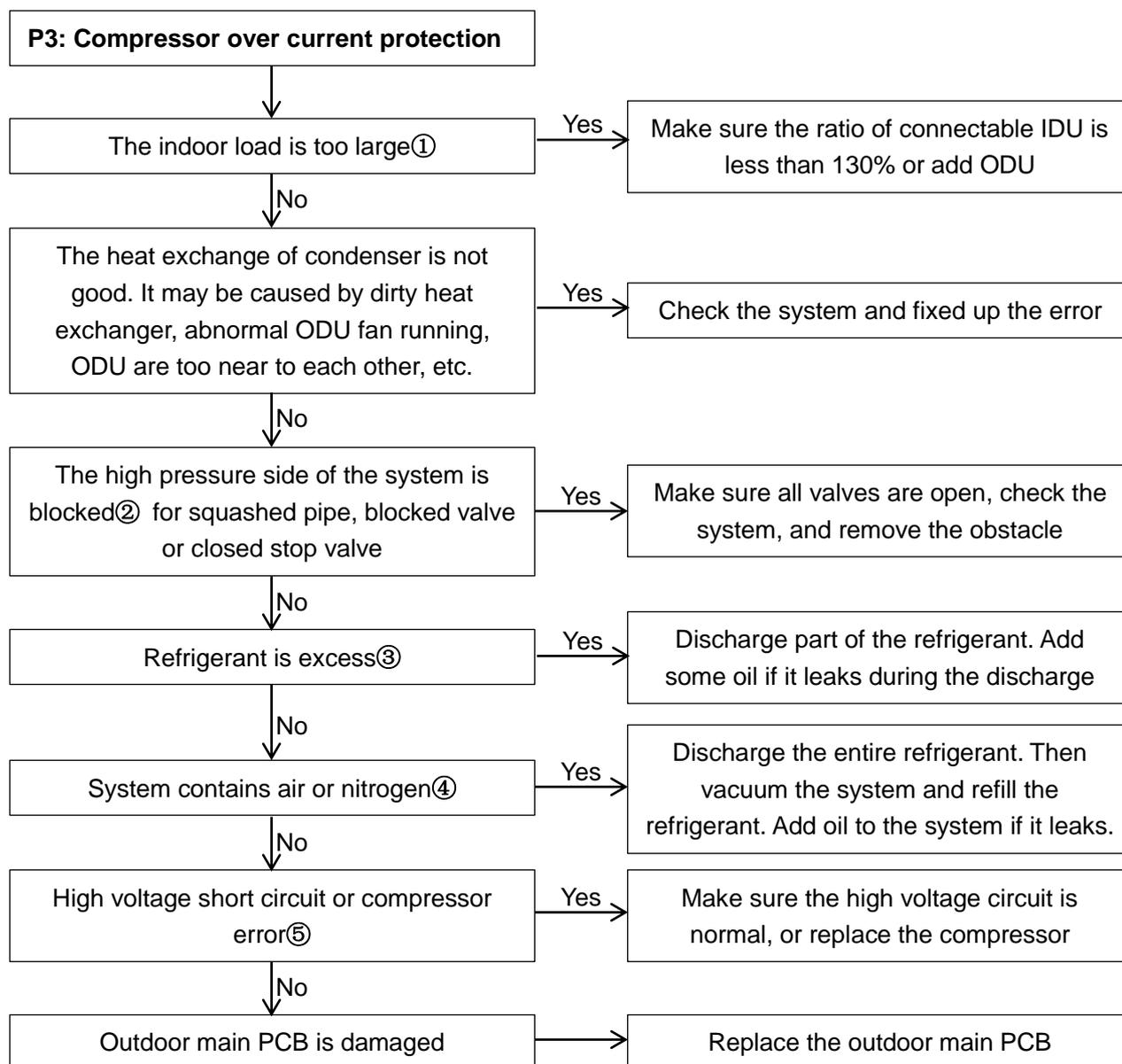

#### Note:

##### 1. The phenomenon of the indoor load is too large①:

The suction temperature and discharge temperature are both higher than normal value.

##### 2. The phenomenon of the high pressure side of the system is blocked②:

The high pressure is higher than normal value, the low pressure is lower than normal value, and the discharge temperature is higher than normal value.

##### 3. The phenomenon of the refrigerant is excess③:

The high pressure is higher than normal value, the low pressure is higher than normal value, and the discharge temperature is lower than normal value.

##### 4. The phenomenon of the system contains air or nitrogen④:

The high pressure is higher than normal value, current is larger than normal value, discharge temperature is higher than normal value, compressor makes noise, pressure meter do not display steady.

##### 5. How to check whether compressor is error⑤:

Measure the resistance between two terminals among the three terminals of compressor. The resistance between two terminals is 2-5Ω, the resistance between each terminal and ground is infinity, if the resistance is out of the normal range, the compressor is error.

\*The protection current of different compressors are as followed: E405DHD-36D2YG, 12A; E405DHD-42D2YG, 15A; E655DHD-65D2YG, 21A; E705DHD-72D2YG, 23A.

### 4.23 P5: Condenser temperature protection

When condenser temperature is over 65°C (149°F), the system will display P5 protection, the ODU in standby. When the temperature goes back to normal range, P5 disappear and normal operation resumes.

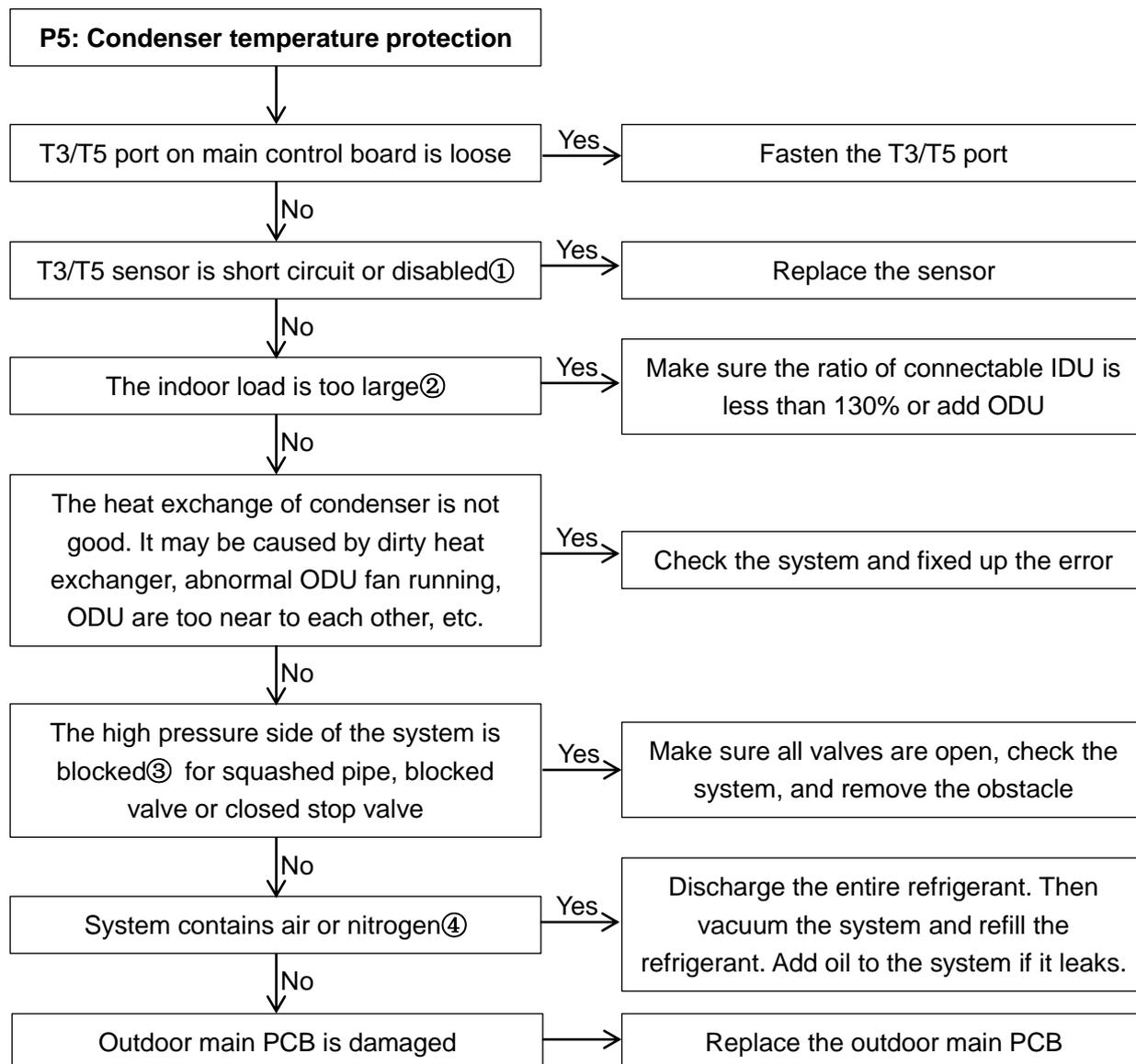

#### Note:

#### T3/T5: Sensor for condenser pipe;

#### 1. How to check whether the T3/T5 sensor is circuit or disabled①:

Using a multi meter to measure resistance, if the resistance is too small, the sensor is short circuit, if the resistance in certain temperature is not consistent with attached table 1, the sensor is disabled

#### 2. The phenomenon of the indoor load is too large②:

The suction temperature and discharge temperature are both higher than normal value.

#### 3. The phenomenon of the high pressure side of the system is blocked③:

The high pressure is higher than normal value, the low pressure is lower than normal value, and the discharge temperature is higher than normal value.

#### 4. The phenomenon of the system contains air or nitrogen④:

The high pressure is higher than normal value, current is larger than normal value, discharge temperature is higher than normal value, compressor makes noise, pressure meter do not display steady.

**4.24 xP6: Inverter module protection (When x is 1, it means A inverter module; 2 means B inverter module)**

**4.25 xH4: P6 protection appears three times in 60 minutes**

When the system displays H4 error code, the system can resume only by restarting the machine. At this time, malfunction should be disposed promptly to avoid further damage.

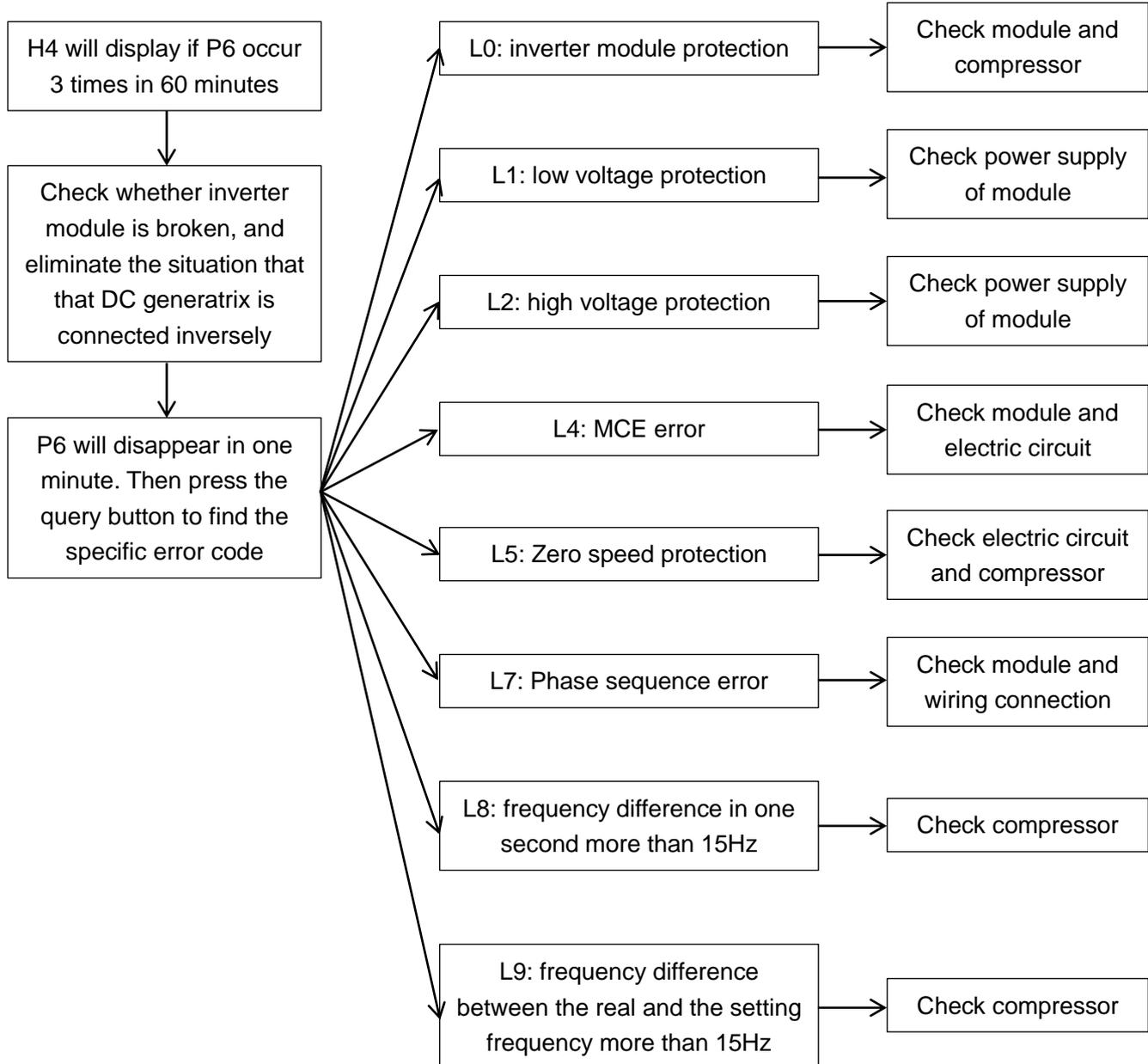

**1) L0 troubleshooting**

**Step 1: Compressor check**

Measure the resistance between each two of U, V, W terminals of the compressor, all the resistance should be the same and equal to 0.9~5 Ohms. (Fig. A and Fig. B)

Measure the resistance between each of U, V, W terminals of the compressor to ground (Fig. C), all the resistance should trend to infinity (Fig. D), otherwise the compressor has been malfunction, needs to be replaced.



Fig. A

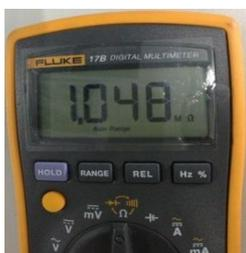

Fig.B



Fig.C



Fig.D

If the resistance values are normal, then go to step 2.

**Step 2: Module check**



- 1) DC voltage between terminal P and terminal N should be 1.41 times of the local power supply voltage.
- 2) DC voltage between terminal 1 and 2 should be 510V~580V.
- 3) Disconnect the terminal 3, 4, and 5 from inverter compressor. Measure the resistance between any two terminals among terminal 1, 2, 3, 4, 5. All the values should be infinity. If any of the value approximates to 0, the inverter module is damaged and should be replaced.

After replaced the inverter module, if the system is still abnormal, then go to step 3.

**Step 3: DC generatrix check**

Direction of the current in DC supply wire which is running through the inductor should be the same as the direction of arrow marked on the inductor.

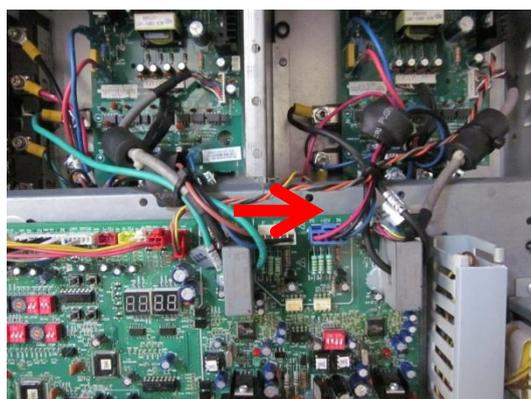

### 2) L1/L4 troubleshooting

Step 1: Check the DC voltage between 1 and 2 terminal, the normal value should be 510V~580V, if the voltage is lower than 510V, go to step 2.

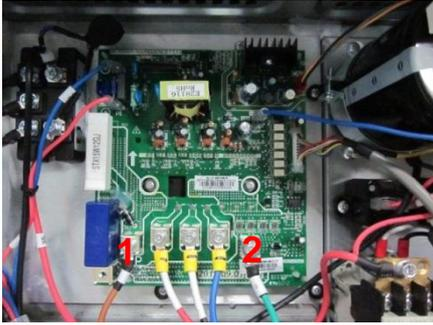

Step 2: Check whether the wires of rectifier circuit are loose or not. If wires are loosen, fasten the wires. If wires are OK, replace the main PCB.

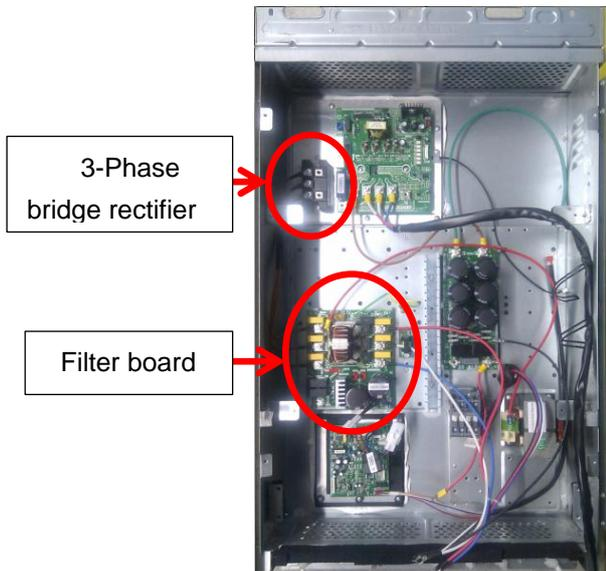

### 3) L2 troubleshooting

Step 1: Check the DC voltage between 1 and 2 terminal, the normal value should be 510V~580V, if the voltage is higher than 580V, go to step 2.

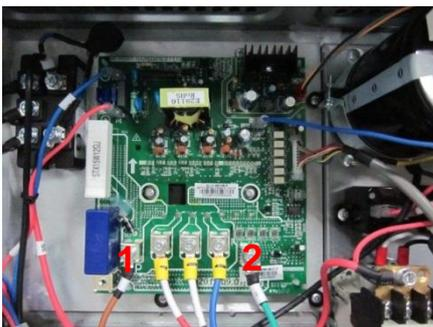

Step 2: Check the voltage between the two electrolytic capacitors, the normal value should be 510V~580V.



Turn the measure range of the meter to 1kV, measure the voltage between two electrolytic capacitors



If the value is not in the range, that means the power supply for electrolytic capacitors has problem, you should check the power supply, whether the voltage is too high and whether the voltage is stable.  
 If the voltage value is normal, then the main PCB has malfunction, it needs to be replaced.

**4) L8/L9 troubleshooting**

**Step 1: Compressor check**

Measure the resistance between each two of U, V, W terminals of the compressor, all the resistance should be the same and equal to 0.9~5 Ohms. (Fig. A and Fig. B)

Measure the resistance between each of U, V, W terminals of the compressor to ground (Fig. C), all the resistance should trend to infinity (Fig. D), otherwise the compressor has been malfunction, needs to be replaced.



Fig. A

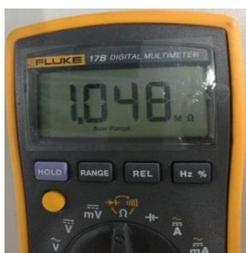

Fig. B



Fig. C



Fig. D

If the resistance values are normal, then go to step 2.

**Step 2:** Disconnect the power wiring from the compressor (named compressor A) of the faulted system (named system A).

**If there is a system running normally nearby** (named system B):

Extend the power line of the inverter compressor of system B, connect compressor A to the control box of system B, make sure that the U, V, W terminals are connected in right order, then start system B.

If compressor A can start normally, that means compressor is OK, the control box of system A is malfunction, then replace the main PCB of system A with correct wire connection.

If compressor A can not start normally, that means compressor A is damaged, needs to be replaced.

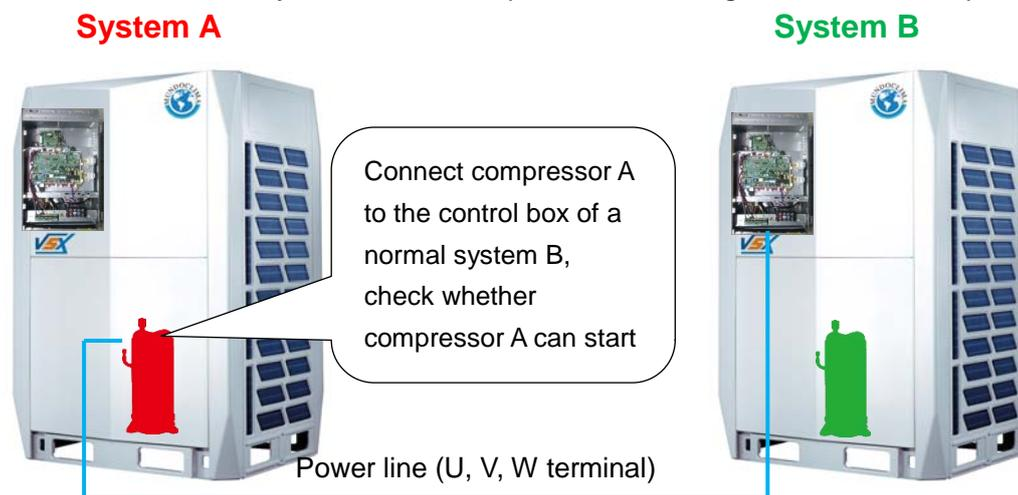

**If there is no normal system nearby:**

Replace the main PCB of system A with correct connection, if compressor A can start normally, it means the main PCB which is replaced is damaged. If compressor A still can't start normally, replace the compressor.



**Guide for compressor replacement**

**Step 1:** Take out the compressor from the faulty outdoor unit, pour out the oil from the compressor according to the method illustrated. Normally the oil will outflow from the discharge pipe of the compressor.



**Step 2:** check the oil of the system

Normally the oil is clear and transparent, if it is a little yellowing, it is also OK. However, if the oil is become black, feculent, or even there is impurity in the oil, that means the system has problems and the oil has gone bad, the oil need to be replaced.

The oil is black, it has been carbonized



The oil is a little yellowing, but it is clear and transparent, the quality is OK

The oil is still transparent, but there is impurity in the oil, the impurity may clog the

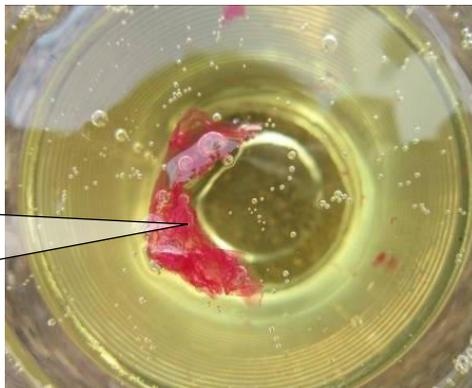

The oil becomes cloudy and gray



The oil contains a lot of copper scrap

If the oil has been bad

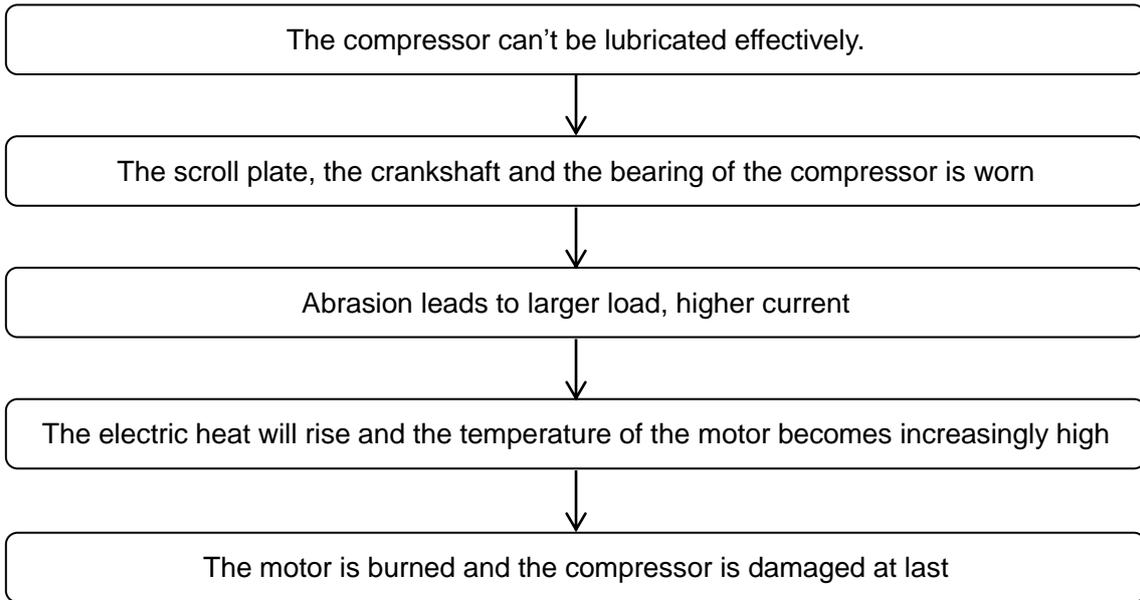

The crankshaft is worn.  
The crankshaft is worn.

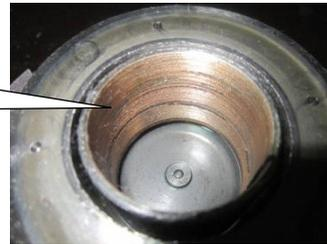

The scroll plate is worn  
The scroll plate is worn



The bearing is worn seriously, it is damaged completely

A normal bearing of the compressor



A clean filter (on the suction pipe of the system)

The filter is blocked by impurity; the suction of the compressor will be abnormal

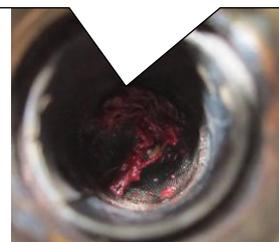
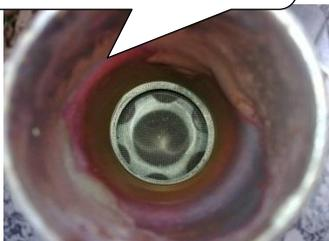

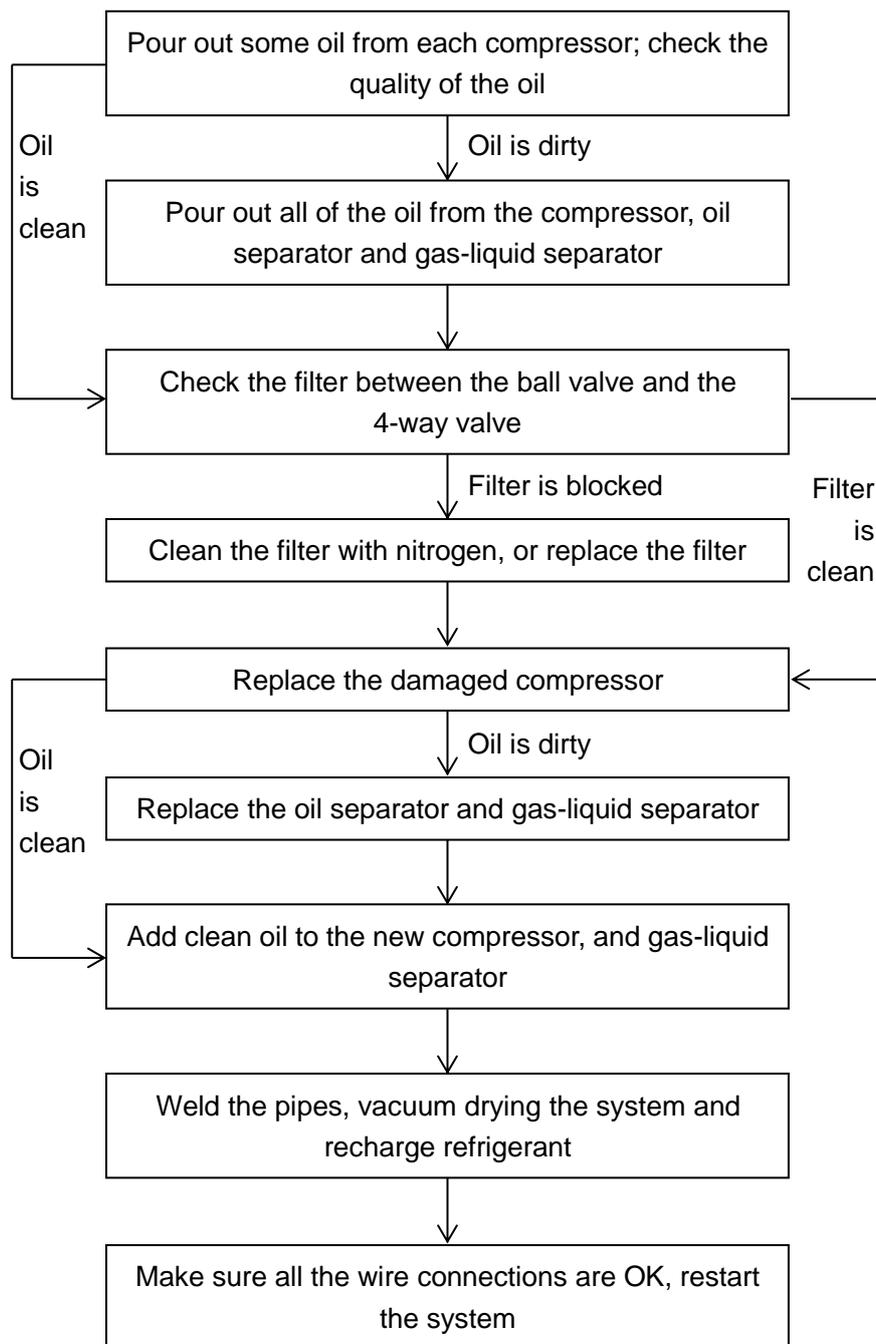
**Step 3:** Replace the compressor**Note:**

1. Before pouring out the oil, shake the compressor, oil separator and gas-liquid separator first, because impurity may deposit at the bottom of the tank.
2. If the oil of one compressor is clean, there's no need to check the oil of the other compressor. If the oil of one compressor has gone bad, check the oil of the other compressor is necessary. If all the oil of an outdoor unit needs to be replaced, after adding oil to the compressors, the rest oil should be charged to the gas-liquid separator.
3. Add oil to the compressor from the discharge pipe.

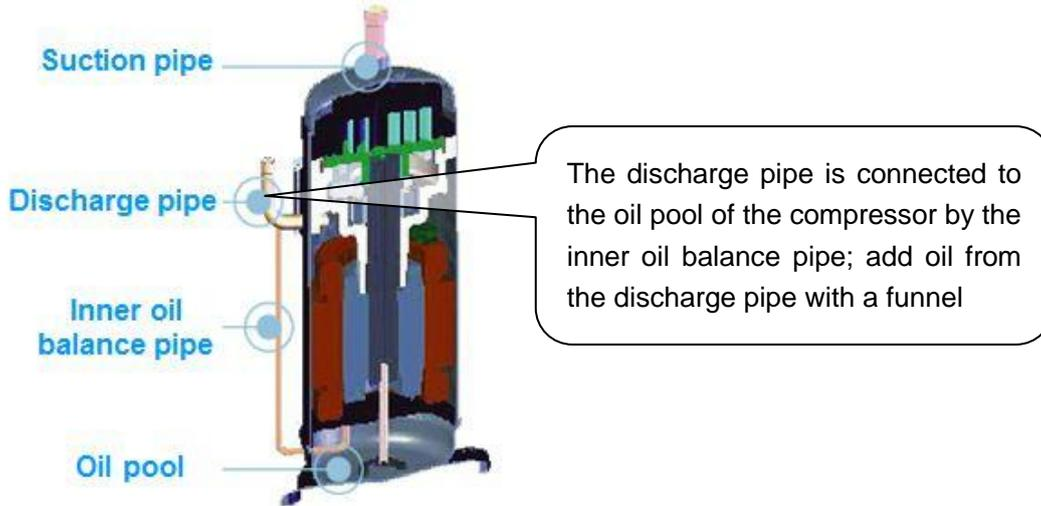

4. The type of the oil is FVC-68D, make sure the type of the oil is right because different compressor need different type of oil, if the type is wrong there will be various kinds of problems.

**4.26 P9: Fan module protection**

**4.27 H9: P9 protection appears three times in 60 minutes**

If the system display three times P9 protection in 60 minutes, the system will stop and display H9 error code. When the system displays H9 error code, the system can resume only by restarting the machine. At this time, malfunction should be disposed promptly to avoid further damage.

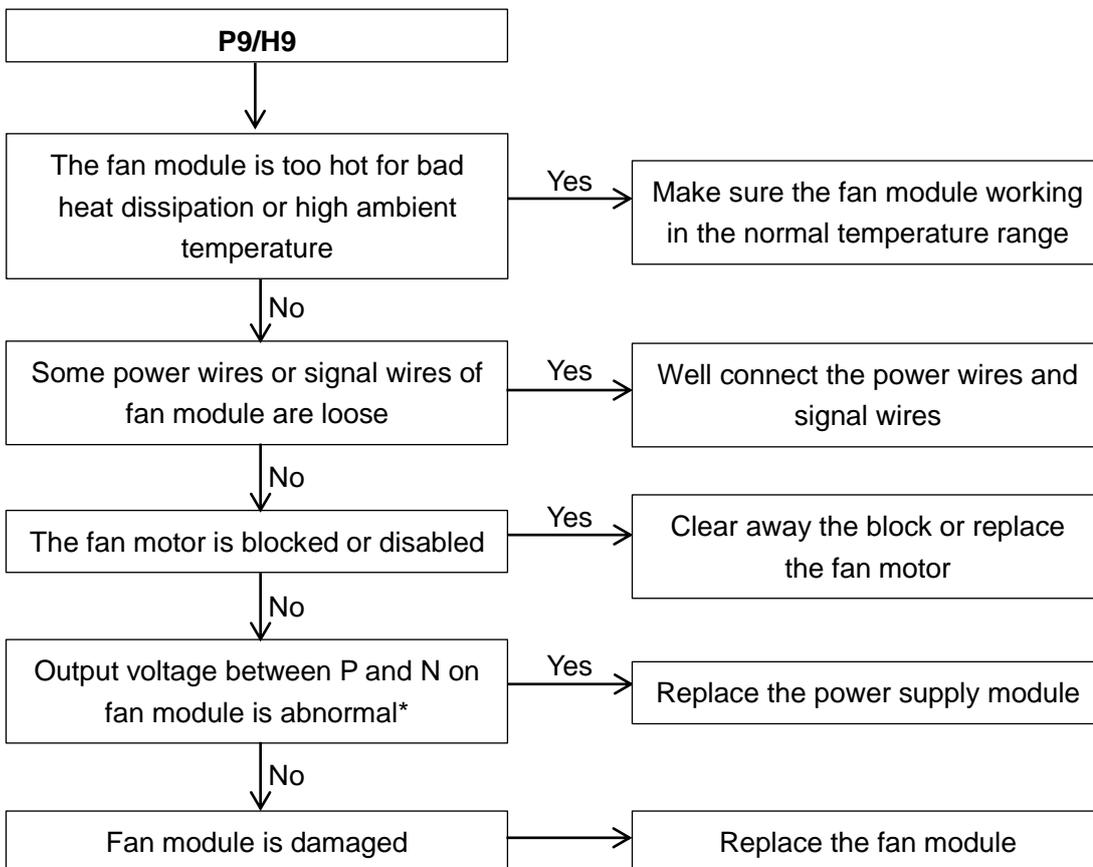

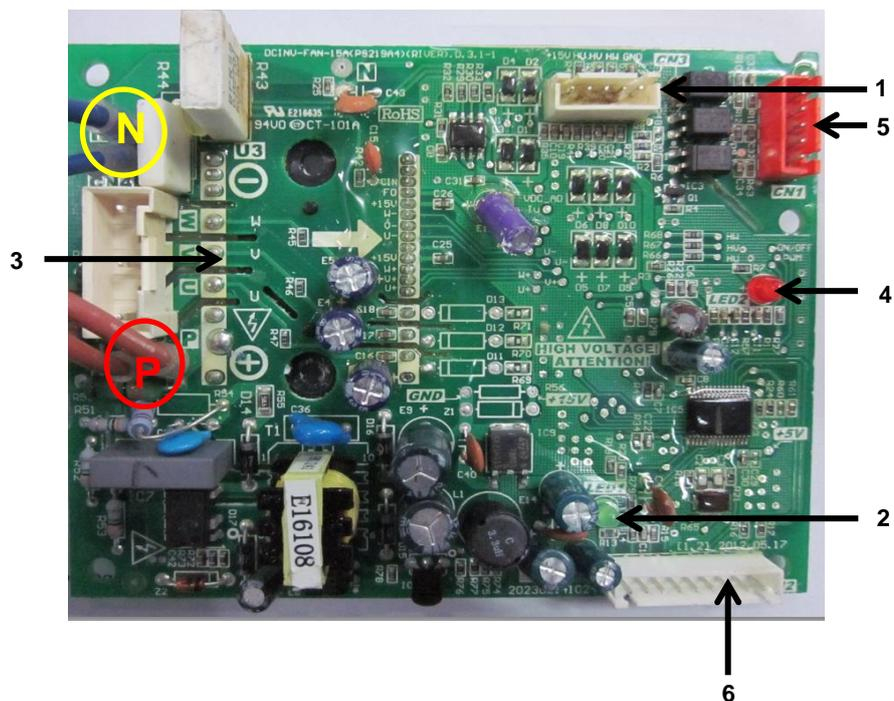

- 1 Program input port
- 2 Power supply indicator lamp
- 3 Fan motor U, V, W output port
- 4 Fault indicator lamp
- 5 PCB control signal input port
- 6 Signal feedback port

\*The normal value of output voltage between P and N on fan module is DC 310V

**P9 protection analysis**

Conditions	Fault indicator lamp of fan module	Power supply indicator lamp of fan module	Digital tube display	Malfunction analysis
Power on	Off	Off	Quantity of IDU or "0"	Check the power supply circuit for fan module. Check whether there has power supply for lightning protection plate, whether the protective tube is broken, whether the voltage after rectification is normal, whether the bridge rectifier is broken.
Power on	Off	Flash	Quantity of IDU or "0"	Power supply of fan module has problem, needs to replace the fan module.
When fan motor start	At first the lamp is on then the lamp is off	On	P9/H9	Check whether the drive port and signal feedback port is loose, whether the fan module and fan motor is installed firmly. If above conditions are all OK, it needs to replace the fan module.
When fan motor start	At first the lamp is on then the lamp flash	On	P9/H9	Check whether the transformer in lightning protection plate is open circuit, whether the relay is broken. If occurs above problem, it needs to replace the lightning protection plate.
Fan motor running several minutes	On	On	P9/H9	Check whether the capacity setting from dial switch is accordance with actual ODU capacity, whether the capacity from query button is accordance with actual ODU capacity. If occurs above problem, it needs to adjust the capacity setting. If above conditions are both OK, it needs to replace the main control board.

**4.28 PL: Temperature protection of main inverter module**

**4.29 C7: PL protection appears three times in 100 minutes**

When the temperature of inverter module is over 80°C, it will display PL protection.

If the system display three times PL protection in 100 minutes, the system will stop and display C7 error code.

When the system displays C7 error code, the system can resume only by restarting the machine.

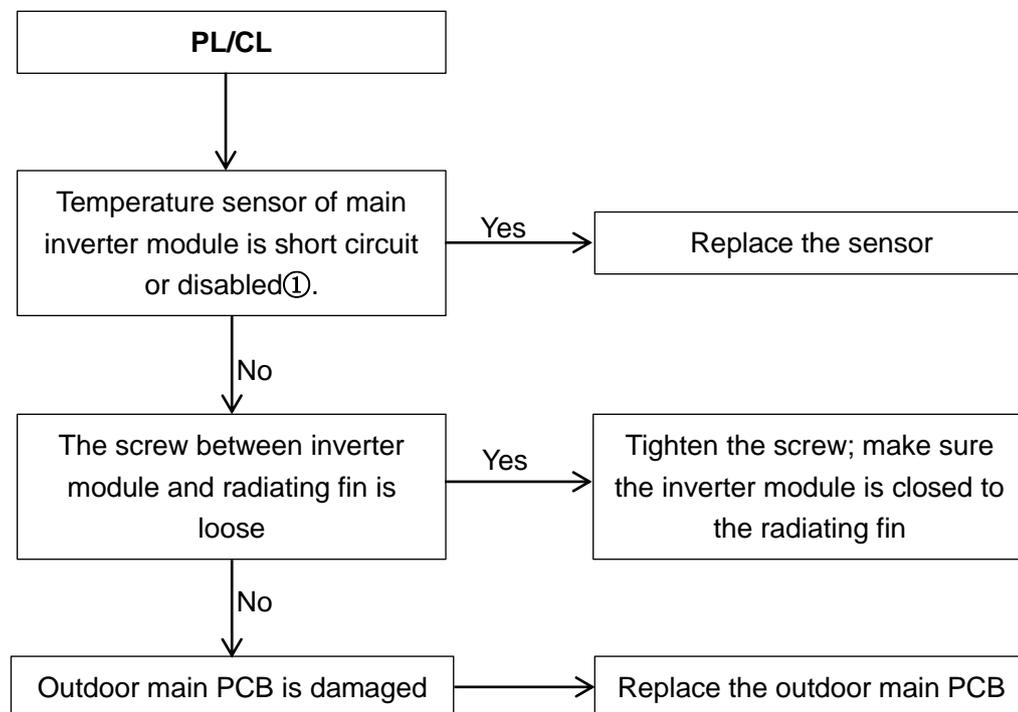

**1. How to check whether the temperature sensor is short circuit or disabled①:**

Using a multi-meter to measure resistance, if the resistance is too small, the sensor is short circuit, if the resistance in certain temperature is not consistent with attached table 2, the sensor is disabled

**4.30 PP: Insufficient overheat degree protection of compressor discharge temperature**

**4.31 F0: PP protection appears three times in 150 minutes**

When the discharge temperature overheat degree is  $\leq 0^{\circ}\text{C}$  for 20min; or the overheat degree is  $\leq 5^{\circ}\text{C}$  for 60min, it will display PP protection.

If the system display three times PP protection in 150 minutes, the system will stop and display F0 error code. When the system displays F0 error code, the system can resume only by restarting the machine.

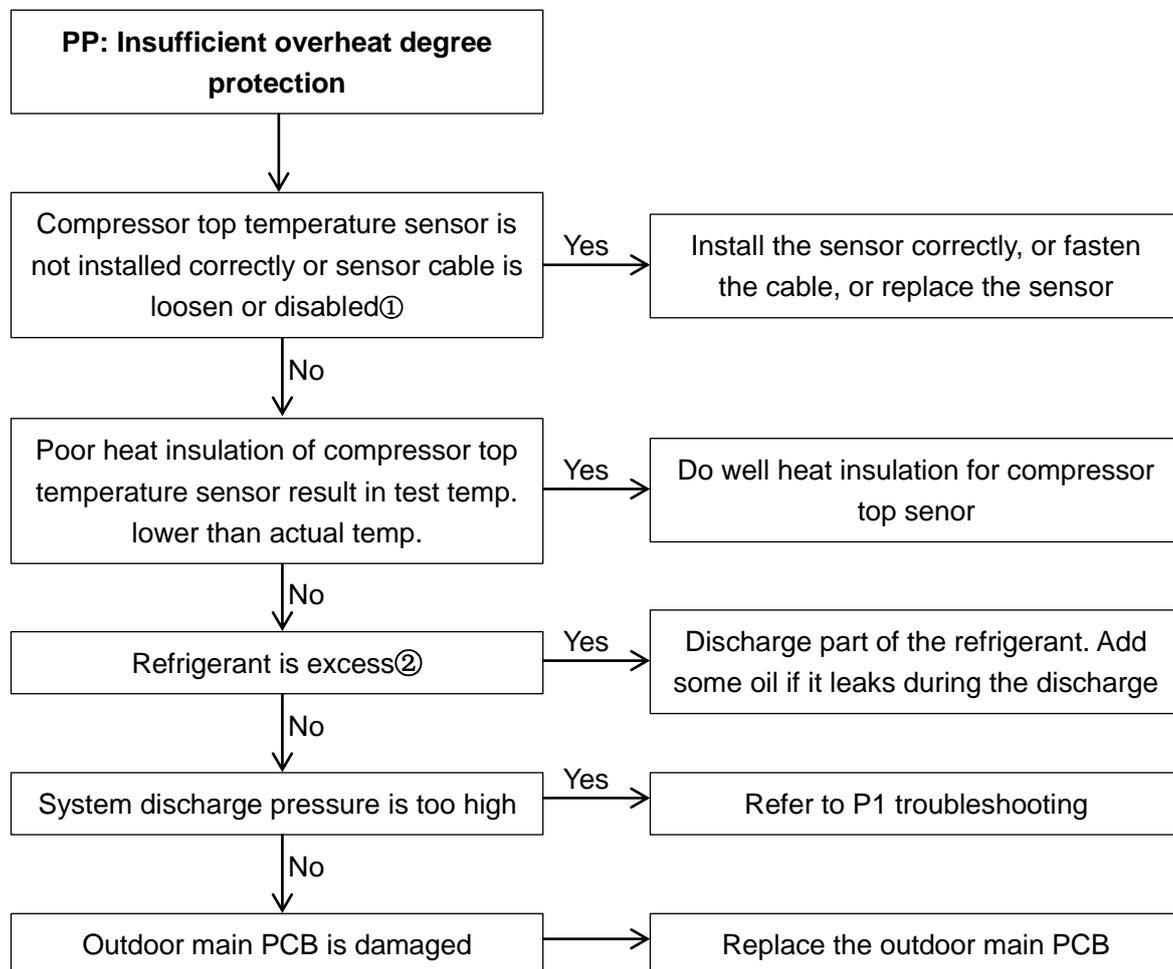

**Note:**

**1. How to check whether the temperature sensor is short circuit or disabled①:**

Using a multi-meter to measure resistance, if the resistance is too small, the sensor is short circuit, if the resistance in certain temperature is not consistent with attached table 2, the sensor is disabled.

**2. The phenomenon of the refrigerant is excess②:**

The high pressure is higher than normal value, the low pressure is higher than normal value, and the discharge temperature is lower than normal value.

**Attached table 1: Resistance characteristic of ambient temperature and pipe temperature sensor**

Temperature °C (°F)	Resistance value (kΩ)	Temperature °C (°F)	Resistance value (kΩ)	Temperature °C (°F)	Resistance value (kΩ)	Temperature °C (°F)	Resistance value (kΩ)
-20(-4)	115.266	20(68)	12.6431	60(140)	2.35774	100(212)	0.62973
-19(-2.2)	108.146	21(69.8)	12.0561	61(141.8)	2.27249	101(213.8)	0.61148
-18(-0.4)	101.517	22(71.6)	11.5	62(143.6)	2.19073	102(215.6)	0.59386
-17(1.4)	96.3423	23(73.4)	10.9731	63(145.4)	2.11241	103(217.4)	0.57683
-16(3.2)	89.5865	24(75.2)	10.4736	64(147.2)	2.03732	104(219.2)	0.56038
-15(5)	84.219	25(77)	10	65(149)	1.96532	105(221)	0.54448
-14(6.8)	79.311	26(78.8)	9.55074	66(150.8)	1.89627	106(222.8)	0.52912
-13(8.6)	74.536	27(80.6)	9.12445	67(152.6)	1.83003	107(224.6)	0.51426
-12(10.4)	70.1698	28(82.4)	8.71983	68(154.4)	1.76647	108(226.4)	0.49989
-11(12.2)	66.0898	29(84.2)	8.33566	69(156.2)	1.70547	109(228.2)	0.486
-10(14)	62.2756	30(86)	7.97078	70(158)	1.64691	110(230)	0.47256
-9(15.8)	58.7079	31(87.8)	7.62411	71(159.8)	1.59068	111(231.8)	0.45957
-8(17.6)	56.3694	32(89.6)	7.29464	72(161.6)	1.53668	112(233.6)	0.44699
-7(19.4)	52.2438	33(91.4)	6.98142	73(163.4)	1.48481	113(235.4)	0.43482
-6(21.2)	49.3161	34(93.2)	6.68355	74(165.2)	1.43498	114(237.2)	0.42304
-5(23)	46.5725	35(95)	6.40021	75(167)	1.38703	115(239)	0.41164
-4(24.8)	44	36(96.8)	6.13059	76(168.8)	1.34105	116(240.8)	0.4006
-3(26.6)	41.5878	37(98.6)	5.87359	77(170.6)	1.29078	117(242.6)	0.38991
-2(28.4)	39.8239	38(100.4)	5.62961	78(172.4)	1.25423	118(244.4)	0.37956
-1(30.2)	37.1988	39(102.2)	5.39689	79(174.2)	1.2133	119(246.2)	0.36954
0(32)	35.2024	40(104)	5.17519	80(176)	1.17393	120(248)	0.35982
1(33.8)	33.3269	41(105.8)	4.96392	81(177.8)	1.13604	121(249.8)	0.35042
2(35.6)	31.5635	42(107.6)	4.76253	82(179.6)	1.09958	122(251.6)	0.3413
3(37.4)	29.9058	43(109.4)	4.5705	83(181.4)	1.06448	123(253.4)	0.33246
4(39.2)	28.3459	44(111.2)	4.38736	84(183.2)	1.03069	124(255.2)	0.3239
5(41)	26.8778	45(113)	4.21263	85(185)	0.99815	125(257)	0.31559
6(42.8)	25.4954	46(114.8)	4.04589	86(186.8)	0.96681	126(258.8)	0.30754
7(44.6)	24.1932	47(116.6)	3.88673	87(188.6)	0.93662	127(260.6)	0.29974
8(46.4)	22.5662	48(118.4)	3.73476	88(190.4)	0.90753	128(262.4)	0.29216
9(48.2)	21.8094	49(120.2)	3.58962	89(192.2)	0.8795	129(264.2)	0.28482
10(50)	20.7184	50(122)	3.45097	90(194)	0.85248	130(266)	0.2777
11(51.8)	19.6891	51(123.8)	3.31847	91(195.8)	0.82643	131(267.8)	0.27078
12(53.6)	18.7177	52(125.6)	3.19183	92(197.6)	0.80132	132(269.6)	0.26408
13(55.4)	17.8005	53(127.4)	3.07075	93(199.4)	0.77709	133(271.4)	0.25757
14(57.2)	16.9341	54(129.2)	2.95896	94(201.2)	0.75373	134(273.2)	0.25125
15(59)	16.1156	55(131)	2.84421	95(203)	0.73119	135(275)	0.24512
16(60.8)	15.3418	56(132.8)	2.73823	96(204.8)	0.70944	136(276.8)	0.23916
17(62.6)	14.6181	57(134.6)	2.63682	97(206.6)	0.68844	137(278.6)	0.23338
18(64.4)	13.918	58(136.4)	2.53973	98(208.4)	0.66818	138(280.4)	0.22776
19(66.2)	13.2631	59(138.2)	2.44677	99(210.2)	0.64862	139(282.2)	0.22231



**Attached table 2: Resistance characteristic of compressor discharge temperature sensor**

Temperature °C (°F)	Resistance value (kΩ)	Temperature °C (°F)	Resistance value (kΩ)	Temperature °C (°F)	Resistance value (kΩ)	Temperature °C (°F)	Resistance value (kΩ)
-20(-4)	542.7	20(68)	68.66	60(140)	13.59	100(212)	3.702
-19(-2.2)	511.9	21(69.8)	65.62	61(141.8)	13.11	101(213.8)	3.595
-18(-0.4)	483	22(71.6)	62.73	62(143.6)	12.65	102(215.6)	3.492
-17(1.4)	455.9	23(73.4)	59.98	63(145.4)	12.21	103(217.4)	3.392
-16(3.2)	430.5	24(75.2)	57.37	64(147.2)	11.79	104(219.2)	3.296
-15(5)	406.7	25(77)	54.89	65(149)	11.38	105(221)	3.203
-14(6.8)	384.3	26(78.8)	52.53	66(150.8)	10.99	106(222.8)	3.113
-13(8.6)	363.3	27(80.6)	50.28	67(152.6)	10.61	107(224.6)	3.025
-12(10.4)	343.6	28(82.4)	48.14	68(154.4)	10.25	108(226.4)	2.941
-11(12.2)	325.1	29(84.2)	46.11	69(156.2)	9.902	109(228.2)	2.86
-10(14)	307.7	30(86)	44.17	70(158)	9.569	110(230)	2.781
-9(15.8)	291.3	31(87.8)	42.33	71(159.8)	9.248	111(231.8)	2.704
-8(17.6)	275.9	32(89.6)	40.57	72(161.6)	8.94	112(233.6)	2.63
-7(19.4)	261.4	33(91.4)	38.89	73(163.4)	8.643	113(235.4)	2.559
-6(21.2)	247.8	34(93.2)	37.3	74(165.2)	8.358	114(237.2)	2.489
-5(23)	234.9	35(95)	35.78	75(167)	8.084	115(239)	2.422
-4(24.8)	222.8	36(96.8)	34.32	76(168.8)	7.82	116(240.8)	2.357
-3(26.6)	211.4	37(98.6)	32.94	77(170.6)	7.566	117(242.6)	2.294
-2(28.4)	200.7	38(100.4)	31.62	78(172.4)	7.321	118(244.4)	2.233
-1(30.2)	190.5	39(102.2)	30.36	79(174.2)	7.086	119(246.2)	2.174
0(32)	180.9	40(104)	29.15	80(176)	6.859	120(248)	2.117
1(33.8)	171.9	41(105.8)	28	81(177.8)	6.641	121(249.8)	2.061
2(35.6)	163.3	42(107.6)	26.9	82(179.6)	6.43	122(251.6)	2.007
3(37.4)	155.2	43(109.4)	25.86	83(181.4)	6.228	123(253.4)	1.955
4(39.2)	147.6	44(111.2)	24.85	84(183.2)	6.033	124(255.2)	1.905
5(41)	140.4	45(113)	23.89	85(185)	5.844	125(257)	1.856
6(42.8)	133.5	46(114.8)	22.89	86(186.8)	5.663	126(258.8)	1.808
7(44.6)	127.1	47(116.6)	22.1	87(188.6)	5.488	127(260.6)	1.762
8(46.4)	121	48(118.4)	21.26	88(190.4)	5.32	128(262.4)	1.717
9(48.2)	115.2	49(120.2)	20.46	89(192.2)	5.157	129(264.2)	1.674
10(50)	109.8	50(122)	19.69	90(194)	5	130(266)	1.632
11(51.8)	104.6	51(123.8)	18.96	91(195.8)	4.849		
12(53.6)	99.69	52(125.6)	18.26	92(197.6)	4.703		
13(55.4)	95.05	53(127.4)	17.58	93(199.4)	4.562		
14(57.2)	90.66	54(129.2)	16.94	94(201.2)	4.426		
15(59)	86.49	55(131)	16.32	95(203)	4.294	B(25/50)=3950K	
16(60.8)	82.54	56(132.8)	15.73	96(204.8)	4.167		
17(62.6)	78.79	57(134.6)	15.16	97(206.6)	4.045	R(90°C)=5KΩ+3%	
18(64.4)	75.24	58(136.4)	14.62	98(208.4)	3.927		
19(66.2)	71.86	59(138.2)	14.09	99(210.2)	3.812		

**Attached table 3: Commissioning and operating parameters of refrigerant system**

**Conditions 1:** Make sure outdoor unit can detect all the indoor units, the quantity of indoor units display steadily and be equal to actual quantity of installed indoor units.

**Conditions 2:** Make sure all the valves in outdoor unit are open, indoor units EXV have connected to indoor PCB.

**Conditions 3:** The ratio of connectable indoor units is 100%. When ambient temperature is high, operate the system in cooling mode and set the temperature 17°C(62.6°F). When ambient temperature is low, operate the system in heating mode and set the temperature 30°C(86°F). Then get the parameters after system running normally more than 30 minutes.

**Outdoor unit cooling parameters table**

Ambient temperature (T4)	°C	20-27	27-33	33-38	38-45
	°F	68-80.6	80.6-91.4	91.4-100.4	100.4-113
Discharge pressure (spot check)	MPa	2.1-2.3	2.8-3.2	3.3-3.5	3.7-3.9
	PSI	305-334	406-450	479-508	537-566
Pressure of high pressure valve	MPa	1.8-2.0	2.4-2.7	2.8-3.1	3.2-3.5
	PSI	261-290	348-392	406-450	464-508
Pressure of low pressure valve	MPa	0.7-0.9	0.8-1.0	1.0-1.2	1.2-1.4
	PSI	102-131	116-145	145-174	174-203
Discharge temperature (spot check)	°C	50-65	70-85	75-90	80-90
	°F	122-149	158-185	167-194	176-194
DC inverter compressor current (BP1/BP2)* (spot check)	A	8-13/5-11	14-17/7-11	15-18/7-12	9-11/5-7
Average temperature of evaporator outlet T2B	°C	8-9	12-15	16-17	20
	°F	46.4-48.2	53.6-59	60.8-62.6	68

**Outdoor unit heating parameters table**

Ambient temperature (T4)	°C	-15--5	-5-5	5-12	12-18
	°F	5-41	23-41	41-53.6	53.6-64.4
Discharge pressure (spot check)	MPa	2.0-2.2	2.2-2.7	3.0-3.1	2.6-2.7
	PSI	290-319	319-392	435-450	377-392
Pressure of high pressure valve	MPa	1.7-1.8	1.8-2.4	2.6-2.8	2.2-2.4
	PSI	247-261	261-348	377-406	319-348
Pressure of low pressure valve	MPa	2.0-2.2	2.2-2.6	3.0-3.1	2.6-2.7
	PSI	290-319	319-377	435-450	377-392
Discharge temperature (spot check)	°C	50-70	60-70	60-85	60-70
	°F	122-158	140-158	140-185	140-158
DC inverter compressor current (BP1/BP2)* (spot check)	A	9-12/5-7	10-12/5-8	6-8/9-10	11-15/6-9
Average temperature of condenser outlet T2	°C	33	33-40	46-50	39-41
	°F	91.4	91.4-104	114.8-122	102.2-105.8

\*BP1 is compressor E705DHD-72D2YG or E655DHD-65D2YG;

BP2 is compressor E405DHD-42D2YG or E405DHD-36D2YG, the current of E405DHD-36D2YG must less than 8A.



MUNDO  CLIMA<sup>®</sup>

**ASK FOR MORE INFORMATION**

Phone: (+34) 93 446 27 80

eMail: [info@mundoclima.com](mailto:info@mundoclima.com)

**TECHNICAL ASSISTANCE**

Phone: (+34) 93 652 53 57

[www.mundoclima.com](http://www.mundoclima.com)