

# AIR CURTAIN

User and installation manual

**MU-IN**

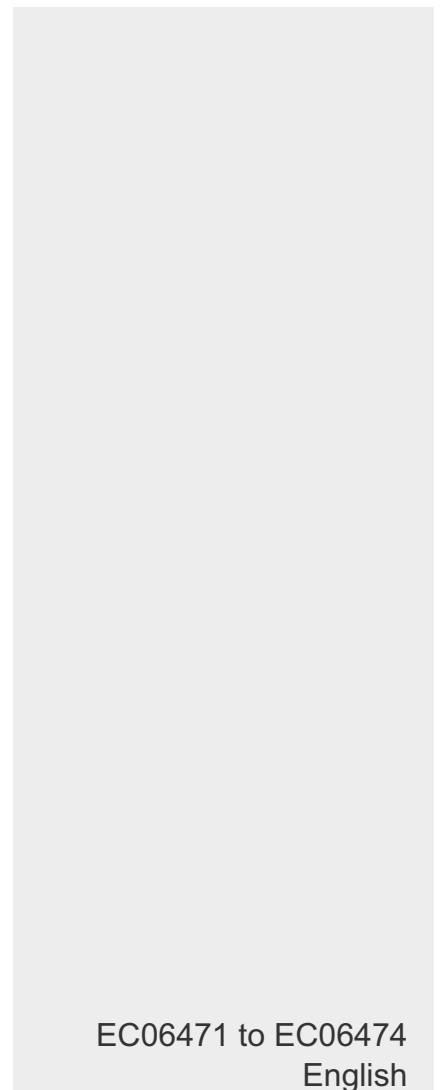

## 1. IDENTIFICATION & INSTALLATION DIMENSIONS

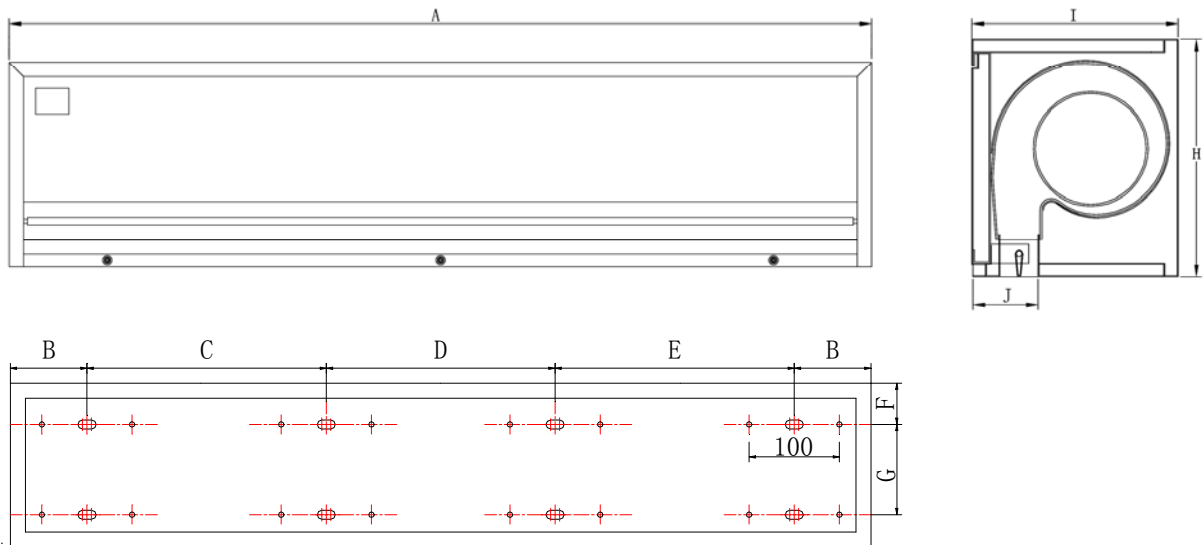

MODEL	A	B	C	D	E	F	G	H	I	J
MU-IN 09	900	95	347.5	---	347.5	64	100	240	215	70
MU-IN 12	1200	95	347.5	295	347.5					
MU-IN 15	1500		390.5	504	390.5					
MU-IN 18	1800		695	190	695					

## 2. INSTALLATION CAUTION

Must follow the following asking when installing air curtain:

2.1 Please install the unit in a sturdy place to avoid the shaking and ensure its security (because it maybe cause the wall becoming flexible or shaking and noise.

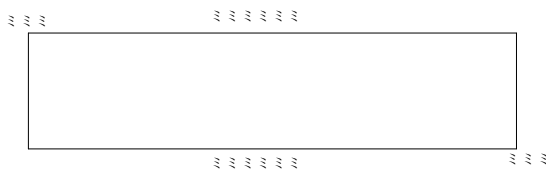

2.2 Please install the unit inside the room.

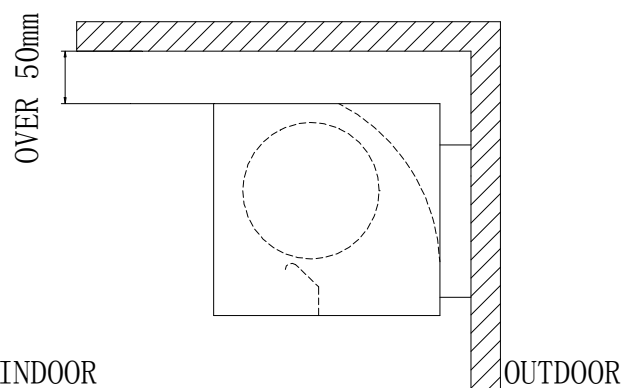

2.3 Don't install the unit too low, no less than 2.3 meter from the ground.

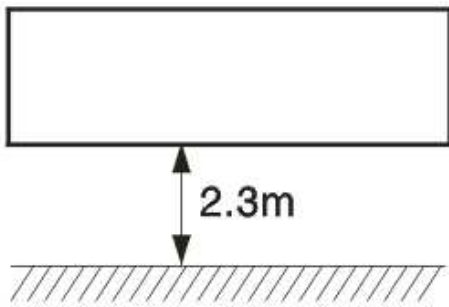

2.4 When the entrance is wider than the unit, it is recommended to install two or more units in parallel. In this case, provide 20-40mm gaps between the units.

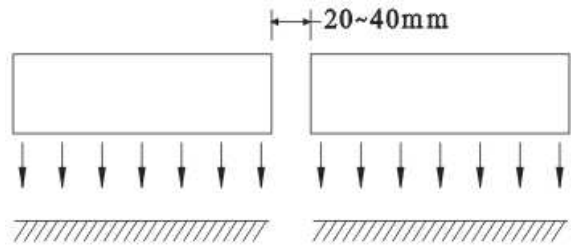

2.5 Don't allow gaps between the unit and the wall. When hanging it from the ceiling, using the enclosed ceiling brackets.

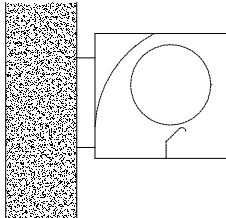

2.6 Don't install the unit in a place where it is splashed by water, exposed to excessive steam, explosive gas or corrosive gas.

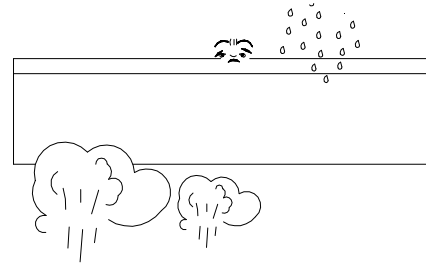

### 3. INSTALLATION

#### A. Installing on the concrete wall:

3.1.1 Removed the mounting plate  
Unclamping the fixed screws on the back of main body to removed the mounting plate.

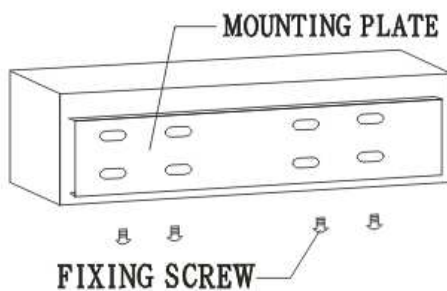

3.1.2 Fix the bolts in the proper position  
(Decide the position with the mounting plate and pour cement into the bolt holes.)

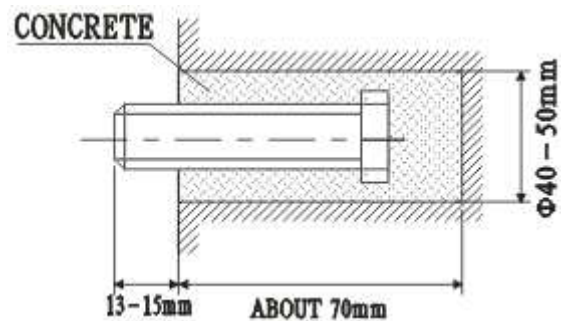

3.1.3 When the cement has freeze, fit the mounting plate (use the washer and nut according to the following)

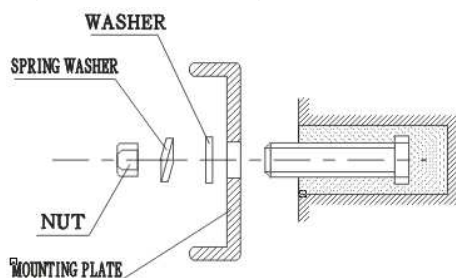

3.1.4 Install the main body  
Set the main body onto the upper end of the mounting plate and clamp it as shown.

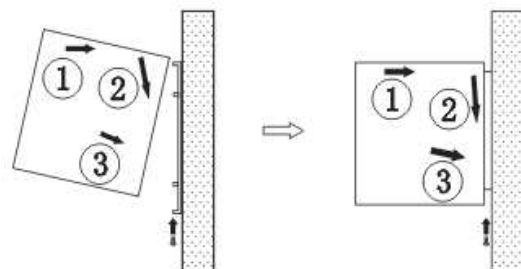

B. Installing on the wooden wall

3.2.1 Fix the mounting plate in the proper positions with tapping screw.

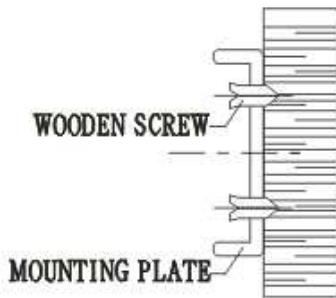

3.2.2 Same as the step 3 of A

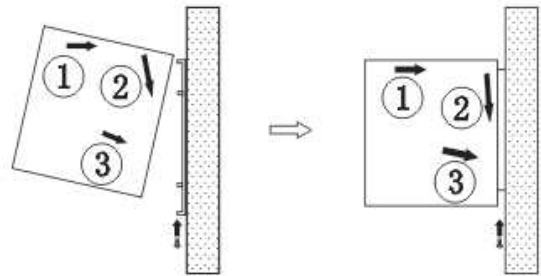

C. Hanging from the ceiling

3.3.1 Remove the mounting plate from main body (Same as step 3.1.1)

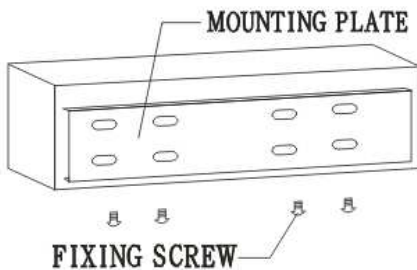

3.3.2 Fixing ceiling brackets as Fig.

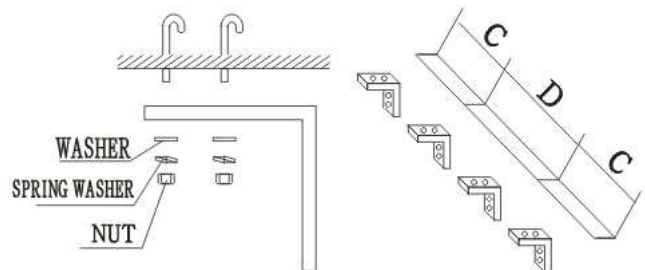

3.3.3 Set the mounting plate on the ceiling brackets and ensure safe & fixing (use the bolts attached to the ceiling brackets as Fig. Using the ceiling brackets to hang from the ceiling, the position of mounting plate can be adjusted in the limit of 100mm.

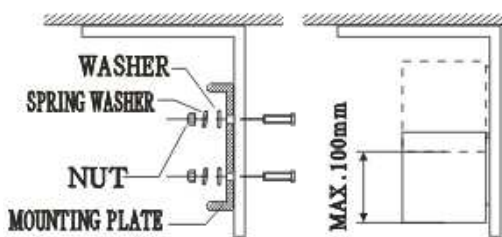

3.3.4 Do the same as step A to install the main body.

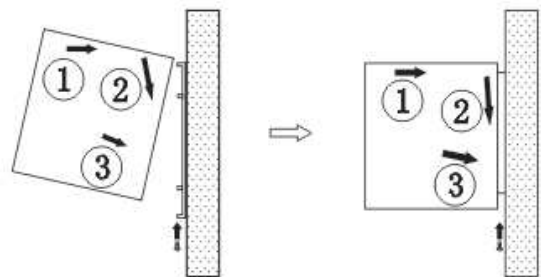

D. For above ceiling

3.4.1 Fix the air curtain as in the procedure for installing on the concrete wall.

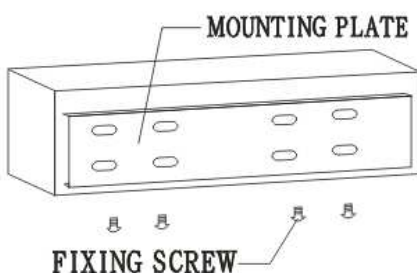

3.4.2 Then pipe as right Fig. Instructs.

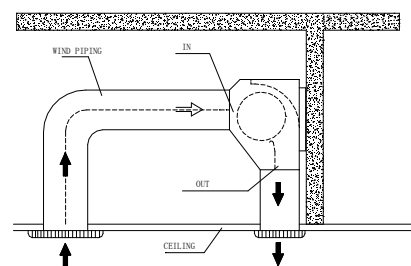

## 4. TECHNICAL PARAMETER

Model	Volt. (V~)	Freq (Hz)	Max input power (W)		Max air speed (m/s)		Air volume (m <sup>3</sup> /h)		Noise (dB)		Net weight (Kg)
			H	L	H	L	H	L	H	L	
MU-IN 09	220	50	230	200	16	13	1100	900	52	49	14
MU-IN 12			290	260			1500	1200	53	50	
MU-IN 15			380	350			1900	1500	55	52	
MU-IN 18			450	420			2280	1800	57	55	

## 5. WIRING DIAGRAM

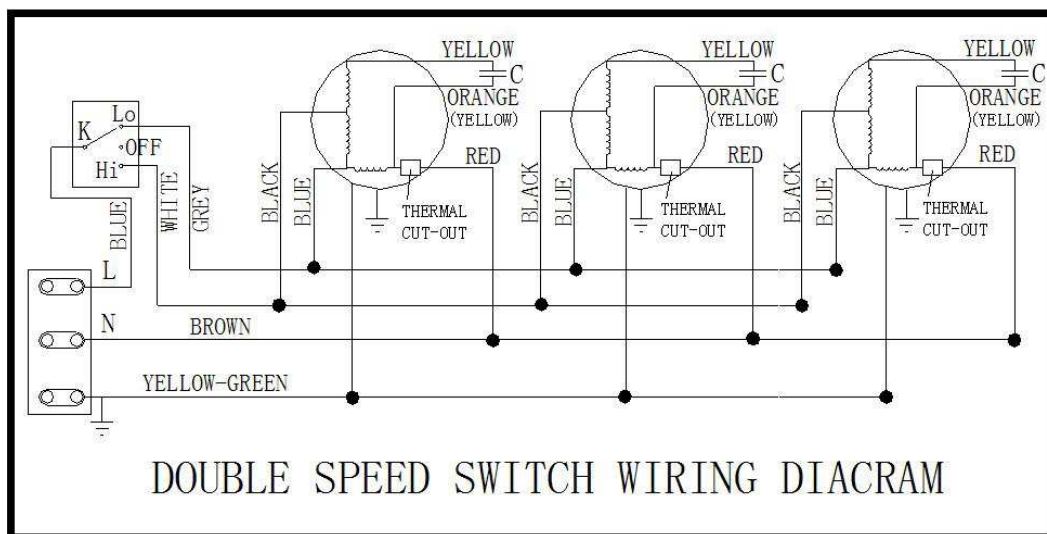

## 6. OPERATION

- 6.1 Turn on the power switch
- 6.2 Select the best speed: High[H], Low[L]
- 6.3 According to using to adjust the grate to obtain the best effect.

## 7. CAUTIONS

- a) Use the unit at the rate voltage and frequency indication on the nameplate.
- b) Disconnect power source before unit operation.
- c) Routing maintenance must be done every year.
- d) Never use petrol, benzene, thinner or any other such chemical for clearing the unit.
- e) Don't allow water or anything enter the motor.
- f) When power supply comes from socket, the plug must accord with IEC335-1. When the power cord is connected with charging line directly, all polarity switches that the contact gap is 3mm at least must be installed in the charging line.



**ASK FOR MORE INFORMATION:**

Phone: +34 93 446 27 80 - Fax: +34 93 456 90 32

eMail: [mundoclima@salvadorescoda.com](mailto:mundoclima@salvadorescoda.com)

**TECHNICAL ASSISTANCE:**

Phone: +34 93 652 53 57 - Fax: +34 93 635 45 08